

SIEMENS

SINUMERIK

SINUMERIK 840D sl/828D Turning

Operating Manual

Valid for:
SINUMERIK 840D sl / 840DE sl / 828D

Software
CNC system software for 840D sl / 840DE sl V4.8 SP3
SINUMERIK Operate for PCU/PC

Version
V4.8 SP3

08/2018
6FC5398-8CP41-0BA0

Preface

Fundamental safety instructions	1
Introduction	2
Multitouch operation with SINUMERIK Operate	3
Setting up the machine	4
Working in manual mode	5
Machining the workpiece	6
Simulating machining	7
Creating a G code program	8
Creating a ShopTurn program	9
Programming technology functions (cycles)	10
Multi-channel machining	11
Collision avoidance	12
Tool management	13
Managing programs	14
Alarm, error and system messages	15

Continued on next page

SINUMERIK 840D sl/828D Turning

Operating Manual

Continued

Working with Manual Machine	16
Working with a B axis (only 840D sl)	17
Working with two tool carriers	18
Teaching in a program	19
HT 8 (840D sl only)	20
Ctrl-Energy	21
Easy Message (828D only)	22
Easy Extend	23
Service Planner (828D only)	24
Edit PLC user program (828D only)	25
Appendix	A

Legal information

Warning notice system

This manual contains notices you have to observe in order to ensure your personal safety, as well as to prevent damage to property. The notices referring to your personal safety are highlighted in the manual by a safety alert symbol, notices referring only to property damage have no safety alert symbol. These notices shown below are graded according to the degree of danger.

 DANGER

indicates that death or severe personal injury will result if proper precautions are not taken.
--

 WARNING
--

indicates that death or severe personal injury may result if proper precautions are not taken.

 CAUTION
--

indicates that minor personal injury can result if proper precautions are not taken.
--

NOTICE

indicates that property damage can result if proper precautions are not taken.
--

If more than one degree of danger is present, the warning notice representing the highest degree of danger will be used. A notice warning of injury to persons with a safety alert symbol may also include a warning relating to property damage.

Qualified Personnel

The product/system described in this documentation may be operated only by **personnel qualified** for the specific task in accordance with the relevant documentation, in particular its warning notices and safety instructions. Qualified personnel are those who, based on their training and experience, are capable of identifying risks and avoiding potential hazards when working with these products/systems.

Proper use of Siemens products

Note the following:

 WARNING
--

Siemens products may only be used for the applications described in the catalog and in the relevant technical documentation. If products and components from other manufacturers are used, these must be recommended or approved by Siemens. Proper transport, storage, installation, assembly, commissioning, operation and maintenance are required to ensure that the products operate safely and without any problems. The permissible ambient conditions must be complied with. The information in the relevant documentation must be observed.
--

Trademarks

All names identified by ® are registered trademarks of Siemens AG. The remaining trademarks in this publication may be trademarks whose use by third parties for their own purposes could violate the rights of the owner.

Disclaimer of Liability

We have reviewed the contents of this publication to ensure consistency with the hardware and software described. Since variance cannot be precluded entirely, we cannot guarantee full consistency. However, the information in this publication is reviewed regularly and any necessary corrections are included in subsequent editions.

Preface

SINUMERIK documentation

The SINUMERIK documentation is organized into the following categories:

- General documentation/catalogs
- User documentation
- Manufacturer/service documentation

Additional information

You can find information on the following topics at the following address (<https://support.industry.siemens.com/cs/de/en/view/108464614>):

- Ordering documentation/overview of documentation
- Additional links to download documents
- Using documentation online (find and search in manuals/information)

If you have any questions regarding the technical documentation (e.g. suggestions, corrections), please send an e-mail to the following address (<mailto:docu.motioncontrol@siemens.com>).

mySupport/Documentation

At the following address (<https://support.industry.siemens.com/My/ww/en/documentation>), you can find information on how to create your own individual documentation based on Siemens' content, and adapt it for your own machine documentation.

Training

At the following address (<http://www.siemens.com/sitrain>), you can find information about SITRAIN (Siemens training on products, systems and solutions for automation and drives).

FAQs

You can find Frequently Asked Questions in the Service&Support pages under Product Support (<https://support.industry.siemens.com/cs/de/en/ps/faq>).

SINUMERIK

You can find information about SINUMERIK at the following address (<http://www.siemens.com/sinumerik>).

Target group

This documentation is intended for users of turning machines running the SINUMERIK Operate software.

Benefits

The operating manual helps users familiarize themselves with the control elements and commands. Guided by the manual, users are capable of responding to problems and taking corrective action.

Standard scope

This documentation describes the functionality of the standard scope. Extensions or changes made by the machine manufacturer are documented by the machine manufacturer.

Other functions not described in this documentation might be executable in the control. However, no claim can be made regarding the availability of these functions when the equipment is first supplied or in the event of servicing.

Furthermore, for the sake of clarity, this documentation does not contain all detailed information about all types of the product and cannot cover every conceivable case of installation, operation or maintenance.

Terms

The meanings of some basic terms used in this documentation are given below.

Program

A program is a sequence of instructions to the CNC which combine to produce a specific workpiece on the machine.

Contour

The term contour refers generally to the outline of a workpiece. More specifically, it refers to the section of the program that defines the outline of a workpiece comprising individual elements.

Cycle

A cycle, such as the tapping cycle, is a subprogram defined in SINUMERIK Operate for executing a frequently repeated machining operation.

Technical Support

Country-specific telephone numbers for technical support are provided in the Internet at the following address (<https://support.industry.siemens.com/sc/ww/en/sc/2090>) in the "Contact" area.

Table of contents

	Preface	5
1	Fundamental safety instructions	23
1.1	General safety instructions.....	23
1.2	Warranty and liability for application examples.....	24
1.3	Industrial security.....	25
2	Introduction	27
2.1	Product overview.....	27
2.2	Operator panel fronts.....	28
2.2.1	Overview.....	28
2.2.2	Keys of the operator panel.....	30
2.3	Machine control panels.....	38
2.3.1	Overview.....	38
2.3.2	Controls on the machine control panel.....	38
2.4	User interface.....	42
2.4.1	Screen layout.....	42
2.4.2	Status display.....	43
2.4.3	Actual value window.....	45
2.4.4	T,F,S window.....	47
2.4.5	Current block display.....	48
2.4.6	Operation via softkeys and buttons.....	50
2.4.7	Entering or selecting parameters.....	51
2.4.8	Pocket calculator.....	53
2.4.9	Pocket calculator functions.....	54
2.4.10	Context menu.....	56
2.4.11	Changing the user interface language.....	57
2.4.12	Entering Chinese characters.....	57
2.4.12.1	Function - input editor.....	57
2.4.12.2	Entering Asian characters.....	59
2.4.12.3	Editing the dictionary.....	60
2.4.13	Entering Korean characters.....	62
2.4.14	Protection levels.....	64
2.4.15	Online help in SINUMERIK Operate.....	66
3	Multitouch operation with SINUMERIK Operate	69
3.1	Multitouch panels.....	69
3.2	Touch-sensitive user interface.....	70
3.3	Finger gestures.....	71
3.4	Multitouch user interface.....	74
3.4.1	Screen layout.....	74
3.4.2	Function key block.....	74

3.4.3	Further operator touch controls.....	75
3.4.4	Virtual keyboard.....	76
3.4.5	Special "tilde" character.....	76
3.5	Expansion with side screen.....	77
3.5.1	Overview.....	77
3.5.2	Sidescreen with standard windows.....	77
3.5.3	Standard widgets.....	79
3.5.4	"Actual value" widget.....	79
3.5.5	"Zero point" widget.....	80
3.5.6	"Alarms" widget.....	80
3.5.7	"Axle load" widget.....	80
3.5.8	"Tool" widget.....	81
3.5.9	"Service life" widget.....	81
3.5.10	"Program runtime" widget.....	82
3.5.11	Sidescreen with pages for the ABC keyboard and/or machine control panel.....	82
3.5.12	Example 1: ABC keyboard in the sidescreen.....	83
3.5.13	Example 2: Machine control panel in the sidescreen.....	84
3.6	SINUMERIK Operate Display Manager (840D sl only).....	85
3.6.1	Overview.....	85
3.6.2	Screen layout.....	86
3.6.3	Operator controls.....	86
4	Setting up the machine.....	89
4.1	Switching on and switching off.....	89
4.2	Approaching a reference point.....	90
4.2.1	Referencing axes.....	90
4.2.2	User agreement.....	91
4.3	Modes and mode groups.....	93
4.3.1	General.....	93
4.3.2	Modes groups and channels.....	94
4.3.3	Channel switchover.....	95
4.4	Settings for the machine.....	96
4.4.1	Switching over the coordinate system (MCS/WCS).....	96
4.4.2	Switching the unit of measurement.....	96
4.4.3	Setting the zero offset.....	98
4.5	Measuring the tool.....	100
4.5.1	Measuring a tool manually.....	100
4.5.2	Measuring a tool with a tool probe.....	102
4.5.3	Calibrating the tool probe.....	104
4.5.4	Measuring a tool with a magnifying glass.....	105
4.5.5	Logging tool measurement results.....	106
4.6	Measuring the workpiece zero.....	107
4.6.1	Measuring the workpiece zero.....	107
4.6.2	Logging measurement results for the workpiece zero.....	108
4.7	Settings for the measurement result log.....	110
4.8	Zero offsets.....	112
4.8.1	Display active zero offset.....	113
4.8.2	Displaying the zero offset "overview".....	113

4.8.3	Displaying and editing base zero offset.....	114
4.8.4	Displaying and editing settable zero offset.....	115
4.8.5	Displaying and editing details of the zero offsets.....	116
4.8.6	Deleting a zero offset.....	118
4.8.7	Measuring the workpiece zero.....	118
4.9	Monitoring axis and spindle data.....	120
4.9.1	Specify working area limitations.....	120
4.9.2	Editing spindle data.....	120
4.9.3	Spindle chuck data.....	121
4.10	Displaying setting data lists.....	125
4.11	Handwheel assignment.....	126
4.12	MDA.....	128
4.12.1	Loading an MDA program from the Program Manager.....	128
4.12.2	Saving an MDA program.....	129
4.12.3	Editing/executing a MDI program.....	130
4.12.4	Deleting an MDA program.....	131
5	Working in manual mode.....	133
5.1	General.....	133
5.2	Selecting a tool and spindle.....	134
5.2.1	T,S,M window.....	134
5.2.2	Selecting a tool.....	135
5.2.3	Starting and stopping the spindle manually.....	136
5.2.4	Positioning the spindle.....	137
5.3	Traversing axes.....	138
5.3.1	Traverse axes by a defined increment.....	138
5.3.2	Traversing axes by a variable increment.....	139
5.4	Positioning axes.....	140
5.5	Manual retraction.....	141
5.6	Simple stock removal of workpiece.....	143
5.7	Thread synchronizing.....	146
5.8	Default settings for manual mode.....	148
6	Machining the workpiece.....	149
6.1	Starting and stopping machining.....	149
6.2	Selecting a program.....	151
6.3	Executing a trail program run.....	152
6.4	Displaying the current program block.....	154
6.4.1	Current block display.....	154
6.4.2	Displaying a basic block.....	155
6.4.3	Display program level.....	156
6.5	Correcting a program.....	158
6.6	Repositioning axes.....	159
6.7	Starting machining at a specific point.....	160

6.7.1	Use block search.....	160
6.7.2	Continuing program from search target.....	162
6.7.3	Simple search target definition.....	162
6.7.4	Defining an interruption point as search target.....	163
6.7.5	Entering the search target via search pointer.....	163
6.7.6	Parameters for block search in the search pointer.....	164
6.7.7	Block search mode.....	165
6.7.8	Block search for position pattern for ShopTurn programs.....	167
6.8	Controlling the program run.....	169
6.8.1	Program control.....	169
6.8.2	Skip blocks.....	170
6.9	Overstore.....	172
6.10	Editing a program.....	174
6.10.1	Searching in programs.....	174
6.10.2	Replacing program text.....	176
6.10.3	Copying/pasting/deleting a program block.....	177
6.10.4	Renumbering a program.....	179
6.10.5	Creating a program block.....	180
6.10.6	Opening additional programs.....	181
6.10.7	Editor settings.....	182
6.11	Working with DXF files.....	186
6.11.1	Overview.....	186
6.11.2	Displaying CAD drawings.....	186
6.11.2.1	Open a DXF file.....	186
6.11.2.2	Cleaning a DXF file.....	186
6.11.2.3	Enlarging or reducing the CAD drawing.....	187
6.11.2.4	Changing the section.....	188
6.11.2.5	Rotating the view.....	188
6.11.2.6	Displaying/editing information for the geometric data.....	189
6.11.3	Importing and editing a DXF file in the editor.....	190
6.11.3.1	General procedure.....	190
6.11.3.2	Specifying a reference point.....	190
6.11.3.3	Assigning the machining plane.....	191
6.11.3.4	Setting the tolerance.....	191
6.11.3.5	Selecting the machining range / deleting the range and element.....	192
6.11.3.6	Saving the DXF file.....	193
6.11.3.7	Transferring the drilling positions.....	194
6.11.3.8	Accepting contours.....	196
6.12	Display and edit user variables.....	199
6.12.1	Overview.....	199
6.12.2	Global R parameters.....	200
6.12.3	R parameters.....	201
6.12.4	Displaying global user data (GUD).....	203
6.12.5	Displaying channel GUDs.....	204
6.12.6	Displaying local user data (LUD).....	205
6.12.7	Displaying program user data (PUD).....	206
6.12.8	Searching for user variables.....	206
6.13	Displaying G functions and auxiliary functions.....	209
6.13.1	Selected G functions.....	209

6.13.2	All G functions.....	211
6.13.3	G functions for mold making.....	211
6.13.4	Auxiliary functions.....	212
6.14	Displaying superimpositions.....	214
6.15	Mold making view.....	217
6.15.1	Starting the mold making view.....	219
6.15.2	Adapting the mold making view.....	219
6.15.3	Specifically jump to the program block.....	220
6.15.4	Searching for program blocks.....	221
6.15.5	Changing the view.....	222
6.15.5.1	Enlarging or reducing the graphical representation.....	222
6.15.5.2	Moving and rotating the graphic.....	223
6.15.5.3	Modifying the viewport.....	223
6.16	Displaying the program runtime and counting workpieces.....	225
6.17	Setting for automatic mode.....	227
7	Simulating machining.....	231
7.1	Overview.....	231
7.2	Simulation before machining of the workpiece.....	237
7.3	Simultaneous recording before machining of the workpiece.....	239
7.4	Simultaneous recording during machining of the workpiece.....	240
7.5	Different views of the workpiece.....	241
7.5.1	Side view.....	241
7.5.2	Half section.....	242
7.5.3	Face view.....	242
7.5.4	3D view.....	242
7.5.5	2-window.....	243
7.6	Graphical display.....	244
7.7	Editing the simulation display.....	245
7.7.1	Blank display.....	245
7.7.2	Showing and hiding the tool path	246
7.8	Program control during the simulation.....	248
7.8.1	Changing the feedrate	248
7.8.2	Simulating the program block by block.....	249
7.9	Editing and adapting a simulation graphic	250
7.9.1	Enlarging or reducing the graphical representation.....	250
7.9.2	Panning a graphical representation.....	251
7.9.3	Rotating the graphical representation.....	251
7.9.4	Modifying the viewport.....	252
7.9.5	Defining cutting planes.....	252
7.10	Displaying simulation alarms.....	254
8	Creating a G code program.....	255
8.1	Graphical programming.....	255
8.2	Program views.....	256

8.3	Program structure.....	261
8.4	Fundamentals.....	262
8.4.1	Machining planes.....	262
8.4.2	Current planes in cycles and input screens.....	262
8.4.3	Programming a tool (T).....	263
8.5	Generating a G code program.....	264
8.6	Blank input.....	265
8.7	Machining plane, milling direction, retraction plane, safe clearance and feedrate (PL, RP, SC, F).....	268
8.8	Selection of the cycles via softkey.....	269
8.9	Calling technology cycles.....	273
8.9.1	Hiding cycle parameters.....	273
8.9.2	Setting data for cycles.....	273
8.9.3	Checking cycle parameters.....	273
8.9.4	Programming variables.....	274
8.9.5	Changing a cycle call.....	274
8.9.6	Compatibility for cycle support.....	275
8.9.7	Additional functions in the input screens.....	275
8.10	Measuring cycle support.....	277
9	Creating a ShopTurn program.....	279
9.1	Graphic program control, ShopTurn programs.....	279
9.2	Program views.....	280
9.3	Program structure.....	286
9.4	Fundamentals.....	287
9.4.1	Machining planes.....	287
9.4.2	Machining cycle, approach/retraction.....	288
9.4.3	Absolute and incremental dimensions.....	290
9.4.4	Polar coordinates.....	292
9.4.5	Clamping the spindle.....	293
9.5	Creating a ShopTurn program.....	294
9.6	Program header.....	296
9.7	Generating program blocks.....	299
9.8	Tool, offset value, feedrate and spindle speed (T, D, F, S, V).....	300
9.9	Call work offsets.....	303
9.10	Repeating program blocks.....	304
9.11	Entering the number of workpieces.....	306
9.12	Changing program blocks.....	307
9.13	Changing program settings.....	308
9.14	Selection of the cycles via softkey.....	310
9.15	Calling technology functions.....	315

9.15.1	Additional functions in the input screens.....	315
9.15.2	Checking cycle parameters.....	315
9.15.3	Setting data for technological functions.....	315
9.15.4	Programming variables.....	316
9.15.5	Changing a cycle call.....	316
9.15.6	Compatibility for cycle support.....	317
9.16	Programming the approach/retraction cycle.....	318
9.17	Measuring cycle support.....	320
9.18	Example: Standard machining.....	321
9.18.1	Workpiece drawing.....	322
9.18.2	Programming.....	322
9.18.3	Results/simulation test.....	334
9.18.4	G code machining program.....	336
10	Programming technology functions (cycles).....	339
10.1	Drilling.....	339
10.1.1	General.....	339
10.1.2	Centering (CYCLE81).....	340
10.1.3	Drilling (CYCLE82).....	342
10.1.4	Reaming (CYCLE85).....	346
10.1.5	Boring (CYCLE86).....	349
10.1.6	Deep-hole drilling 1 (CYCLE83).....	351
10.1.7	Deep-hole drilling 2 (CYCLE830).....	357
10.1.8	Tapping (CYCLE84, 840).....	367
10.1.9	Drill and thread milling (CYCLE78).....	375
10.1.10	Positions and position patterns.....	378
10.1.11	Arbitrary positions (CYCLE802).....	380
10.1.12	Row position pattern (HOLES1).....	384
10.1.13	Grid or frame position pattern (CYCLE801).....	387
10.1.14	Circle or pitch circle position pattern (HOLES2).....	391
10.1.15	Displaying and hiding positions.....	397
10.1.16	Repeating positions.....	398
10.2	Rotate.....	400
10.2.1	General.....	400
10.2.2	Stock removal (CYCLE951).....	400
10.2.3	Groove (CYCLE930).....	403
10.2.4	Undercut form E and F (CYCLE940).....	406
10.2.5	Thread undercuts (CYCLE940).....	408
10.2.6	Thread turning (CYCLE99).....	411
10.2.7	Thread chain (CYCLE98).....	428
10.2.8	Cut-off (CYCLE92).....	434
10.3	Contour turning.....	436
10.3.1	General information.....	436
10.3.2	Representation of the contour.....	437
10.3.3	Creating a new contour.....	438
10.3.4	Creating contour elements.....	440
10.3.5	Entering the master dimension.....	446
10.3.6	Changing the contour.....	447
10.3.7	Contour call (CYCLE62) - only for G code program.....	448
10.3.8	Stock removal (CYCLE952).....	449

10.3.9	Stock removal rest (CYCLE952).....	459
10.3.10	Plunge-cutting (CYCLE952).....	461
10.3.11	Plunge-cutting rest (CYCLE952).....	467
10.3.12	Plunge-turning (CYCLE952).....	469
10.3.13	Plunge-turning rest (CYCLE952).....	476
10.4	Milling.....	478
10.4.1	Face milling (CYCLE61).....	478
10.4.2	Rectangular pocket (POCKET3).....	481
10.4.3	Circular pocket (POCKET4).....	491
10.4.4	Rectangular spigot (CYCLE76).....	500
10.4.5	Circular spigot (CYCLE77).....	506
10.4.6	Multi-edge (CYCLE79).....	512
10.4.7	Longitudinal groove (SLOT1).....	517
10.4.8	Circumferential groove (SLOT2).....	526
10.4.9	Open groove (CYCLE899).....	534
10.4.10	Long hole (LONGHOLE) - only for G code program.....	544
10.4.11	Thread milling (CYCLE70).....	546
10.4.12	Engraving (CYCLE60).....	551
10.5	Contour milling.....	557
10.5.1	General information.....	557
10.5.2	Representation of the contour.....	557
10.5.3	Creating a new contour.....	558
10.5.4	Creating contour elements.....	561
10.5.5	Changing the contour.....	566
10.5.6	Contour call (CYCLE62) - only for G code program.....	567
10.5.7	Path milling (CYCLE72).....	568
10.5.8	Contour pocket/contour spigot (CYCLE63/64).....	574
10.5.9	Predrilling contour pocket (CYCLE64).....	576
10.5.10	Milling contour pocket (CYCLE63).....	580
10.5.11	Contour pocket residual material (CYCLE63, option).....	586
10.5.12	Milling contour spigot (CYCLE63).....	588
10.5.13	Contour spigot residual material (CYCLE63, option).....	593
10.6	Further cycles and functions.....	597
10.6.1	Swiveling plane / aligning tool (CYCLE800).....	597
10.6.2	Swiveling tool (CYCLE800).....	604
10.6.2.1	Aligning turning tools - only for G code program (CYCLE800).....	604
10.6.2.2	Aligning milling tools - only for G code program (CYCLE800).....	607
10.6.2.3	Preloading milling tools - only for G code program (CYCLE800).....	607
10.6.3	High-speed settings (CYCLE832).....	609
10.6.3.1	Parameters.....	611
10.6.4	Subroutines.....	612
10.7	Additional cycles and functions in ShopTurn.....	615
10.7.1	Drilling centric.....	615
10.7.2	Thread centered.....	618
10.7.3	Transformations.....	621
10.7.4	Translation.....	623
10.7.5	Rotation.....	624
10.7.6	Scaling.....	625
10.7.7	Mirroring.....	625
10.7.8	Rotation C.....	626

10.7.9	Straight and circular machining.....	627
10.7.10	Selecting a tool and machining plane.....	628
10.7.11	Programming a straight line.....	629
10.7.12	Programming a circle with known center point.....	631
10.7.13	Programming a circle with known radius.....	633
10.7.14	Polar coordinates.....	635
10.7.15	Straight line polar.....	636
10.7.16	Circle polar.....	638
10.7.17	Machining with movable counterspindle.....	639
10.7.17.1	Programming example: Machining main spindle – Transfer workpiece – Machining counterspindle.....	640
10.7.17.2	Programming example: Machining counter-spindle – Transfer workpiece – Machining main spindle.....	641
10.7.17.3	Programming example: Machining, counterspindle - without previous transfer.....	641
10.7.17.4	Programming example: Machining bar material.....	642
10.7.18	Machining with fixed counterspindle.....	647
11	Multi-channel machining.....	651
11.1	Multi-channel view.....	651
11.1.1	Multi-channel view in the "Machine" operating area.....	651
11.1.2	Multi-channel view for large operator panels.....	653
11.1.3	Setting the multi-channel view.....	655
11.2	Multi-channel support.....	657
11.2.1	Working with several channels.....	657
11.2.2	Creating a multi-channel program.....	658
11.2.3	Entering multi-channel data.....	658
11.2.4	Multi-channel functionality for large operator panels.....	662
11.2.5	Editing the multi-channel program.....	664
11.2.5.1	Changing the job list.....	664
11.2.5.2	Editing a G code multi-channel program.....	665
11.2.5.3	Editing a ShopTurn multi-channel program.....	667
11.2.5.4	Creating a program block.....	674
11.2.6	Setting the multi-channel function.....	676
11.2.7	Synchronizing programs.....	677
11.2.8	Insert WAIT marks.....	680
11.2.9	Optimizing the machining time.....	681
11.2.10	Automatic block building.....	683
11.2.10.1	Creating automated program blocks.....	683
11.2.10.2	Editing a converted program.....	685
11.2.11	Simulating machining.....	686
11.2.11.1	Simulation.....	686
11.2.11.2	Different workpiece views for multi-channel support.....	687
11.2.12	Display/edit the multi-channel functionality in the "Machine" operating area.....	688
11.2.12.1	Running-in a program.....	688
11.2.12.2	Block search and program control.....	689
11.2.13	Stock removal with 2 synchronized channels.....	690
11.2.13.1	Job list.....	692
11.2.13.2	Stock removal.....	694
11.2.14	Synchronizing a counterspindle	695
12	Collision avoidance.....	701
12.1	Activating collision avoidance.....	703

12.2	Set collision avoidance.....	704
13	Tool management.....	707
13.1	Lists for the tool management.....	707
13.2	Magazine management.....	709
13.3	Tool types.....	710
13.4	Tool dimensioning.....	713
13.5	Tool list.....	718
13.5.1	Additional data.....	721
13.5.2	Creating a new tool.....	722
13.5.3	Measuring the tool.....	724
13.5.4	Managing several cutting edges.....	725
13.5.5	Delete tool.....	725
13.5.6	Loading and unloading tools.....	726
13.5.7	Selecting a magazine.....	727
13.5.8	Code carrier connection (only 840D sl).....	728
13.5.8.1	Overview.....	728
13.5.9	Managing a tool in a file.....	730
13.6	Tool wear.....	733
13.6.1	Reactivate tool.....	735
13.7	Tool data OEM.....	737
13.8	Magazine.....	738
13.8.1	Positioning a magazine.....	740
13.8.2	Relocating a tool.....	740
13.8.3	Delete/unload/load/relocate all tools.....	741
13.9	Tool details.....	743
13.9.1	Displaying tool details.....	743
13.9.2	Tool data.....	743
13.9.3	Cutting edge data.....	744
13.9.4	Monitoring data.....	746
13.10	Sorting tool management lists.....	747
13.11	Filtering the tool management lists.....	748
13.12	Specific search in the tool management lists.....	750
13.13	Changing the cutting edge position or tool type.....	752
13.14	Settings for tool lists.....	753
13.15	Working with multitool.....	755
13.15.1	Tool list for multitool.....	755
13.15.2	Create multitool.....	756
13.15.3	Equipping multitool with tools.....	758
13.15.4	Removing a tool from multitool.....	759
13.15.5	Delete multitool.....	760
13.15.6	Loading and unloading multitool.....	760
13.15.7	Reactivating the multitool.....	761
13.15.8	Relocating a multitool.....	762
13.15.9	Positioning multitool.....	763

14	Managing programs.....	765
14.1	Overview.....	765
14.1.1	NC memory.....	768
14.1.2	Local drive.....	768
14.1.3	USB drives.....	769
14.1.4	FTP drive.....	770
14.2	Opening and closing the program.....	772
14.3	Executing a program.....	774
14.4	Creating a directory / program / job list / program list.....	776
14.4.1	File and directory names.....	776
14.4.2	Creating a new directory.....	776
14.4.3	Creating a new workpiece.....	777
14.4.4	Creating a new G code program.....	778
14.4.5	New ShopTurn program.....	778
14.4.6	Storing any new file.....	779
14.4.7	Creating a job list.....	780
14.4.8	Creating a program list.....	782
14.5	Creating templates.....	783
14.6	Searching directories and files.....	784
14.7	Displaying the program in the Preview.....	786
14.8	Selecting several directories/programs.....	787
14.9	Copying and pasting a directory/program.....	789
14.10	Deleting a directory/program.....	791
14.11	Changing file and directory properties.....	792
14.12	Set up drives.....	794
14.12.1	Overview.....	794
14.12.2	Setting up drives.....	794
14.13	Viewing PDF documents.....	801
14.14	EXTCALL.....	803
14.15	Execution from external memory (EES).....	805
14.16	Backing up data.....	806
14.16.1	Generating an archive in the Program Manager.....	806
14.16.2	Generating an archive via the system data.....	807
14.16.3	Reading in an archive in the Program Manager.....	809
14.16.4	Read in archive from system data.....	810
14.17	Setup data.....	812
14.17.1	Backing up setup data.....	812
14.17.2	Reading-in set-up data.....	814
14.18	Backing up parameters.....	816
14.19	RS-232-C.....	819
14.19.1	Reading-in and reading-out archives via a serial interface.....	819
14.19.2	Setting V24 in the program manager.....	821

15	Alarm, error and system messages.....	823
15.1	Displaying alarms.....	823
15.2	Displaying an alarm log.....	826
15.3	Displaying messages.....	827
15.4	Sorting, alarms, faults and messages.....	828
15.5	Creating screenshots.....	829
15.6	PLC and NC variables.....	830
15.6.1	Displaying and editing PLC and NC variables.....	830
15.6.2	Saving and loading screen forms.....	834
15.7	Version.....	835
15.7.1	Displaying version data.....	835
15.7.2	Save information.....	836
15.8	Logbook.....	837
15.8.1	Displaying and editing the logbook.....	837
15.8.2	Making a logbook entry.....	838
15.9	Remote diagnostics.....	840
15.9.1	Setting remote access.....	840
15.9.2	Permit modem.....	841
15.9.3	Request remote diagnostics.....	842
15.9.4	Exit remote diagnostics.....	843
16	Working with Manual Machine.....	845
16.1	Manual Machine.....	845
16.2	Measuring the tool.....	847
16.3	Setting the zero offset.....	848
16.4	Set limit stop.....	849
16.5	Simple workpiece machining.....	850
16.5.1	Traversing axes.....	850
16.5.2	Taper turning.....	851
16.5.3	Straight and circular machining.....	852
16.5.3.1	Straight turning.....	852
16.5.3.2	Circular turning.....	853
16.6	More complex machining.....	855
16.6.1	Drilling with Manual Machine.....	856
16.6.2	Turning with manual machine.....	857
16.6.3	Contour turning with Manual machine.....	859
16.6.4	Milling with Manual Machine.....	860
16.7	Simulation and simultaneous recording.....	861
17	Working with a B axis (only 840D sl).....	863
17.1	Lathes with B axis.....	863
17.2	Tool alignment for turning.....	866
17.3	Milling with a B axis.....	867

17.4	Swiveling.....	868
17.5	Approach/retraction.....	870
17.6	Position pattern.....	872
17.7	Tool selection for the manual mode.....	874
17.8	Measuring a tool with the B axis.....	875
18	Working with two tool carriers.....	877
18.1	Programming with two tool holders.....	878
18.2	Measure tool.....	879
19	Teaching in a program.....	881
19.1	Overview.....	881
19.2	General sequence.....	882
19.3	Inserting a block.....	883
19.3.1	Input parameters for teach-in blocks.....	883
19.4	Teach-in via Windows.....	885
19.4.1	General.....	885
19.4.2	Teach in rapid traverse G0.....	886
19.4.3	Teach in straight G1.....	886
19.4.4	Teaching in circle intermediate and circle end point CIP.....	886
19.4.5	Teach-in A spline.....	887
19.5	Editing a block.....	889
19.6	Selecting a block.....	890
19.7	Deleting a block.....	891
19.8	Settings for teach-in.....	892
20	HT 8 (840D sl only).....	893
20.1	HT 8 overview.....	893
20.2	Traversing keys.....	896
20.3	Machine control panel menu.....	897
20.4	Virtual keyboard.....	899
20.5	Calibrating the touch panel.....	901
21	Ctrl-Energy.....	903
21.1	Functions.....	903
21.2	Ctrl-E analysis.....	904
21.2.1	Displaying energy consumption.....	904
21.2.2	Displaying the energy analyses.....	905
21.2.3	Measuring and saving the energy consumption.....	906
21.2.4	Tracking measurements.....	907
21.2.5	Tracking usage values.....	908
21.2.6	Comparing usage values.....	908
21.2.7	Long-term measurement of the energy consumption.....	909

21.3	Ctrl-E profiles.....	911
21.3.1	Using the energy-saving profile.....	911
22	Easy Message (828D only).....	913
22.1	Overview.....	913
22.2	Activating Easy Message.....	914
22.3	Creating/editing a user profile.....	915
22.4	Setting-up events.....	917
22.5	Logging an active user on and off.....	919
22.6	Displaying SMS logs.....	920
22.7	Making settings for Easy Message.....	921
23	Easy Extend.....	923
23.1	Overview.....	923
23.2	Enabling a device.....	924
23.3	Activating and deactivating a device.....	925
23.4	Initial commissioning of additional devices.....	926
24	Service Planner (828D only).....	927
24.1	Performing and monitoring maintenance tasks.....	927
25	Edit PLC user program (828D only).....	929
25.1	Introduction.....	929
25.2	Displaying and editing PLC properties.....	930
25.2.1	Displaying PLC properties.....	930
25.2.2	Resetting the processing time.....	930
25.2.3	Loading modified PLC user program.....	930
25.3	Displaying and editing PLC and NC variables.....	932
25.4	Displaying and editing PLC signals in the status list.....	937
25.5	View of the program blocks.....	938
25.5.1	Displaying information on the program blocks.....	938
25.5.2	Structure of the user interface.....	939
25.5.3	Control options.....	940
25.5.4	Displaying the program status.....	941
25.5.5	Changing the address display.....	942
25.5.6	Enlarging/reducing the ladder diagram.....	942
25.5.7	Program block.....	943
25.5.7.1	Displaying and editing the program block.....	943
25.5.7.2	Displaying local variable table.....	944
25.5.7.3	Creating a program block.....	944
25.5.7.4	Opening a program block in the window.....	946
25.5.7.5	Displaying/canceling the access protection.....	946
25.5.7.6	Editing block properties subsequently.....	947
25.5.8	Editing a program block.....	947
25.5.8.1	Editing the PLC user program.....	947

25.5.8.2	Editing a program block.....	948
25.5.8.3	Deleting a program block.....	950
25.5.8.4	Inserting and editing networks.....	950
25.5.8.5	Editing network properties.....	951
25.5.9	Displaying the network symbol information table.....	952
25.6	Displaying symbol tables.....	953
25.7	Displaying cross references.....	954
25.8	Searching for operands.....	955
A	Appendix.....	957
A.1	840D sl / 828D documentation overview.....	957
	Index.....	959

Fundamental safety instructions

1.1 General safety instructions

 WARNING
Danger to life if the safety instructions and residual risks are not observed
If the safety instructions and residual risks in the associated hardware documentation are not observed, accidents involving severe injuries or death can occur.
<ul style="list-style-type: none">• Observe the safety instructions given in the hardware documentation.• Consider the residual risks for the risk evaluation.

 WARNING
Malfunctions of the machine as a result of incorrect or changed parameter settings
As a result of incorrect or changed parameterization, machines can malfunction, which in turn can lead to injuries or death.
<ul style="list-style-type: none">• Protect the parameterization (parameter assignments) against unauthorized access.• Handle possible malfunctions by taking suitable measures, e.g. emergency stop or emergency off.

1.2 Warranty and liability for application examples

Application examples are not binding and do not claim to be complete regarding configuration, equipment or any eventuality which may arise. Application examples do not represent specific customer solutions, but are only intended to provide support for typical tasks.

As the user you yourself are responsible for ensuring that the products described are operated correctly. Application examples do not relieve you of your responsibility for safe handling when using, installing, operating and maintaining the equipment.

1.3 Industrial security

Note

Industrial security

Siemens provides products and solutions with industrial security functions that support the secure operation of plants, systems, machines and networks.

In order to protect plants, systems, machines and networks against cyber threats, it is necessary to implement – and continuously maintain – a holistic, state-of-the-art industrial security concept. Siemens' products and solutions constitute one element of such a concept.

Customers are responsible for preventing unauthorized access to their plants, systems, machines and networks. Such systems, machines and components should only be connected to an enterprise network or the Internet if and to the extent such a connection is necessary and only when appropriate security measures (e.g. firewalls and/or network segmentation) are in place.

For additional information on industrial security measures that may be implemented, please visit:

Industrial security (<http://www.siemens.com/industrialsecurity>)

Siemens' products and solutions undergo continuous development to make them more secure. Siemens strongly recommends that product updates are applied as soon as they are available and that the latest product versions are used. Use of product versions that are no longer supported, and failure to apply the latest updates may increase customer's exposure to cyber threats.

To stay informed about product updates, subscribe to the Siemens Industrial Security RSS Feed at:

Industrial security (<http://www.siemens.com/industrialsecurity>)

Further information is provided on the Internet:

Industrial Security Configuration Manual (<https://support.industry.siemens.com/cs/ww/en/view/108862708>)

 **WARNING**

Unsafe operating states resulting from software manipulation

Software manipulations (e.g. viruses, trojans, malware or worms) can cause unsafe operating states in your system that may lead to death, serious injury, and property damage.

- Keep the software up to date.
- Incorporate the automation and drive components into a holistic, state-of-the-art industrial security concept for the installation or machine.
- Make sure that you include all installed products into the holistic industrial security concept.
- Protect files stored on exchangeable storage media from malicious software by with suitable protection measures, e.g. virus scanners.
- Protect the drive against unauthorized changes by activating the "know-how protection" drive function.

Introduction

2.1 Product overview

The SINUMERIK control system is a CNC (Computerized Numerical Control) for machine tools. You can use the CNC to implement the following basic functions in conjunction with a machine tool:

- Create can adapt part programs
- Execute part programs
- Manual control
- Access internal and external data media
- Edit data for programs
- Manage tools, zero points and further user data required in programs
- Diagnose control system and machine

Operating areas

The basic functions are grouped in the following operating areas in the control:

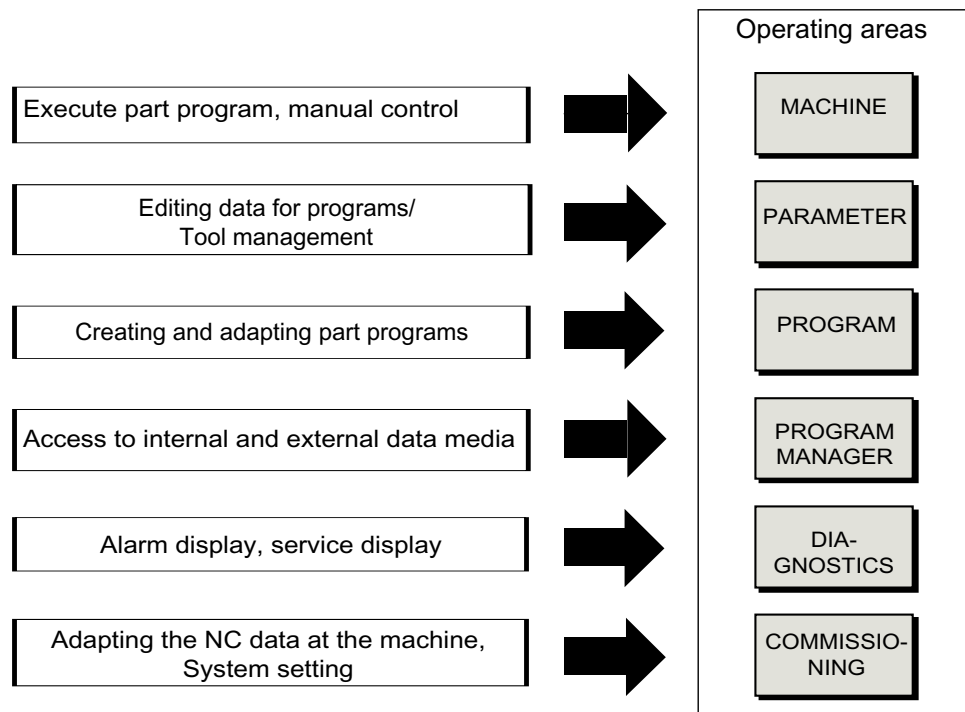

2.2 Operator panel fronts

2.2.1 Overview

Introduction

The display (screen) and operation (e.g. hardkeys and softkeys) of the SINUMERIK Operate user interface use the operator panel front.

In this example, the OP 010 operator panel front is used to illustrate the components that are available for operating the controller and machine tool.

Operator controls and indicators

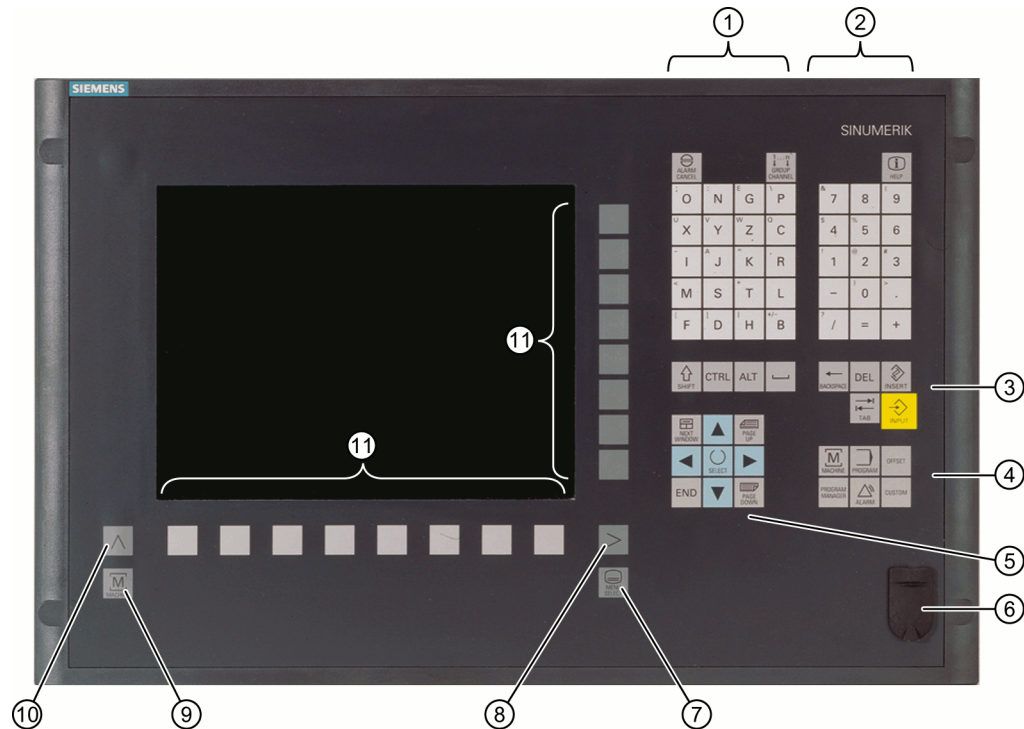

- 1 Alphabetic key group
With the <Shift> key pressed, you activate the special characters on keys with double assignments, and write in the uppercase.
Note: Depending on the particular configuration of your control system, uppercase letters are always written
- 2 Numerical key group
With the <Shift> key pressed, you activate the special characters on keys with double assignments.
- 3 Control key group
- 4 Hotkey group
- 5 Cursor key group
- 6 USB interface
- 7 Menu select key
- 8 Menu forward button
- 9 Machine area button
- 10 Menu back key
- 11 Softkeys

Figure 2-1 View of OP 010 operator panel front

References





A more precise description as well as a view of the other operator panel fronts that can be used may be found in the following reference:

Manual operator components and networking; SINUMERIK 840D sl

2.2.2 Keys of the operator panel

The following keys and key combinations are available for operation of the control and the machine tool.

Keys and key combinations

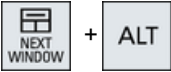
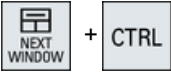
Key	Function
	<ALARM CANCEL> Cancels alarms and messages that are marked with this symbol.
	<CHANNEL> Advances for several channels.
	<HELP> Calls the context-sensitive online help for the selected window.
	<NEXT WINDOW> * <ul style="list-style-type: none"> • Toggles between the windows. • For a multi-channel view or for a multi-channel functionality, switches within a channel gap between the upper and lower window. • Selects the first entry in selection lists and in selection fields. • Moves the cursor to the beginning of a text. * on USB keyboards use the <Home> or <Pos 1> key
	<NEXT WINDOW> + <SHIFT> <ul style="list-style-type: none"> • Selects the first entry in selection lists and in selection fields. • Moves the cursor to the beginning of a text. • Selects a contiguous selection from the current cursor position up to the target position. • Selects a contiguous selection from the current cursor position up to the beginning of a program block.
	<NEXT WINDOW> + <ALT> <ul style="list-style-type: none"> • Moves the cursor to the first object. • Moves the cursor to the first column of a table row. • Moves the cursor to the beginning of a program block.
	<NEXT WINDOW> + <CTRL> <ul style="list-style-type: none"> • Moves the cursor to the beginning of a program. • Moves the cursor to the first row of the current column.

**<NEXT WINDOW> + <CTRL> + <SHIFT>**

- Moves the cursor to the beginning of a program.
- Moves the cursor to the first row of the current column.
- Selects a contiguous selection from the current cursor position up to the target position.
- Selects a contiguous selection from the current cursor position up to the beginning of the program.

**<PAGE UP>**

Scrolls upwards by one page in a window.

**<PAGE UP> + <SHIFT>**

In the program manager and in the program editor from the cursor position, selects directories or program blocks up to the beginning of the window.

**<PAGE UP> + <CTRL>**

Positions the cursor to the topmost line of a window.

**<PAGE DOWN>**

Scrolls downwards by one page in a window.

**<PAGE DOWN> + <SHIFT>**

In the program manager and in the program editor, from the cursor position, selects directories or program blocks up to the end of the window.

**<PAGE DOWN> + <CTRL>**

Positions the cursor to the lowest line of a window.

**<Cursor right>**

- Editing box
Opens a directory or program (e.g. cycle) in the editor.
- Navigation
Moves the cursor further to the right by one character.

**<Cursor right> + <CTRL>**

- Editing box
Moves the cursor further to the right by one word.
- Navigation
Moves the cursor in a table to the next cell to the right.

**<Cursor left>**

- Editing box
Closes a directory or program (e.g. cycle) in the program editor. If you have made changes, then these are accepted.
- Navigation
Moves the cursor further to the left by one character.

**<Cursor left> + <CTRL>**

- Editing box
Moves the cursor further to the left by one word.
- Navigation
Moves the cursor in a table to the next cell to the left.

**<Cursor up>**

- Editing box
Moves the cursor into the next upper field.
- Navigation
 - Moves the cursor in a table to the next cell upwards.
 - Moves the cursor upwards in a menu screen.

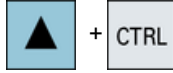
**<Cursor up> + <Ctrl>**

- Moves the cursor in a table to the beginning of the table.
- Moves the cursor to the beginning of a window.

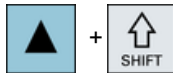
**<Cursor up> + <SHIFT>**

In the program manager and in the program editor, selects a contiguous selection of directories and program blocks.

**<Cursor down>**

- Editing box
Moves the cursor downwards.
- Navigation
 - Moves the cursor in a table to the next cell downwards.
 - Moves the cursor in a window downwards.

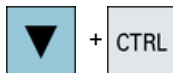
**<Cursor down> + <CTRL>**

- Navigation
 - Moves the cursor in a table to the end of the table.
 - Moves the cursor to the end of a window.
- Simulation
Reduces the override.

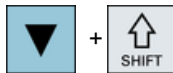
**<Cursor down> + <SHIFT>**

In the program manager and in the program editor, selects a contiguous selection of directories and program blocks.

**<SELECT>**

Switches between several specified options in selection lists and in selection boxes.

Activates checkboxes.

In the program editor and in the program manager, selects a program block or a program.

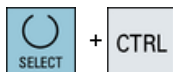
**<SELECT> + <CTRL>**

When selecting table rows, switches between selected and not selected.

**<SELECT> + <SHIFT>**

Selects in selection lists and in selection boxes the previous entry or the last entry.

**<END>**

Moves the cursor to the last entry field in a window, to the end of a table or a program block.

Selects the last entry in selection lists and in selection boxes.

**<END> + <SHIFT>**

Moves the cursor to the last entry.

Selects a contiguous selection from the cursor position up to the end of a program block.

**<END> + <CTRL>**

Moves the cursor to the last entry in the last line of the actual column or to the end of a program.

**<END> + <CTRL> + <SHIFT>**

Moves the cursor to the last entry in the last line of the actual column or to the end of a program.

Selects a contiguous selection from the cursor position up to the end of a program block.

**<BACKSPACE>**

- Editing box
Deletes a character selected to the left of the cursor.
- Navigation
Deletes all of the selected characters to the left of the cursor.

**<BACKSPACE> + <CTRL>**

- Editing box
Deletes a word selected to the left of the cursor.
- Navigation
Deletes all of the selected characters to the left of the cursor.

**<TAB>**

- In the program editor, indents the cursor by one character.
- In the program manager, moves the cursor to the next entry to the right.

**<TAB> + <SHIFT>**

- In the program editor, indents the cursor by one character.
- In the program manager, moves the cursor to the next entry to the left.

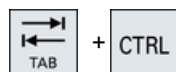
**<TAB> + <CTRL>**

- In the program editor, indents the cursor by one character.
- In the program manager, moves the cursor to the next entry to the right.

**<Tab> + <Ctrl> + <Shift>**

- In the program editor, indents the cursor by one character.
- In the program manager, moves the cursor to the next entry to the left.

**<CTRL> + <A>**

In the actual window, selects all entries (only in the program editor and program manager).

**<CTRL> + <C>**

Copies the selected content.



<CTRL> + <E>

Calls the "Ctrl Energy" function.



<CTRL> + <F>

Opens the search dialog in the machine data and setting data lists, when loading and saving in the MDI editor as well as in the program manager and in the system data.



<CTRL> + <G>

- Switches in the program editor for ShopMill or ShopTurn programs between the work plan and the graphic view.
- Switches in the parameter screen between the help display and the graphic view.



<CTRL> + <I>

Calculates the program runtime up to or from the selected set/block and displays a graphic representation of the times.



<CTRL> + <L>

Scrolls the actual user interface through all installed languages one after the other.



<CTRL> + <SHIFT> + <L>

Scrolls the actual user interface through all installed languages in the inverse sequence.



<CTRL> + <M>

Selects the maximum feedrate of 120% during the simulation.



<CTRL> + <P>

Generates a screenshot from the actual user interface and saves it as file.



<CTRL> + <S>

Switches the single block in or out in the simulation.



<CTRL> + <V>

- Pastes text from the clipboard at the actual cursor position.
- Pastes text from the clipboard at the position of a selected text.



<CTRL> + <X>

Cuts out the selected text. The text is located in the clipboard.



























<CTRL> + <Y>

Reactivates changes that were undone (only in the program editor).



<CTRL> + <Z>

Undoes the last action (only in the program editor).

	+		+		<CTRL> + <ALT> + <C> Creates a complete standard archive (.ARC) on an external data carrier (USB-FlashDrive) (for 840D sl / 828D). Note: The complete backup via this key combination is only suitable for diagnostic purposes. Note: Please refer to the machine manufacturer's specifications.
	+		+		<CTRL> + <ALT> + <S> Creates a complete standard archive (.ARC) on an external data carrier (USB-FlashDrive) (for 840D sl). Creates a complete Easy Archive (.ARD) on an external data carrier (USB-FlashDrive) (for 828D). Note: The complete backup (.ARC) via this key combination is only suitable for diagnostic purposes. Note: Please refer to the machine manufacturer's specifications.
	+		+		<CTRL> + <ALT> + <D> Backs up the log files on the USB-FlashDrive. If a USB-FlashDrive is not inserted, then the files are backed-up in the manufacturer's area of the CF card.
	+		+		<SHIFT> + <ALT> + <D> Backs up the log files on the USB-FlashDrive. If a USB-FlashDrive is not inserted, then the files are backed-up in the manufacturer's area of the CF card.
	+		+		<SHIFT> + <ALT> + <T> Starts "HMI Trace".
	+		+		<SHIFT> + <ALT> + <T> Exits "HMI Trace".
	+		<ALT> + <S> Opens the editor to enter Asian characters.		
	+		<ALT> + <Cursor up> Moves the block start or block end up in the editor.		
	+		<ALT> + <Cursor down> Moves the block start or block end down in the editor.		
					<ul style="list-style-type: none"> • Editing box Deletes the first character to the right of the cursor. • Navigation Deletes all characters.



** + <CTRL>**

- Editing box
Deletes the first word to the right of the cursor.
- Navigation
Deletes all characters.



<Spacebar>

- Editing box
Inserts a space.
- Switches between several specified options in selection lists and in selection boxes.



<Plus>

- Opens a directory which contains the element.
- Increases the size of the graphic view for simulation and traces.



<Minus>

- Closes a directory which contains the element.
- Reduces the size of the graphic view for simulation and traces.



<Equals>

Opens the calculator in the entry fields.



<Asterisk>

Opens a directory with all of the subdirectories.



<Tilde>

Changes the sign of a number between plus and minus.



<INSERT>

- Opens an editing window in the insert mode. Pressing the key again, exits the window and the entries are undone.
- Opens a selection box and shows the selection possibilities.
- In the machining step program, enters an empty line for G code.
- Changes into the double editor or into the multi-channel view from the edit mode into the operating mode. You can return to the edit mode by pressing the key again.



<INSERT> + <SHIFT>

For G code programming, for a cycle call activates or deactivates the edit mode.

**<INPUT>**

- Completes input of a value in the entry field.
- Opens a directory or a program.
- Inserts an empty program block if the cursor is positioned at the end of a program block.
- Inserts a character to select a new line and the program block is split up into two parts.
- In the G code, inserts a new line after the program block.
- In the machining step program, inserts a new line for G code e
- Changes into the double editor or into the multi-channel view from the edit mode into the operating mode. You can return to the edit mode by pressing the key again.

**<ALARM> - only OP 010 and OP 010C**

Calls the "Diagnosis" operating area.

**<PROGRAM> - only OP 010 and OP 010C**

Calls the "Program Manager" operating area.

**<OFFSET> - only OP 010 and OP 010C**

Calls the "Parameter" operating area.

**<PROGRAM MANAGER> - only OP 010 and OP 010C**

Calls the "Program Manager" operating area.

**Menu forward key**

Advances in the extended horizontal softkey bar.

**Menu back key**

Returns to the higher-level menu.

**<MACHINE>**

Calls the "Machine" operating area.

**<MENU SELECT>**

Calls the main menu to select the operating area.

2.3 Machine control panels

2.3.1 Overview

The machine tool can be equipped with a machine control panel by Siemens or with a specific machine control panel from the machine manufacturer.

You use the machine control panel to initiate actions on the machine tool such as traversing an axis or starting the machining of a workpiece.

2.3.2 Controls on the machine control panel

In this example, the MCP 483C IE machine control panel is used to illustrate the operator controls and displays of a Siemens machine control panel.

Overview

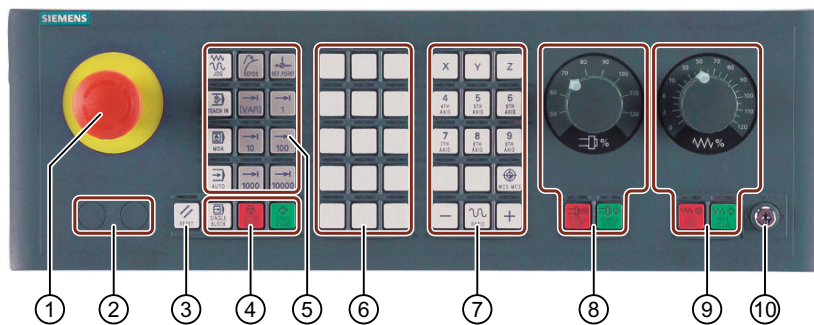

- (1) EMERGENCY STOP button
- (2) Installation locations for control devices (d = 16 mm)
- (3) RESET
- (4) Program control
- (5) Operating modes, machine functions
- (6) User keys T1 to T15
- (7) Traversing axes with rapid traverse override and coordinate switchover
- (8) Spindle control with override switch
- (9) Feed control with override switch
- (10) Keyswitch (four positions)

Figure 2-2 Front view of machine control panel (milling version)

Operator controls

EMERGENCY STOP button

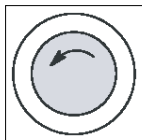

Press the button in situations where:

- life is at risk.
- there is the danger of a machine or workpiece being damaged.

All drives will be stopped with the greatest possible braking torque.



Machine manufacturer

For additional responses to pressing the EMERGENCY STOP button, please refer to the machine manufacturer's instructions.

RESET



- Stop processing the current programs.
The NCK control remains synchronized with the machine. It is in its initial state and ready for a new program run.
- Cancel alarm.

Program control



<SINGLE BLOCK>

Single block mode on/off.



<CYCLE START>

The key is also referred to as NC Start.
Execution of a program is started.



<CYCLE STOP>

The key is also referred to as NC Stop.
Execution of a program is stopped.

Operating modes, machine functions



<JOG>

Select "JOG" mode.



<TEACH IN>

Select "Teach In" submode.



<MDI>

Select "MDI" mode.



<AUTO>

Select "AUTO" mode.



<REPOS>

Repositions, re-approaches the contour.



<REF POINT>
Approach reference point.



Inc <VAR>(Incremental Feed Variable)
Incremental mode with variable increment size.



Inc (incremental feed)
Incremental mode with predefined increment size of 1, ..., 10000 increments.

...



Machine manufacturer
A machine data code defines how the increment value is interpreted.

Traversing axes with rapid traverse override and coordinate switchover



Axis keys
Selects an axis.

...



Direction keys
Select the traversing direction.

...



<RAPID>
Traverse axis in rapid traverse while pressing the direction key.



<WCS MCS>
Switches between the workpiece coordinate system (WCS) and machine coordinate system (MCS).

Spindle control with override switch



<SPINDLE STOP>
Stop spindle.



<SPINDLE START>
Spindle is enabled.

Feed control with override switch**<FEED STOP>**

Stops execution of the running program and shuts down axis drives.

**<FEED START>**

Enable for program execution in the current block and enable for ramp-up to the feedrate value specified by the program.

2.4 User interface

2.4.1 Screen layout

Overview

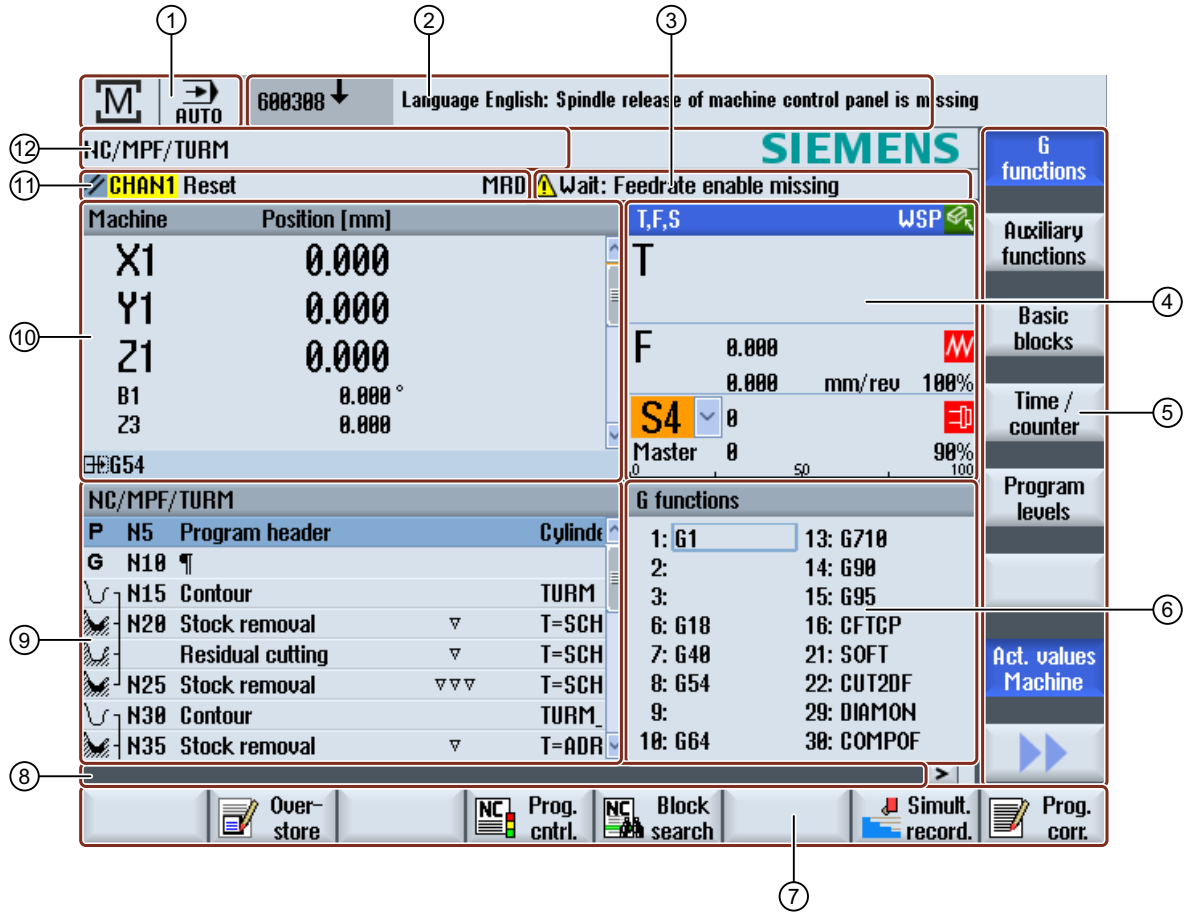

- 1 Active operating area and mode
- 2 Alarm/message line
- 3 Channel operational messages
- 4 Display for
 - active tool T
 - current feedrate F
 - active spindle with current status (S)
 - Spindle utilization rate in percent
- 5 Vertical softkey bar
- 6 Display of active G functions, all G functions, H functions and input window for different functions (for example, skip blocks, program control)
- 7 Horizontal softkey bar

- 8 Dialog line to provide additional user notes
- 9 Operating window with program block display
- 10 Axis position display in the actual value window
- 11 Channel state and program control
- 12 Program name

Figure 2-3 User interface

2.4.2 Status display

The status display includes the most important information about the current machine status and the status of the NCK. It also shows alarms as well as NC and PLC messages.



Depending on your operating area, the status display is made up of several lines:

- Large status display
The status display is made up of three lines in the "Machine" operating area.
- Small status display
In the "Parameter", "Program", "Program Manager", "Diagnosis" and "Start-up" operating areas, the status display consists of the first line from the large display.



Status display of "Machine" operating area



First line

Ctrl-Energy - Power rating display







Display	Description
	The machine is not productive.
	The machine is productive and energy is being consumed.
	The machine is feeding energy back into the grid.
<p>The power rating display must be switched on in the status line.</p> <p>Note</p> <p>Information about configuration is available in the following reference: System Manual "Ctrl-Energy", SINUMERIK 840D sl / 828D</p>	

Active operating area



Display	Description
	"Machine" operating area With touch operation, you can change the operating area here.
	"Parameter" operating area
	"Program" operating area

Display	Description
	"Program manager" operating area
	"Diagnosis" operating area
	"Start-up" operating area

Active mode or submode

Display	Description
	"Jog" mode
	"MDA" mode
	"Auto" mode
	"Teach In" submode
	"Repos" submode
	"Ref Point" submode

Alarms and messages

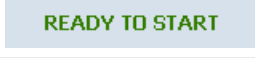
Display	Description
	Alarm display The alarm numbers are displayed in white lettering on a red background. The associated alarm text is shown in red lettering. An arrow indicates that several alarms are active. An acknowledgment symbol indicates that the alarm can be acknowledged or canceled.
	NC or PLC message Message numbers and texts are shown in black lettering. An arrow indicates that several messages are active.
	Messages from NC programs do not have numbers and appear in green lettering.

Second line

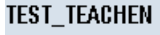
Display	Description
	Program path and program name





The displays in the second line can be configured.



Machine manufacturer

Please refer to the machine manufacturer's specifications.

Third line

Display	Description
	Display of channel status. If several channels are present on the machine, the channel name is also displayed. If only one channel is available, only the "Reset" channel status is displayed. With touch operation, you can change the channel here.
	Display of channel status: The program was aborted with "Reset". The program is started. The program has been interrupted with "Stop".
	Display of active program controls: PRT: no axis motion DRY: Dry run feedrate RG0: reduced rapid traverse M01: programmed stop 1 M101: programmed stop 2 (name varies) SB1: Single block, coarse (program stops only after blocks which perform a machine function) SB2: Data block (program stops after each block) SB3: Single block, fine (program also only stops after blocks which perform a machine function in cycles)
	Channel operational messages: Stop: An operator action is usually required. Wait: No operator action is required.

The machine manufacturer settings determine which program controls are displayed.

**Machine manufacturer**

Please refer to the machine manufacturer's specifications.

2.4.3 Actual value window

The actual values of the axes and their positions are displayed.

Work/Machine

The displayed coordinates are based on either the machine coordinate system or the workpiece coordinate system. The machine coordinate system (Machine), in contrast to the workpiece coordinate system (Work), does not take any work offsets into consideration.

You can use the "Machine actual values" softkey to toggle between the machine coordinate system and the workpiece coordinate system.

The actual value display of the positions can also refer to the SZS coordinate system (settable zero system). However the positions are still output in the Work.

The SZS coordinate system corresponds to the Work coordinate system, reduced by certain components (\$P_TRAFRAME, \$P_PFRAME, \$P_ISO4FRAME, \$P_CYCFRAME), which are set by the system when machining and are then reset again. By using the SZS coordinate system, jumps into the actual value display are avoided that would otherwise be caused by the additional components.



Machine manufacturer

Please refer to the machine manufacturer's specifications.



Maximize display

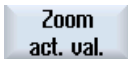

Press the ">>" and "Zoom act. val." softkeys.



Display overview

Display	Meaning	
Header columns		
Work/Machine	Display of axes in selected coordinate system.	
Position	Position of displayed axes.	
Display of distance-to-go	The distance-to-go for the current NC block is displayed while the program is running.	
Feed/override	The feed acting on the axes, as well as the override, are displayed in the full-screen version.	
Repos offset	The distances traversed in manual mode are displayed. This information is only displayed when you are in the "Repos" sub-mode.	
Collision monitoring (only 840D sl)		Collision avoidance is activated for the JOG and MDA or AUTOMATIC modes. Note: The \$MN_JOG_MODE_MASK machine data can be set to suppress the display of the symbol. Please refer to the machine manufacturer's specifications.
		Collision avoidance is deactivated for the JOG and MDA or AUTOMATIC modes.
Footer	Display of active work offsets and transformations. The T, F, S values are also displayed in the full-screen version.	



See also

Zero offsets (Page 112)

2.4.4 T,F,S window

The most important data concerning the current tool, the feedrate (path feed or axis feed in JOG) and the spindle is displayed in the T, F, S window.

In addition to the "T, F, S" window name, the following information is also displayed:

Display	Meaning
BC (example)	Name of the tool carrier
Turning (example)	Name of the active kinematic transformation
	Active tool carrier rotated in the plane
	Active tool carrier swiveled in space

Tool data





Display	Meaning
T	
Tool name	Name of the current tool
Location	Location number of the current tool
D	Cutting edge of the current tool The tool is displayed with the associated tool type symbol corresponding to the actual coordinate system in the selected cutting edge position. If the tool is swiveled, then this is taken into account in the display of the cutting edge position. In DIN-ISO mode the H number is displayed instead of the cutting edge number.
H	H number (tool offset data record for DIN-ISO mode) If there is a valid D number, this is also displayed.
∅	Diameter of the current tool
R	Radius of the current tool
L	Length of the actual tool
Z	Z value of the current tool
X	X value of the current tool

Feed data

Display	Meaning
F	
	Feed disable

Display	Meaning
	Actual feed value If several axes traverse, is displayed for: <ul style="list-style-type: none"> • "JOG" mode: Axis feed for the traversing axis • "MDA" and "AUTO" mode: Programmed axis feed
Rapid traverse	G0 is active
0.000	No feed is active
Override	Display as a percentage

Spindle data

Display	Meaning
S	
S1	Spindle selection, identification with spindle number and main spindle
Speed	Actual value (when spindle turns, display increases) Setpoint (always displayed, also during positioning)
Symbol	Spindle status  Spindle not enabled  Spindle is turning clockwise  Spindle is turning counterclockwise  Spindle is stationary
Override	Display as a percentage
Spindle utilization rate	Display between 0 and 100% The upper limit value can be greater than 100%. See machine manufacturer's specifications.

Note

Display of logical spindles

If the spindle converter is active, logical spindles are displayed in the workpiece coordinate system. When switching over to the machine coordinate system, the physical spindles are displayed.



Machine manufacturer

Please refer to the machine manufacturer's specifications.

2.4.5 Current block display

The window of the current block display shows the program blocks currently being executed.

Display of current program

The following information is displayed in the running program:

- The workpiece name or program name is entered in the header line.
- The program block which is just being processed appears colored.

Display of the machining times

If you set that the machining times are to be recorded in the settings for automatic mode, the measured times are shown at the end of the line as follows:

Display	Meaning
Light green background ☉ 17.18	Measured machining time of the program block (automatic mode)
Green background ☉ 19.47	Measured machining time of the program block (automatic mode)
Light blue background ☉ 17.31	Estimated machining time of the program block (simulation)
Blue background ☉ 19.57	Estimated machining time of the program block (simulation)
Yellow background ☉ 4.53	Wait time (automatic mode or simulation)

Highlighting of selected G code commands or keywords

In the program editor settings, you can specify whether selected G code commands are to be highlighted in color. The following colors are used as standard:

Display	Meaning
Blue font M30¶	D, S, F, T, M and H functions
Red font G0¶	"G0" motion command
Green font G1¶	"G1" motion command
Blue-green font G3¶	"G2" or "G3" motion command
Gray font ; Kommentar¶	Comment

Machine manufacturer



You can define further highlight colors in the "sleditorwidget.ini" configuration file. Please refer to the machine manufacturer's instructions.

Editing a program directly

In the Reset state, you can edit the current program directly.



1. Press the <INSERT> key.
2. Place the cursor at the relevant position and edit the program block. Direct editing is only possible for G code blocks in the NC memory, not for external execution.



3. Press the <INSERT> key to exit the program and the edit mode again.

See also

Setting for automatic mode (Page 227)

2.4.6 Operation via softkeys and buttons

Operating areas/operating modes

The user interface consists of different windows featuring eight horizontal and eight vertical softkeys.

You operate the softkeys with the keys next to the softkey bars.

You can display a new window or execute functions using the softkeys.

The operating software is sub-divided into six operating areas (machine, parameter, program, program manager, diagnosis, startup) and five operating modes or submodes (JOG, MDA, AUTO, TEACH IN, REF POINT, REPOS).

Changing the operating area



Press the <MENU SELECT> key and select the desired operating area using the horizontal softkey bar.

You can call the "Machine" operating area directly using the key on the operator panel.



Press the <MACHINE> key to select the "machine" operating area.

Changing the operating mode

You can select a mode or submode directly using the keys on the machine control panel or using the vertical softkeys in the main menu.

General keys and softkeys



When the  symbol appears to the right of the dialog line on the user interface, you can change the horizontal softkey bar within an operating area. To do so, press the menu forward key.

The  symbol indicates that you are in the expanded softkey bar.

Pressing the key again will take you back to the original horizontal softkey bar.

Use the ">>" softkey to open a new vertical softkey bar.



Use the "<<" softkey to return to the previous vertical softkey bar.



Use the "Return" softkey to close an open window.



Use the "Cancel" softkey to exit a window without accepting the entered values and return to the next highest window.



When you have entered all the necessary parameters in the parameter screen form correctly, you can close the window and save the parameters using the "Accept" softkey. The values you entered are applied to a program.



Use the "OK" softkey to initiate an action immediately, e.g. to rename or delete a program.

2.4.7 Entering or selecting parameters

When setting up the machine and during programming, you must enter various parameter values in the entry fields. The background color of the fields provides information on the status of the entry field.

Orange background	The input field is selected
Light orange background	The input field is in edit mode
Pink background	The entered value is incorrect

Selecting parameters

Some parameters require you to select from a number of options in the input field. Fields of this type do not allow you to type in a value.

The selection symbol is displayed in the tooltip: 

Associated selection fields

There are selection fields for various parameters:

- Selection of units
- Changeover between absolute and incremental dimensions

Procedure



1. Keep pressing the <SELECT> key until the required setting or unit is selected.

The <SELECT> key only works if there are several selection options available.

- OR -



Press the <INSERT> key.

The selection options are displayed in a list.



2. Select the required setting using the <Cursor down> and <Cursor up> keys.



3. If required, enter a value in the associated input field.



4. Press the <INPUT> key to complete the parameter input.

Changing or calculating parameters

If you only want to change individual characters in an input field rather than overwriting the entire entry, switch to insertion mode.

In this mode, you can also enter simple calculation expressions, without having to explicitly call the calculator.

Note

Functions of the calculator

Function calls of the calculator are not available in the parameter screens of the cycles and functions in the "Program" operating area.



Press the <INSERT> key.

The insert mode is activated.



You can navigate within the input field using the <Cursor left> and <Cursor right> keys.





Use the <BACKSPACE> and key to delete individual characters.



Enter the value or the calculation.

Close the value entry using the <INPUT> key and the result is transferred into the field.

Accepting parameters

When you have correctly entered all necessary parameters, you can close the window and save your settings.

You cannot accept the parameters if they are incomplete or obviously erroneous. In this case, you can see from the dialog line which parameters are missing or were entered incorrectly.



Press the "OK" softkey.

- OR -



Press the "Accept" softkey.

2.4.8 Pocket calculator

The calculator allows you to calculate values for entry fields. It is possible to choose between a simple standard calculator and the extended view with mathematical functions.

Using the calculator

- You can simply use the calculator at the touch panel.
- Without a touch panel, you can use the calculator using the mouse.

Procedure



1. Position the cursor on the desired entry field.

2. Press the <=> key.

The calculator is displayed.



3. Press the <min> key if you would like to work with the standard calculator.





- OR -



Press the <extend> key to switch to the extended view.

4. Input the arithmetic statement.







You can use functions, arithmetic symbols, numbers, and commas.

- 
- 5. Press the equals symbol on the calculator.
- OR -
- 
- Press the "Calculate" softkey.
- OR -
- 
- Press the <INPUT> key.
- The new value is calculated and displayed in the entry field of the calculator.
- 
- 6. Press the "Accept" softkey.
- The calculated value is accepted and displayed in the entry field of the window.

2.4.9 Pocket calculator functions

The called operations continue to be displayed in the entry field of the calculator until the value is calculated. This allows you to subsequently modify entries and to nest functions.

The following save and delete functions are provided for modifications:

Key	Function
	Buffer value (Memory Save)
	Retrieve from buffer memory (Memory Recall)
	Delete buffer memory contents (Memory Clear)
	Delete individual character (Backspace)
	Delete expression (Clear Element)
	Delete all entries (Clear)

Nesting functions

Various possibilities are available for the nesting of functions as follows:

- Position the cursor within the bracket of the function call and supplement the argument with an additional function.
- Highlight the expression which is to be used as an argument in the entry line and then press the desired function key.

Percentage calculation

The calculator supports the calculation of a percentage, as well as changing of a basic value by a percentage. Press the following keys in this regard:





Example: Percentage

4  50   2

Example: Change by percentage

4  50   6

Calculating trigonometric functions

1. Check whether the angles are specified in radians "RAD" or in degrees "DEG".

 2. Press the "RAD" key to calculate the trigonometric functions in degrees "DEG".
The designation of the key changes to "DEG".
- OR -
Press the "DEG" key to calculate the trigonometric functions in radian.
The designation of the key changes to "RAD".

 3. Press the key for the desired trigonometric function, e.g. "SIN".

 4. Enter the numerical value.
- ...
- 

Further mathematical functions

Press the keys in the specified order:

Square number

 Number

Square root

 Number

Exponential function

Base number  Exponent

Residue class calculation

Number  Divider

Absolute value

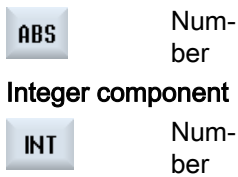

Conversion between millimeters and inches

The image shows three buttons: 'MM', 'INCH', and '='.

1. Enter the numerical value.
2. Press the "MM" key to convert inches to millimeters. The key is highlighted in blue.
- OR -
Press the "INCH" key to convert millimeters to inches. The button is highlighted in blue.
3. Press the "=" key on the calculator. The calculated value is displayed in the entry field. The key for the unit is highlighted in gray once again.

2.4.10 Context menu

When you right-click, the context menu opens and provides the following functions:

- Cut
Cut Ctrl+X
- Copy
Copy Ctrl+C
- Paste
Paste Ctrl+V

Program editor

Additional functions are available in the editor

- Undo the last change
Undo Ctrl+Z
- Redo the changes that were undone
Redo Ctrl+Y

Up to 50 changes can be undone.

2.4.11 Changing the user interface language

Procedure

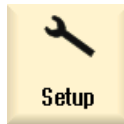

1. Select the "Start-up" operating area.



2. Press the "Change language" softkey.

The "Language selection" window opens. The language set last is selected.



3. Position the cursor on the desired language.

4. Press the "OK" softkey.

- OR -

Press the <INPUT> key.



The user interface changes to the selected language.

Note

Changing the language directly on the input screens

You can switch between the user interface languages available on the controller directly on the user interface by pressing the key combination <CTRL + L>.

2.4.12 Entering Chinese characters

2.4.12.1 Function - input editor

Using the input editor IME (Input Method Editor), you can select Asian characters on classic panels (without touch operation) where you enter the phonetic notation. These characters are transferred into the user interface.

Note

Call the input editor with <Alt + S>

The input editor can only be called there where it is permissible to enter Asian characters.

The editor is available for the following Asian languages:

- Simplified Chinese
- Traditional Chinese

Input types

Input type	Description
Pinyin input	Latin letters are combined phonetically to denote the sound of the character. The editor lists all of the characters from the dictionary that can be selected.
Zhuyin input (only traditional Chinese)	Non-Latin letters are combined phonetically to denote the sound of the character. The editor lists all of the characters from the dictionary that can be selected.
Entering Latin letters	The characters that are entered are directly transferred into the input field, from where the editor was called.

Structure of the editor

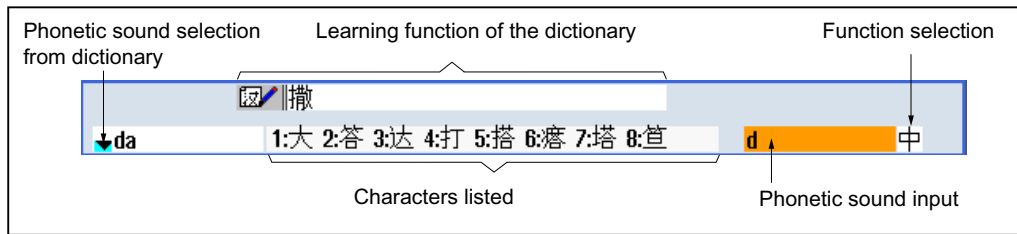

Figure 2-4 Example: Pinyin input

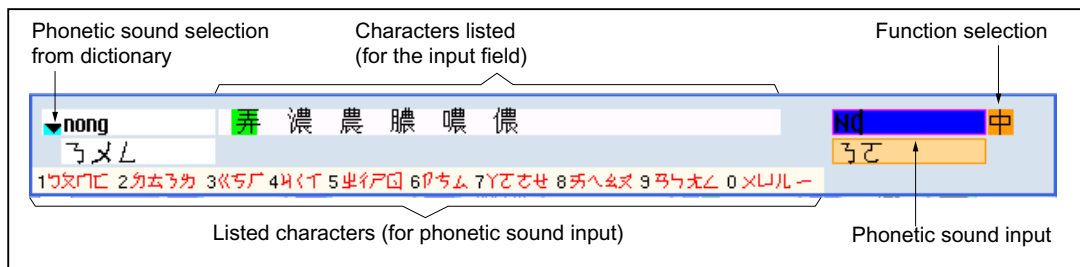

Figure 2-5 Example: Zhuyin input

Functions

- 中 Pinyin input
- A Entering Latin letters
- Editing the dictionary

Dictionaries

The simplified Chinese and traditional Chinese dictionaries that are supplied can be expanded:

- If you enter new phonetic notations, the editor creates a new line. The entered phonetic notation is broken down into known phonetic notations. Select the associated character for each component. The compiled characters are displayed in the additional line. Accept the new word into the dictionary and into the input field by pressing the <Input> key.
- Using any Unicode editor, you can enter new phonetic notations into a text file. These phonetic notations are imported into the dictionary the next time that the input editor is started.

2.4.12.2 Entering Asian characters

Precondition

The control has been switched over to Chinese.

Procedure

Editing characters using the Pinyin method



+



1. Open the screen form and position the cursor on the input field. Press the <Alt +S> keys. The editor is displayed.
2. Enter the desired phonetic notation using Latin letters. Use the upper input field for traditional Chinese.
3. Press the <Cursor down> key to reach the dictionary.
4. Keeping the <Cursor down> key pressed, displays all the entered phonetic notations and the associated selection characters.
5. Press the <BACKSPACE> softkey to delete entered phonetic notations.
6. Press the number key to insert the associated character. When a character is selected, the editor records the frequency with which it is selected for a specific phonetic notation and offers this character at the top of the list when the editor is next opened.

Editing characters using the Zhuyin method (only traditional Chinese)



+



1. Open the screen form and position the cursor on the input field.
Press the <Alt +S> keys.
The editor is displayed.
2. Enter the desired phonetic notation using the numerical block.
Each number is assigned a certain number of letters that can be selected by pressing the numeric key one or several times.
3. Press the <Cursor down> key to reach the dictionary.
4. Keeping the <Cursor down> key pressed, displays all the entered phonetic notations and the associated selection characters.
5. Press the <BACKSPACE> softkey to delete entered phonetic notations.
6. To select the associated character, press the <cursor right> or <cursor left> keys.
7. Press the <input> key to enter the character.

2.4.12.3 Editing the dictionary

Learning function of the input editor

Requirement:

The control has been switched over to Chinese.

An unknown phonetic notation has been entered into the input editor.

1. The editor provides a further line in which the combined characters and phonetic notations are displayed.
The first part of the phonetic notation is displayed in the field for selecting the phonetic notation from the dictionary. Various characters are listed for this particular phonetic notation.
2. Press the number key to insert the associated character into the additional line.
The next part of the phonetic notation is displayed in the field for selecting the phonetic notation from the dictionary.
3. Repeat step 2 until the complete phonetic notation has been compiled.



Press the <TAB> key to toggle between the compiled phonetic notation field and the phonetic notation input.

Compiled characters are deleted using the <BACKSPACE> key.



4. Press the <input> key to transfer the compiled phonetic notation to the dictionary and the input field.

Importing a dictionary

A dictionary can now be generated using any Unicode editor by attaching the corresponding Chinese characters to the pinyin phonetic spelling. If the phonetic spelling contains several Chinese characters, then the line must not contain any additional match. If there are several matches for one phonetic spelling, then these must be specified in the dictionary line by line. Otherwise, several characters can be specified for each line.

The generated file should be saved in the UTF8 format under the name dictchs.txt (simplified Chinese) or dictcht.txt (traditional Chinese).

Line structure:

Pinyin phonetic spelling <TAB> Chinese characters <LF>

OR

Pinyin phonetic spelling <TAB> Chinese character1<TAB> Chinese character2 <TAB> ...
<LF>

<TAB> - tab key

<LF> - line break

Store the created dictionary in one of the following paths:

../user/sinumerik/hmi/ime/

../oem/sinumerik/hmi/ime/

When the Chinese editor is called the next time, it enters the content of the dictionary into the system dictionary.

Example:

ai	哎 哀 唉 埃 挨
caise	彩色
hongse	紅色
huise	灰色
heli	河褰
zuihaowan	最好玩

2.4.13 Entering Korean characters

You can enter Korean characters in the input fields on classic panels (without touch operation) using the input editor IME (Input Method Editor).

Note

You require a special keyboard to enter Korean characters. If this is not available, then you can enter the characters using a matrix.

Korean keyboard

To enter Korean characters, you will need a keyboard with the keyboard assignment shown below. In terms of key layout, this keyboard is the equivalent of an English QWERTY keyboard and individual events must be grouped together to form syllables.

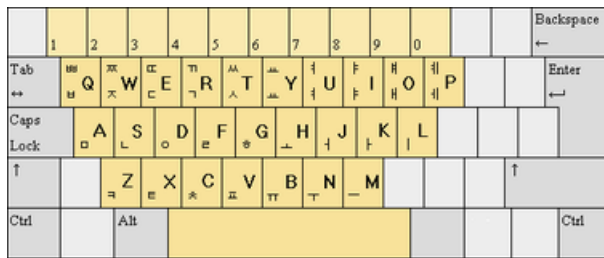

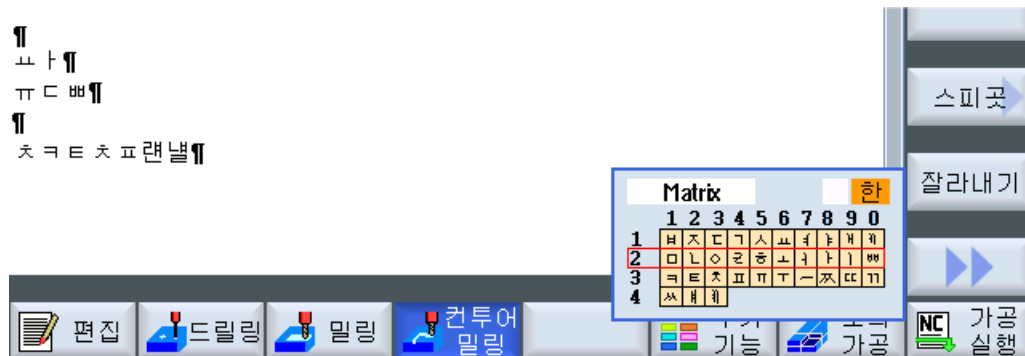

Structure of the editor



Functions

- Matrix** Editing characters using a matrix
- Beolsik 2** Editing characters using the keyboard

-  Entering Korean characters
-  Entering Latin letters

Precondition

The control has been switched over to Korean.

Procedure

Editing characters using the keyboard



+



1. Open the screen form and position the cursor on the input field.
Press the <Alt +S> keys.
The editor is displayed.

2. Switch to the "Keyboard - Matrix" selection box.

3. Select the keyboard.

4. Switch to the function selection box.

5. Select Korean character input.

6. Enter the required characters.

7. Press the <input> key to enter the character into the input field.

Editing characters using a matrix



+



1. Open the screen form and position the cursor on the input field.
Press the <Alt +S> keys.
The editor is displayed.

2. Switch to the "Keyboard - Matrix" selection box.

3. Select the "matrix".

4. Switch to the function selection box.



5. Select Korean character input.
6. Enter the number of the line in which the required character is located. The line is highlighted in color.
7. Enter the number of the column in which the required character is located. The character will be briefly highlighted in color and then transferred to the Character field.



Press the <BACKSPACE> softkey to delete entered phonetic notations.



8. Press the <input> key to enter the character into the input field.

2.4.14 Protection levels

The input and modification of data in the control system is protected by passwords at sensitive places.

Access protection via protection levels

The input or modification of data for the following functions depends on the protection level setting:

- Tool offsets
- Work offsets
- Setting data
- Program creation / program editing

Note

Configuring access levels for softkeys

You have the option of providing softkeys with protection levels or completely hiding them.

References







For additional information, please refer to the following documentation:



SINUMERIK Operate Commissioning Manual

Softkeys

Machine operating area	Protection level
 SYNC Synchronisation action.	End user (protection level 3)

Parameters operating area	Protection level
Tool management lists 	Keyswitch 3 (protection level 4)

Diagnostics operating area	Protection level
	Keyswitch 3 (protection level 4)
	User (protection level 3)
	User (protection level 3)
	Manufacturer (protection level 1)
	User (protection level 3)
	Service (protection level 2)

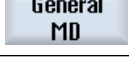
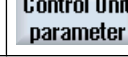
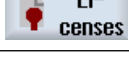
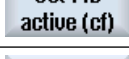
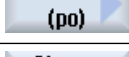
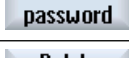
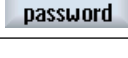
Start-up operating area	Protection levels
	End user (protection level 3)
	Keyswitch 3 (protection level 4)
 	Keyswitch 3 (protection level 4)
	Keyswitch 3 (protection level 4)
	Keyswitch 3 (protection level 4)
	End user (protection level 3)
	End user (protection level 3)
	End user (protection level 3)

2.4.15 Online help in SINUMERIK Operate

A comprehensive context-sensitive online help is stored in the control system.

- A brief description is provided for each window and, if required, step-by-step instructions for the operating sequences.
- A detailed help is provided in the editor for every entered G code. You can also display all G functions and take over a selected command directly from the help into the editor.
- A help page with all parameters is provided on the input screen in the cycle programming.
- Lists of the machine data
- Lists of the setting data
- Lists of the drive parameters
- List of all alarms

Procedure

Calling context-sensitive online help



1. You are in an arbitrary window of an operating area.
2. Press the <HELP> key or on an MF2 keyboard, the <F12> key.
The help page of the currently selected window is opened in a subscreen.



3. Press the "Full screen" softkey to use the entire user interface for the display of the online help.



Press the "Full screen" softkey again to return to the subscreen.



4. If further help is offered for the function or associated topics, position the cursor on the desired link and press the "Follow reference" softkey.
The selected help page is displayed.

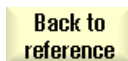

5. Press the "Back to reference" softkey to jump back to the previous help.

Calling a topic in the table of contents

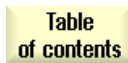

1. Press the "Table of contents" softkey.
Depending on which technology you are using, the Operating Manuals "Operator control Milling", "Operator control Turning" or "Operator control Universal" as well as the "Programming" Programming Manual are displayed.



2. Select the desired manual with the <Cursor down> and <Cursor up> keys.





3. Press the <Cursor right> or <INPUT> key or double-click to open the book and the section.



4. Navigate to the desired topic with the "Cursor down" key.



5. Press the <Follow reference> softkey or the <INPUT> key to display the help page for the selected topic.



6. Press the "Current topic" softkey to return to the original help.

Searching for a topic



1. Press the "Search" softkey.
The "Search in Help for: " window appears.

2. Activate the "Full text " checkbox to search in all help pages.
If the checkbox is not activated, a search is performed in the table of contents and in the index.



3. Enter the desired keyword in the "Text" field and press the "OK" softkey.
If you enter the search term on the operator panel, replace an umlaut (accented character) by an asterisk (*) as dummy.

All entered terms and sentences are sought with an AND operation. In this way, only documents and entries that satisfy all the search criteria are displayed.

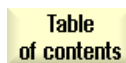

4. Press the "Keyword index" softkey if you only want to display the index of the operating and programming manual.

Displaying alarm descriptions and machine data



1. If messages or alarms are pending in the "Alarms", "Messages" or "Alarm Log" window, position the cursor at the appropriate display and press <HELP> or key <F12>

The associated alarm description is displayed.



2. If you are in the "Start-up" operating area in the windows for the display of the machine, setting and drive data, position the cursor on the desired machine data or drive parameter and press the <HELP> key or <F12> key.





The associated data description is displayed.

Displaying and inserting a G code command in the editor



1. A program is opened in the editor.
Position the cursor on the desired G code command and press the <HELP> or the <F12> key.

The associated G code description is displayed.

- | | |
|---|---|
|  | 2. Press the "Display all G functions" softkey. |
|  | 3. With the aid of the search function, select, for example, the desired G code command. |
|  | 4. Press the "Transfer to editor" softkey.
The selected G function is taken into the program at the cursor position. |
|  | 5. Press the "Exit help" softkey again to close the help. |

Multitouch operation with SINUMERIK Operate

3.1 Multitouch panels

The "SINUMERIK Operate Generation 2" user interface has been optimized for multitouch operation. You can execute all actions by touch and finger gestures. Using SINUMERIK Operate is much quicker with touch operation and finger gestures.



Machine manufacturer

Please observe the information provided by the machine manufacturer.

The following SINUMERIK operator panel fronts and SINUMERIK controllers can be operated with the "SINUMERIK Operate Generation 2" user interface:

- OP 015 black
- OP 019 black
- PPU 290.3

Literature

Further information on the subject of "user interface" is available in the following literature:

- SINUMERIK Operate Commissioning Manual (IM9), 840D sl
- SINUMERIK Operate Commissioning Manual (IH9), 828D

Further information on multitouch panels is available in the following literature:

- OP 015 black / 019 black: Operator Components and Networking Manual, SINUMERIK 840D sl
- PPU 290.3: PPU and Components Manual, SINUMERIK 828D

3.2 Touch-sensitive user interface

When using touch panels, wear thin gloves made of cotton or gloves for touch-sensitive glass user interfaces with capacitive touch function.

If you are using somewhat thicker gloves, then exert somewhat more pressure when using the touch panel.

Compatible gloves

You will operate the touch-sensitive glass user interface on the Operator panel optimally with the following gloves.

- Dermatril L
- Camatril Velours type 730
- Uvex Profas Profi ENB 20A
- Camapur Comfort Antistatic type 625
- Carex type 1505 / k (leather)
- Reusable gloves, medium, white, cotton: BM Polyco (RS order number 562-952)

Thicker work gloves

- Thermoplus KCL type 955
- KCL Men at Work type 301
- Camapur Comfort type 619
- Comasec PU (4342)

3.3 Finger gestures

Finger gestures



Tap

- Select window
- Select object (e.g. NC set)
- Activate entry field
 - Enter or overwrite value
 - Tap again to change the value



Tap with 2 fingers

- Call the shortcut menu (e.g. copy, paste)



Flick vertically with one finger

- Scroll in lists (e.g. programs, tools, zero points)
- Scroll in files (e.g. NC program)



Flick vertically with two fingers

- Page-scroll in lists (e.g. ZO)
- Page-scroll in files (e.g. NC programs)



Flick vertically with three fingers

- Scroll to the start or end of lists
- Scroll to the start or end of files

3.3 Finger gestures



Flick horizontally with one finger

- Scroll in lists with many columns



Spread

- Zoom in on graphic contents (e.g. simulation, mold making view)



Pinch

- Zoom out from graphic contents (e.g. simulation, mold making view)



Pan with one finger

- Move graphic contents (e.g. simulation, mold making view)
- Move list contents



Pan with two fingers

- Rotate graphic contents (e.g. simulation, mold making view)



Tap and hold

- Open input fields to change
- Activate or deactivate edit mode (e.g. current block display)



Tap and hold using 2 fingers

- Open cycles line by line to change (without input screen form)

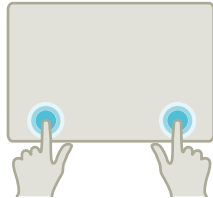

Tapping with 2 index fingers – only for 840D sl

- Tap with two fingers simultaneously in the lower right- and left-hand corners to open the TCU menu.
The menu has to be opened for service purposes.

Note

Flicking gestures with several fingers

The gestures only function reliably if you hold your fingers sufficiently far apart. The fingers should be at least 1 cm apart.

3.4 Multitouch user interface



3.4.1 Screen layout

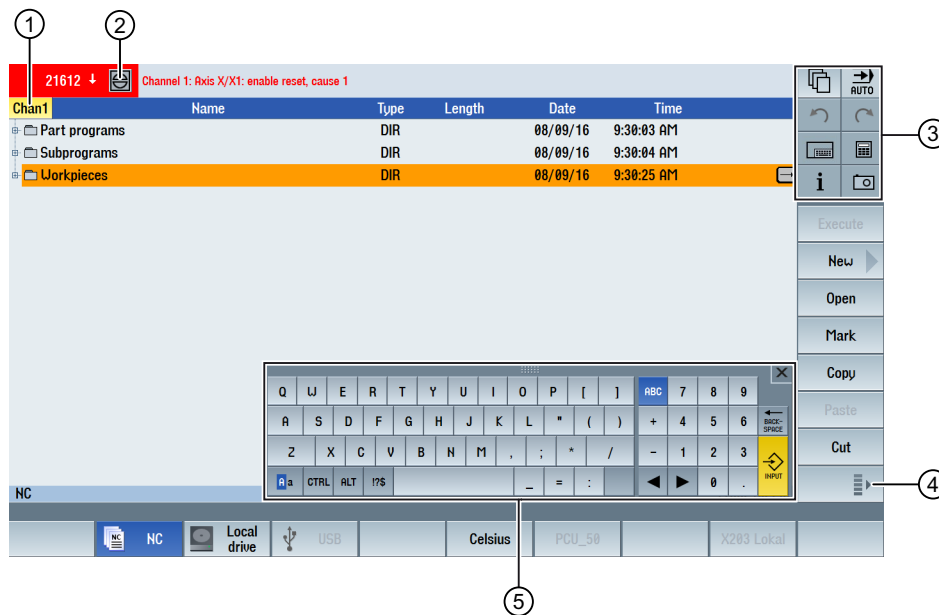





Touch and gesture operator controls for SINUMERIK Operate with the "SINUMERIK Operate Generation 2" user interface.







- ① Changing the channel
- ② Cancel alarms
- ③ Function key block
- ④ Display next vertical softkey bar
- ⑤ Virtual keyboard

3.4.2 Function key block

Operator control	Function
	Switch operating area Tap the current operating area, and select the desired operating area from the operating area bar.
	Switch operating mode The operating mode is only displayed. To switch the operating mode, tap the operating area and select the operating area from the vertical softkey bar.

Operator control	Function
	Undo Multiple changes are undone one by one. As soon as a change has been completed in an input field, this function is no longer available.
	Restoring Multiple changes are restored one by one. As soon as a change has been completed in an input field, this function is no longer available.
	Virtual keyboard Activates the virtual keyboard.
	Calculator Displays a calculator.
	Online help Opens the online help.
	Camera Generates a screenshot.

3.4.3 Further operator touch controls

Operator control	Function
	Advances to the next horizontal softkey bar. When page 2 of the menu is called, the arrow appears on the right.
	Advances to the higher-level menu.
	Advances to the next vertical softkey bar.
	Tapping the Cancel alarm symbol clears all queued cancel alarms.
	If a channel menu has been configured, it is displayed. Tapping the channel display in the status display switches you to the next channel.

3.4.4 Virtual keyboard

If you called the virtual keyboard using the function key block, then you have the option of adapting the key assignment using the shift keys.

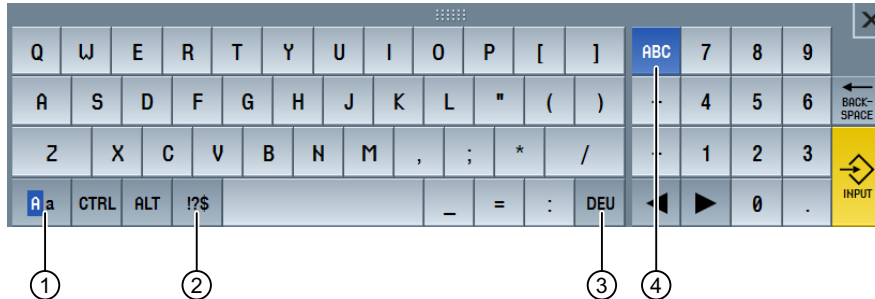

- ① Shift key for uppercase and lowercase letters
- ② Shift key for letters and special characters
- ③ Shift key for country-specific keyboard assignment
- ④ Shift key for full keyboard and numerical key block

Hardware keyboard

If a real keyboard is connected, the icon of a minimized keyboard appears in place of the virtual keyboard.



Use the icon to open the virtual keyboard again.

3.4.5 Special "tilde" character

If the shift key for letters and special characters is pressed, the keyboard assignment changes to the special characters.



- ① <Tilde>

In the Editor or in alphanumeric input fields, the special character <Tilde> is entered with the <Tilde> key. In numerical input fields, the <Tilde> key changes the sign of a number between plus and minus.

3.5 Expansion with side screen

3.5.1 Overview

Panels in widescreen format provide the possibility of using the extra area to display additional elements. In addition to the SINUMERIK Operate screen, displays and virtual keys are shown to provide faster information and operation.

This sidescreen must be activated. To do this, a navigation bar is displayed.

You can display the following elements above the navigation bar:

- Displaying (widgets)
- Virtual keys (pages)
 - ABC keyboard
 - MCP keys



Machine manufacturer

Please observe the information provided by the machine manufacturer.

Requirements

- A widescreen format multitouch panel (e.g. OP 015 black) is required to display widgets and pages.
- It is only possible to activate and configure a sidescreen when using the "SINUMERIK Operate Generation 2" user interface.

References

For information on activating the sidescreen and to configure the virtual keys, refer to the following literature:

- SINUMERIK Operate (IM9) / SINUMERIK 840D sl Commissioning Manual







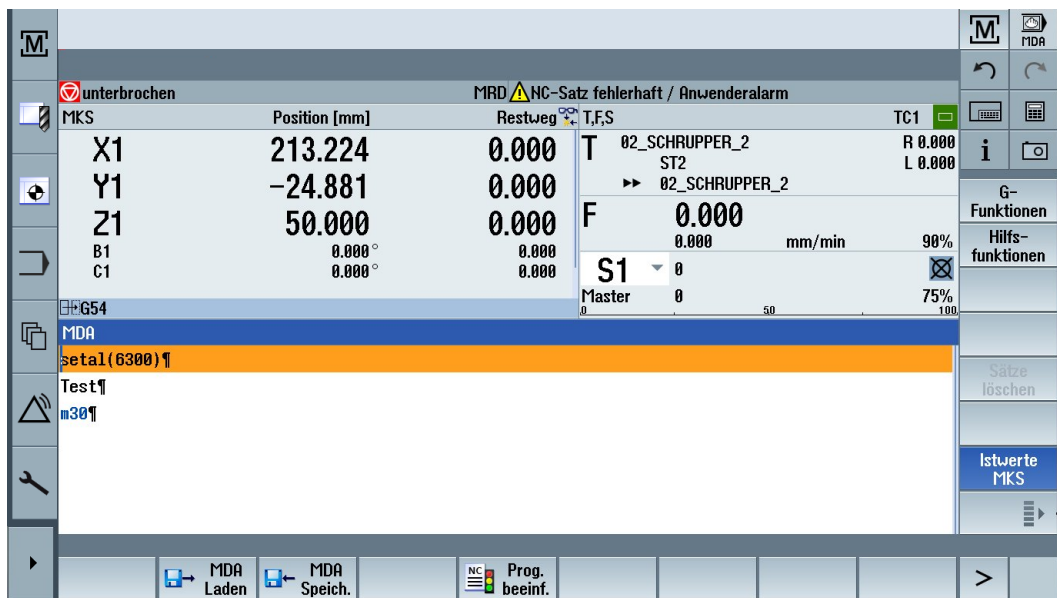

3.5.2 Sidescreen with standard windows

When the sidescreen is activated, a navigation bar is shown on the left-hand side of the user interface.

This navigation bar can be used to switch directly to the desired operating area, and to show and hide the sidescreen.



Navigation bar

Operator control	Function
	Opens the "Machinery" operating area.
	Opens the tool list in the "Parameter" operating area.
	Opens the "Work offset" window in the "Parameter" operating area.
	Opens the "Program" operating area.
	Opens the "Program manager" operating area.
	Opens the "Diagnostics" operating area.
	Opens the "Commissioning" operating area.
	Hides the sidescreen.
	Shows the sidescreen.

3.5.3 Standard widgets

Open sidescreen

- Tap the arrow on the navigation bar to show the sidescreen.
The standard widgets are displayed in minimized form as the header line.

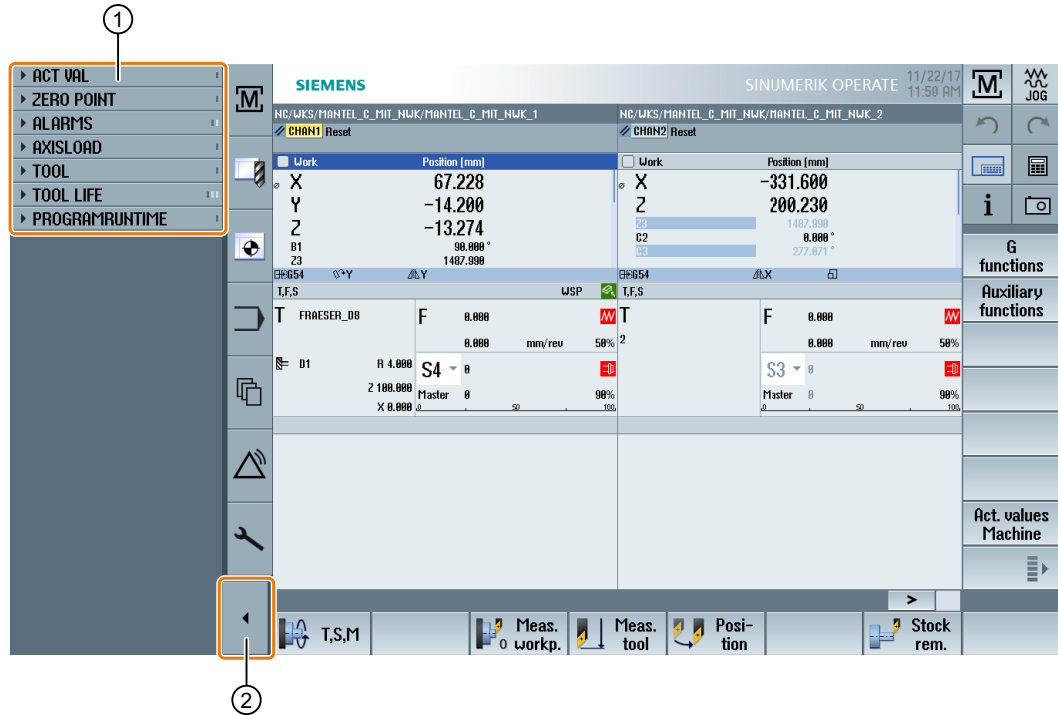

- ① Widget header lines
- ② Arrow key for showing/hiding the sidescreen

Navigating in sidescreen

- To scroll through the list of widgets, swipe vertically with 1 finger.
- OR -
- To return to the end or to the beginning of the list of widgets, swipe vertically with 3 fingers.

Open widgets

- To open a widget, tap the header line of the widget.

3.5.4 "Actual value" widget

The widget contains the position of the axes in the displayed coordinate system.

The distance-to-go for the current NC block is displayed while a program is running.

3.5 Expansion with side screen

▼ ACT VAL		
Work	Position [mm]	Dist-to-go
X	67.228	0.000
Y	-14.200	0.000
Z	-13.274	0.000
B1	90.000 °	0.000
Z3	1407.990	0.000

3.5.5 "Zero point" widget

The widget includes values of the active work offset for all configured axes.

The approximate and detailed offset, as well as rotation, scaling and mirroring are displayed for each axis.

▼ ZERO POINT			
G54	Coarse	Fine	
X	14.230	0.216	↺ ↻
Y	-14.200		↺ ↻
Z	300.000	-0.230	
B1			
Z3	12.010	0.246	

3.5.6 "Alarms" widget

The widget contains all the messages and alarms in the alarm list.

The alarm number and description are displayed for every alarm. An acknowledgment symbol indicates how the alarm is acknowledged or canceled.

Vertical scrolling is possible if multiple alarms are pending.

Wipe horizontally to switch between alarms and messages.

▼ ALARMS	
⊖ 16906	Channel 1: Program control: action 'Start selected processing' is canceled due to an alarm
⊘ 61237	Channel 1: Block 1: Retraction direction unknown. Withdraw tool manually!

3.5.7 "Axle load" widget

The widget shows the load on all axes in a bar chart.

Up to 6 axes are displayed. Vertical scrolling is possible if multiple axes are present.

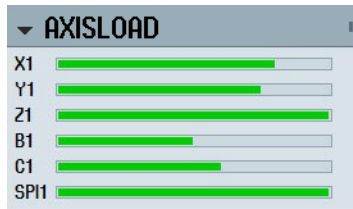

3.5.8 "Tool" widget

The widget contains the geometry and wear data for the active tool.

The following information is additionally displayed depending on the machine configuration:

- EC: Active location-dependent offset - setting up offset
- SC: Active location-dependent offset - additive offset
- TOFF: Programmed tool length offset in WCS coordinates, and programmed tool radius offset
- Override: Value of the overridden movements that were made in the individual tool directions

The screenshot shows a widget titled "TOOL" with a dropdown arrow on the left. Below the title, there is a table with the following data:

FRAESER_D8			
D1	Length X	Length Z	Radius
Geometry		100.000	4.000
Wear			
EC			
SC			

3.5.9 "Service life" widget

The widget displays the tool monitoring in relation to the following values:

- Operating time of tool (standard time monitoring)
- Finished workpieces (quantity monitoring)
- Tool wear (wear monitoring)

Note

Multiple cutting edges

If a tool has multiple cutting edges, the values of the edge with the lowest residual service life, quantity and wear is displayed.

It possible to alternate between views by scrolling horizontally.

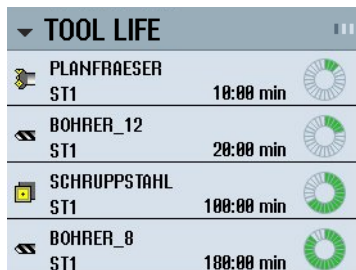

3.5.10 "Program runtime" widget

The widget contains the following data:

- Total runtime of the program
- Time remaining to end of program

This data is estimated for the first program run.

Additionally, progress of the program is visualized in a bar chart as a percentage.



3.5.11 Sidescreen with pages for the ABC keyboard and/or machine control panel

Not only standard widgets but also pages with ABC keyboards and machine control panels can be configured in the sidescreen of a multitouch panel.

Configure ABC keyboard and MCP

If you configured ABC keyboard and MCP keys, then the navigation bar is extended for the sidescreen:

Operator control	Function
	Display of standard widgets in the sidescreen
	Display of an ABC keyboard on the sidescreen
	Display of a machine control panel on the sidescreen

3.5.12 Example 1: ABC keyboard in the sidescreen

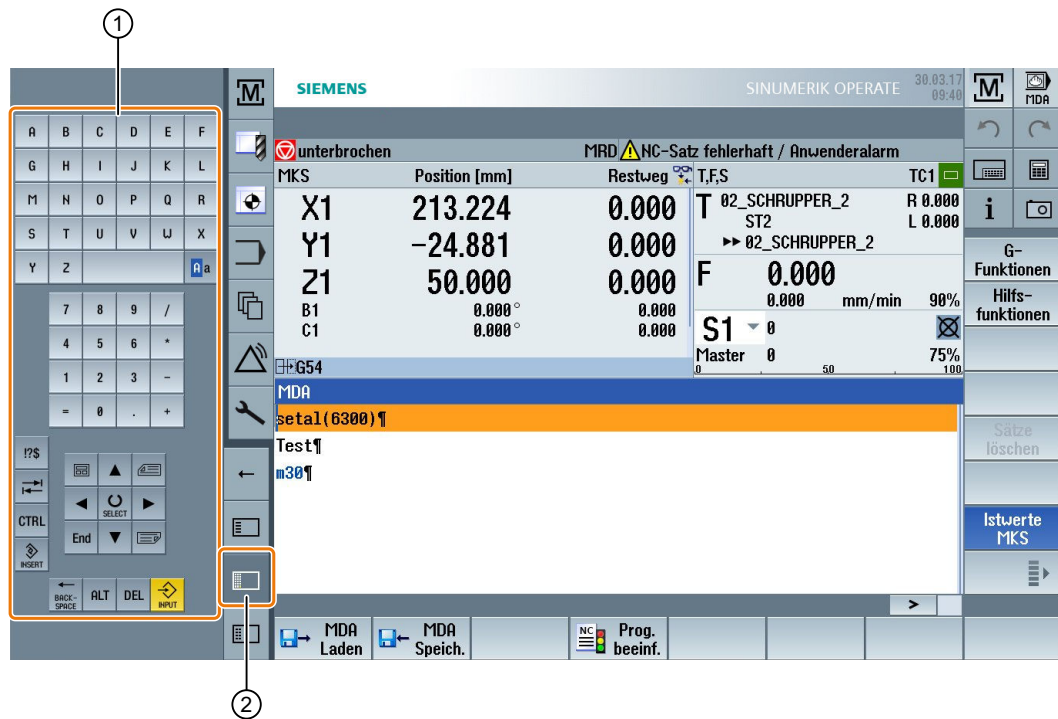

- ① ABC keyboard
- ② Key to display the keyboard

3.5.13 Example 2: Machine control panel in the sidescreen

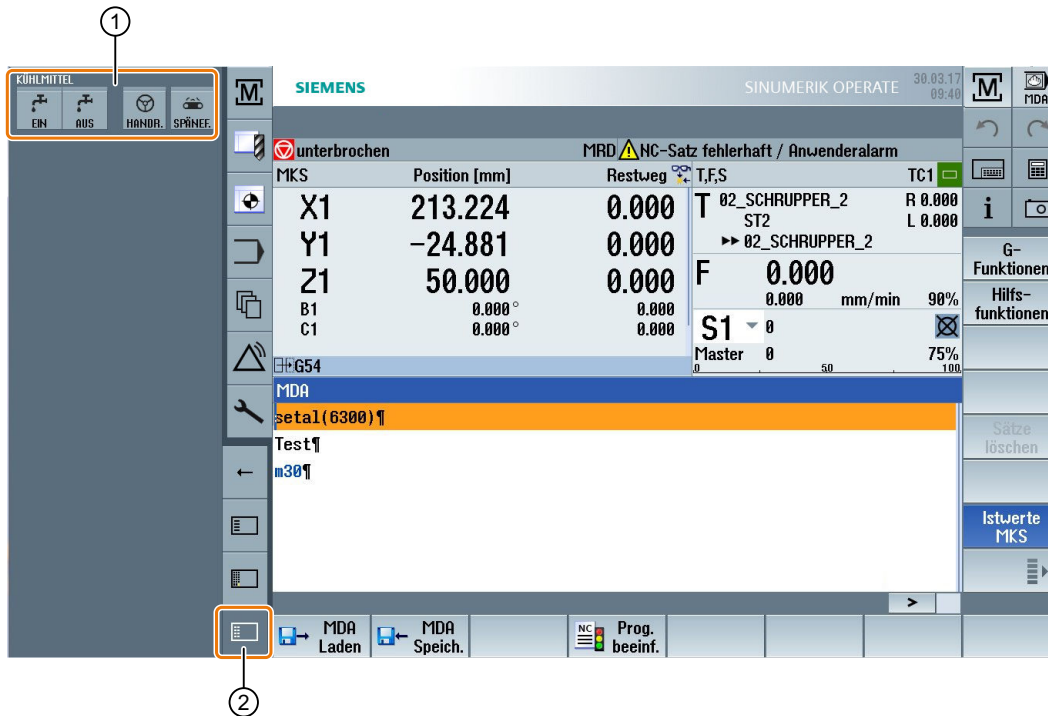

- ① Machine control panel
- ② Key to display the machine control panel

3.6 SINUMERIK Operate Display Manager (840D sl only)

3.6.1 Overview

With a panel with full HD resolution (1920x1080), you have the possibility to work with the Display Manager.

The Display Manager permits you to see a lot of information at a glance.

With the Display Manager, the screen area is divided into several display areas.

In addition to SINUMERIK Operate, widgets, keyboards, a machine control panel and various applications are provided in the various areas.



Software option

The option "P81 – SINUMERIK Operate Display Manager" is required for the "SINUMERIK Operate Display Manager" function.

References

For further information on the activation and configuration of the Display Manager, please refer to:

- SINUMERIK Operate (IM9) / SINUMERIK 840D sl Commissioning Manual

For further information on Full HD Panels, please refer to:

- Operator panel fronts manual: TOP 1500, TOP 1900, TOP 2200 / SINUMERIK 840D sl

3.6.2 Screen layout

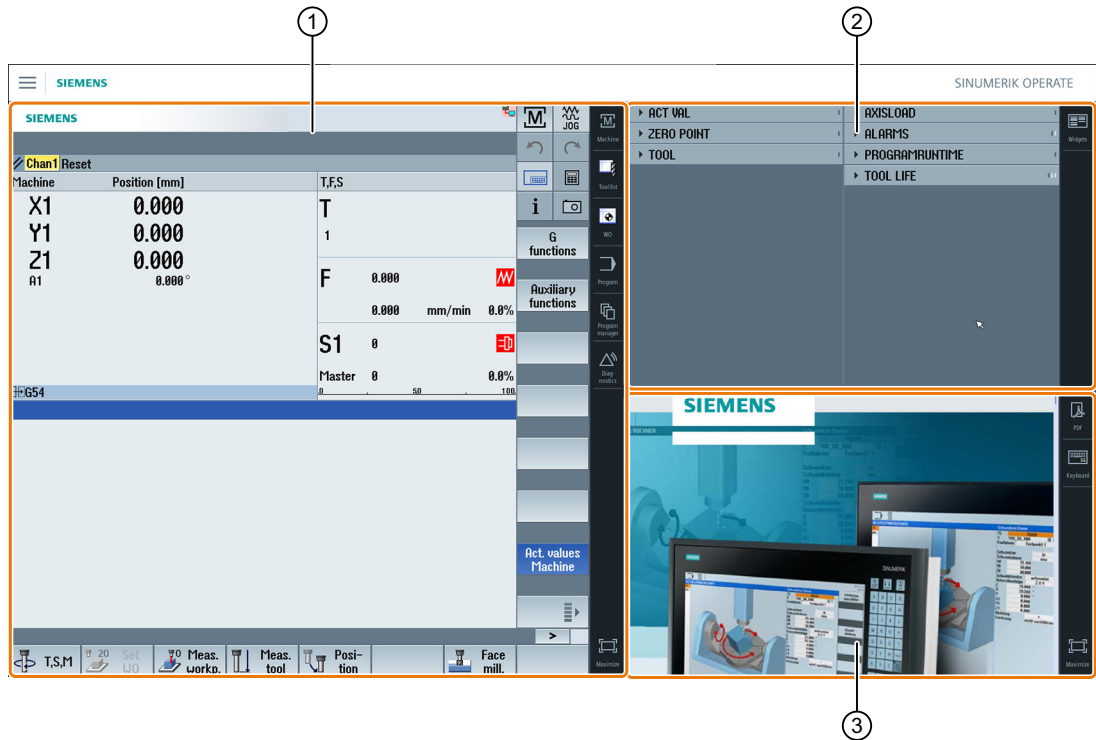

The standard supply of a SINUMERIK Operate Display Manager offers the option of choosing between 3-display areas and 4-display areas.









- ① SINUMERIK Operate with navigation bar for switchover of the operating area
- ② Display area for standard widgets
- ③ Display area for applications (e.g. PDF)



3.6.3 Operator controls

The Display Manager is activated.

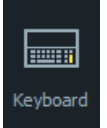
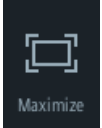
Operator control	Function
	Menu Tap on the menu to select the desired arrangement of the display areas.
	3 display areas <ul style="list-style-type: none"> • SINUMERIK Operate (with function block) • Widget area • Applications area (PDF, virtual keyboard)

Operator control	Function
	<p>4 display areas</p> <ul style="list-style-type: none"> • SINUMERIK Operate (with function block) • Widget area • Applications area (PDF, virtual keyboard) • Area with virtual keyboard
	<p>Mirroring display areas</p> <p>Mirrors the selected arrangement of the display areas.</p>
 <p>Machine</p> <p>...</p>  <p>Diag-nostics</p>	<p>Navigating in SINUMERIK Operate</p> <p>Tap on the corresponding icon to directly open the desired operating area.</p>
 <p>Widgets</p>	<p>Widgets</p> <p>The following widgets are available by default:</p> <ul style="list-style-type: none"> • Actual values (Page 79) • Zero point (Page 80) • Tool (Page 81) • Axle load (Page 80) • Alarms (Page 80) • Program runtime (Page 82) • Service life (Page 81)
 <p>PDF</p>	<p>PDF</p> <p>Opens the PDF stored here.</p>
 <p>Keyboard</p>  <p>Keyboard</p>	<p>Virtual keyboard</p> <p>Displays a QWERTY keyboard in the display area for applications as well as in the 4th display area below SINUMERIK Operate.</p> <p>If the virtual keyboard is selected while the maximum representation of the display area is active, the keyboard opens as a pop-up. The keyboard can be moved as required on the display by means of touch operation.</p>
 <p>Maximize</p>	<p>Maximizing the display area</p> <p>Enlarges the area with the SINUMERIK Operate and the area for the applications to the full extent of the panel.</p>

3.6 SINUMERIK Operate Display Manager (840D sl only)

Operator control	Function
	<p>Minimizing the display area The area with the SINUMERIK Operate and the area for the applications are reduced back to their original size.</p>
	<p>Machine Control Panel Shows a machine control panel.</p> <p>Note: Please observe the information provided by the machine manufacturer.</p>

Setting up the machine

4.1 Switching on and switching off

Startup

Machine	Position [mm]	Feed/override
X1	0.000	0.000 mm/min 80%
Y1	0.000	0.000 mm/min 80%
Z1	0.000	0.000 mm/min 80%
SP1	0.000 °	0.000 °/min 80%

F=0.000

When the control starts up, the main screen opens according to the operating mode specified by the machine manufacturer. In general, this is the main screen for the "REF POINT" submode.



Machine manufacturer

Please refer to the machine manufacturer's specifications.

4.2 Approaching a reference point

4.2.1 Referencing axes

Your machine tool can be equipped with an absolute or incremental path measuring system. An axis with incremental path measuring system must be referenced after the controller has been switched on – however, an absolute path measuring system does not have to be referenced.

For the incremental path measuring system, all the machine axes must therefore first approach a reference point, the coordinates of which are known to be relative to the machine zero-point.

Sequence

Prior to the approach, the axes must be in a position from where they can approach the reference point without a collision.

The axes can also all approach the reference point simultaneously, depending on the manufacturer's settings.



Machine manufacturer

Please refer to the machine manufacturer's specifications.

NOTICE

Risk of collision

If the axes are not in a collision-free position, you must first traverse them to safe positions in "JOG" or "MDI" mode.

You must follow the axis motions directly on the machine!

Ignore the actual value display until the axes have been referenced!

The software limit switches are not active!

Procedure



1. Press the <JOG> key.



2. Press the <REF. POINT> key.



3. Select the axis to be traversed.





4. Press the <-> or <+> key.

The selected axis moves to the reference point.



If you have pressed the wrong direction key, the action is not accepted and the axes do not move.



A symbol is shown next to the axis if it has been referenced.

The axis is referenced as soon as the reference point is reached. The actual value display is set to the reference point value.

From now on, path limits, such as software limit switches, are active.

End the function via the machine control panel by selecting operating mode "AUTO" or "JOG".

4.2.2 User agreement

If you are using Safety Integrated (SI) on your machine, you will need to confirm that the current displayed position of an axis corresponds to its actual position on the machine when you reference an axis. Your confirmation is the requirement for the availability of other Safety Integrated functions.

You can only give your user agreement for an axis after it has approached the reference point.

The displayed axis position always refers to the machine coordinate system (Machine).

Option

User agreement with Safety Integrated is only possible with a software option.

Procedure



1. Select the "Machine" operating area.



2. Press the <REF POINT> key.



3. Select the axis to be traversed.



4. Press the <-> or <+> key.

The selected axis moves to the reference point and stops. The coordinate of the reference point is displayed.



The axis is marked with .

4.2 Approaching a reference point



5. Press the "User enable" softkey.
The "User Agreement" window opens.
It shows a list of all machine axes with their current position and SI position.
6. Position the cursor in the "Acknowledgement" field for the axis in question.
7. Activate the acknowledgement with the <SELECT> key.



The selected axis is marked with an "x" meaning "safely referenced" in the "Acknowledgement" column.



By pressing the <SELECT> key again, you deactivate the acknowledgement again.

4.3 Modes and mode groups

4.3.1 General

You can work in three different operating modes.

"JOG" mode

"JOG" mode is used for the following preparatory actions:

- Approach reference point, i.e. the machine axis is referenced
- Preparing a machine for executing a program in automatic mode, i.e. measuring tools, measuring the workpiece and, if necessary, defining the work offsets used in the program
- Traversing axes, e.g. during a program interruption
- Positioning axes

Select "JOG"



Press the <JOG> key.

"REF POINT" operating mode

The "REF POINT" operating mode is used to synchronize the control and the machine. For this purpose, you approach the reference point in "JOG" mode.

Selecting "REF POINT"



Press the <REF POINT> key.

"REPOS" operating mode

The "REPOS" operating mode is used for repositioning to a defined position. After a program interruption (e.g. to correct tool wear values) move the tool away from the contour in "JOG" mode.

The distances traversed in "JOG" mode are displayed in the actual value window as the "Repos" offset.

"REPOS" offsets can be displayed in the machine coordinate system (MCS) or workpiece coordinate system (WCS).

Selecting "Repos"



Press the <REPOS> key.

"MDI" mode (Manual Data Input)

In "MDI" mode, you can enter and execute G code commands non-modally to set up the machine or to perform a single action.

Selecting "MDI"



Press the <MDI> key.

"AUTO" mode

In automatic mode, you can execute a program completely or only partially.

Select "AUTO"



Press the <AUTO> key.

"TEACH IN" operating mode

"TEACH IN" is available in the "AUTO" and "MDI" operating modes.

There you may create, edit and execute part programs (main programs or subroutines) for motional sequences or simple workpieces by approaching and saving positions.

Selecting "Teach In"



Press the <TEACH IN> key.

4.3.2 Modes groups and channels

Every channel behaves like an independent NC. A maximum of one part program can be processed per channel.

- Control with 1 channel
One mode group exists.
- Control with several channels
Channels can be grouped to form several "mode groups."

Example

Control with 4 channels, where machining is carried out in 2 channels and 2 other channels are used to control the transport of the new workpieces.

Mode group 1 channel 1 (machining)

Channel 2 (transport)

Mode group 2 channel 3 (machining)

Channel 4 (transport)

Mode groups (MGs)

Technologically-related channels can be combined to form a mode group.

Axes and spindles of the same mode group can be controlled by one or more channels.

An operating mode group is in one of "Automatic", "JOG" or "MDI" operating modes, i.e., several channels of an operating mode group can never assume different operating modes.

4.3.3 Channel switchover

It is possible to switch between channels when several are in use. Since individual channels may be assigned to different mode groups, a channel switchover command is also an implicit mode switchover command.

When a channel menu is available, all of the channels are displayed on softkeys and can be switched over.

Changing the channel



Press the <CHANNEL> key.

The channel changes over to the next channel.

- OR -

If the channel menu is available, a softkey bar is displayed. The active channel is highlighted.

Another channel can be selected by pressing one of the other softkeys.

References

SINUMERIK Operate Commissioning Manual

4.4 Settings for the machine

4.4.1 Switching over the coordinate system (MCS/WCS)

The coordinates in the actual value display are relative to either the machine coordinate system or the workpiece coordinate system.

By default, the workpiece coordinate system is set as a reference for the actual value display.

The machine coordinate system (MCS), in contrast to the workpiece coordinate system (WCS), does not take into account any zero offsets, tool offsets and coordinate rotation.

Procedure



1. Select the "Machine" operating area.



2. Press the <JOG> or <AUTO> key.



3. Press the "Act.vls. MCS" softkey.



The machine coordinate system is selected.
The title of the actual value window changes in the MCS.



Machine manufacturer

The softkey to changeover the coordinate system can be hidden. Please refer to the machine manufacturer's specifications.

4.4.2 Switching the unit of measurement

You can set millimeters or inches as the unit of measurement for the machine. Switching the unit of measurement always applies to the entire machine. All required information is automatically converted to the new unit of measurement, for example:

- Positions
- Tool offsets
- Zero offsets

The following conditions must be met before you can switch between units of measurement:

- The corresponding machine data are set.
- All channels are in the reset state.
- The axes are not being traversed via "JOG", "DRF", and the "PLC".
- Constant grinding wheel peripheral speed (GWPS) is not active.



Machine manufacturer

Please refer to the machine manufacturer's specifications.

References

For further information about switching between units of measurement, please refer to:

Function Manual, Basic Functions; Speeds, Setpoint/Actual-Value System, Closed-Loop Control (G2), Section "Metric/inch dimension system"

Procedure



Machine

1. Select the mode <JOG> or <AUTO> in the "Machine" operating area.



2. Press the menu forward key and the "Settings" softkey.
A new vertical softkey bar appears.



3. Press the "Switch to inch" softkey.
A prompt asks you whether you really want to switch over the unit of measurement.



4. Press the "OK" softkey.

The softkey label changes to "Switch to metric".

The unit of measurement applies to the entire machine.



5. Press the "Switch to metric" softkey to set the unit of measurement of the machine to metric again.

See also

Default settings for manual mode (Page 148)

4.4.3 Setting the zero offset

You can enter a new position value in the actual value display for individual axes when a settable zero offset is active.

The difference between the position value in the machine coordinate system MCS and the new position value in the workpiece coordinate system WCS is saved permanently in the currently active zero offset (e.g. G54).

Relative actual value

Further, you also have the possibility of entering position values in the relative coordinate system.

Note

The new actual value is only displayed. The relative actual value has no effect on the axis positions and the active zero offset.

Resetting the relative actual value



Press the "Delete REL" softkey.

The actual values are deleted.

The softkeys to set the zero point in the relative coordinate system are only available if the corresponding machine data is set.



Machine manufacturer

Please refer to the machine manufacturer's specifications.

Precondition

The controller is in the workpiece coordinate system.

The actual value can be set in both the Reset and Stop state.

Note

Setting the WO in the Stop state

If you enter the new actual value in the Stop state, the changes made are only visible and only take effect when the program is continued.

Procedure



1. Select the "JOG" mode in the "Machine" operating area.



2. Press the "Set WO" softkey.

- OR -



Press the ">>", "REL act. vals" and "Set REL" softkeys to set position values in the relative coordinate system.



3. Enter the new required position value for Z, X or Y directly in the actual value display (you can toggle between the axes with the cursor keys) and press the <INPUT> key to confirm the entries.



- OR -

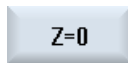

Press softkey "Z=0", "X=0" or "Y=0" (if there is a Y axis), to set the required position to zero.

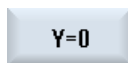
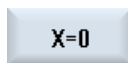

Resetting the actual value



Press the "Delete active WO" softkey.
The offset is deleted permanently.

NOTICE

Irreversible active zero offset

The current active zero offset is irreversibly deleted by this action.

4.5 Measuring the tool

The geometries of the machining tool must be taken into consideration when executing a part program. These are stored as tool offset data in the tool list. Each time the tool is called, the control considers the tool offset data.

When programming the part program, you only need to enter the workpiece dimensions from the production drawing. After this, the controller independently calculates the individual tool path.

Drilling and milling tools

You can determine the tool offset data, i.e. the length and radius or diameter, either manually or automatically with tool probes.

Turning tools

You can specify the tool offset data, i.e. the length, either manually or automatically using a tool probe.



Machine manufacturer

Please refer to the machine manufacturer's specifications.

Logging measurement results

After you have completed the measurement, you have the option to output the displayed values to a log. You can define whether the log file that is generated is continually written to for each new measurement, or is overwritten.

See also

Logging tool measurement results (Page 106)

Settings for the measurement result log (Page 110)

4.5.1 Measuring a tool manually

When measuring manually, traverse the tool manually to a known reference point in order to determine the tool dimensions in the X and Z directions. The control system then calculates the tool offset data from the position of the tool carrier reference point and the reference point.

Reference point

The workpiece edge is used as the reference point when measuring length X and length Z. The chuck of the main or counterspindle can also be used when measuring in the Z direction.

You specify the position of the workpiece edge during the measurement.

Note

Lathes with B axis

For lathes with a B axis, execute the tool change and alignment in the T, S, M window before performing the measurement.

Procedure



1. Select "JOG" mode in the "Machine" operating area.



2. Press the "Meas. tool" softkey.



3. Press the "Manual" softkey.



4. Press the "Select tool" softkey.
The "Tool selection" window is opened.



5. Select the tool that you wish to measure.
The cutting edge position and the radius or diameter of the tool must already be entered in the tool list.



6. Press the "In manual" softkey.
The tool is accepted into the "Length Manual" window.



7. Press the "X" or "Z" softkey, depending on which tool length you want to measure.

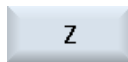

8. Scratch the required edge using the tool.



9. If you do not wish to keep the tool at the workpiece edge, then press the "Save position" softkey.

The tool position is saved and the tool can be retracted from the workpiece. For instance, this can be practical if the workpiece diameter still has to be subsequently measured.

If the tool can remain at the workpiece edge, then after scratching you can directly continue with step 11.



10. Enter the position of the workpiece edge in X0 or Z0.
If no value is entered for X0 or Z0, the value is taken from the actual value display.
11. Press the "Set length" softkey.
The tool length is calculated automatically and entered in the tool list. Whereby the cutting edge position and tool radius or diameter are automatically taken into consideration as well.

Note

Tool measurement is only possible with an active tool.

4.5.2 Measuring a tool with a tool probe

During automatic measuring, you determine the tool dimensions in the directions X and Z with the aid of a probe.

You have the possibility of measuring a tool using a tool holder that can be orientated (tool carrier, swivel).

The function "Measure with tool carrier that can be orientated" is implemented for lathes with a swivel axis around Y and associated tool spindle. The swivel axis can be used to align the tool on the X/Z level. The swivel axis can assume any position around Y to measure turning tools. Multiples of 90° are permitted for milling and drilling tools. Multiples of 180° are possible when positioning the tool spindle.

Note

Lathes with B axis

For lathes with a B axis, execute the tool change and alignment in the T, S, M window before performing the measurement.

Adapting the user interface to calibrating and measuring functions

The corresponding windows can be adapted to the measurement tasks in order to automatically measure tools.

The tool offset data is calculated from the known position of the tool carrier reference point and the probe.

The following selection options can be switched-in or switched-out:

- Calibration plane, measurement plane
- Probe
- Calibration feedrate (measuring feedrate)

References

For further information about lathes with B axis, please refer to the following reference:

SINUMERIK Operate Commissioning Manual

Preconditions

- If you wish to measure your tools with a tool probe, the machine manufacturer must parameterize special measuring functions for that purpose.
- Enter the cutting edge position and the radius or diameter of the tool in the tool list before performing the actual measurement. If the tool is measured using a tool carrier that can be orientated, then the cutting edge position must be entered into the tool list corresponding to the initial tool carrier position.
- Calibrate the probe first.



Machine manufacturer

Please refer to the machine manufacturer's specifications.

Procedure

1. Insert the tool that you want to measure.
If the tool is to be measured using a tool carrier that can be orientated, then at this position the tool should be aligned in the same way that it will be subsequently measured.
2. Select "JOG" mode in the "Machine" operating area.
3. Press the "Meas. tool" and "Automatic" softkeys.
4. Press the "X" or "Z" softkey, depending on which tool length you want to measure.

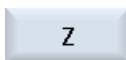



5. Manually position the tool in the vicinity of the tool probe in such a way that any collisions can be avoided when the tool probe is being traversed in the corresponding direction.

6. Press the <CYCLE START> key.

The automatic measuring process is started, i.e. the tool is traversed at the measurement feedrate to the probe and back again.

The tool length is calculated and entered in the tool list. Whereby the cutting edge position and tool radius or diameter are automatically taken into consideration as well.

If turning tools with tool carrier that can be oriented are measured around Y using any positions (not multiples of 90°) of the swivel axis, then it should be taken into consideration that the turning tool is measured with the same tool position in both axes X/Z, assuming that this is possible.

4.5.3 Calibrating the tool probe

To be able to measure your tools automatically, you must first determine the position of the tool probe in the machine area in relation to the machine zero.



Machine manufacturer

Please refer to the machine manufacturer's specifications.

Sequence

The calibrating tool must be a turning tool type (roughing or finishing tool). Cutting edge positions 1 - 4 can be used for the tool probe calibration. You must enter the length and the radius or diameter of the calibrating tool in the tool list.

Calibrate the probe in all directions in which you wish to subsequently perform measurements.

Procedure



1. Change the calibrating tool.
2. Select the "JOG" mode in the "Machine" operating area.



3. Press the "Meas. tool" and "Calibrate probe" softkeys.

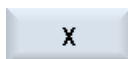

4. Press the "X" or "Z" softkey, depending on which point of the tool probe you wish to determine first.

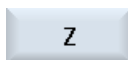



5. Select the direction (+ or -), in which you would like to approach the tool probe.

6. Position the calibrating tool in the vicinity of the tool probe in such a way that any collisions can be avoided when the first point of the tool probe is being approached.



7. Press the <CYCLE START> key.

The calibration process is started, i.e. the calibrating tool is automatically traversed at the measurement feedrate to the probe and back again. The position of the tool probe is determined and saved in an internal data area.

8. Repeat the process for the other other points of the tool probe.

4.5.4 Measuring a tool with a magnifying glass

You can also use a magnifying glass to determine the tool dimensions, if this is available on the machine.

In this case, SINUMERIK Operate calculates the tool offset data from the known positions of the tool carrier reference point and the cross-hairs of the magnifying glass.

Note

Lathes with B axis

For lathes with a B axis, execute the tool change and alignment in the T, S, M window before performing the measurement.

Procedure



1. Select the "JOG" mode in the "Machine" operating area.



2. Press the "Meas. tool" softkey.



3. Press the "Zoom" softkey.



4. Press the "Select tool" softkey.
The "Tool selection" window is opened.

5. Select the tool that you wish to measure.
The cutting edge position and the radius or diameter of the tool must already be entered in the tool list.



6. Press the "In manual" softkey.
The tool is accepted in the "Zoom" window.



7. Traverse the tool towards the magnifying glass and align the tool tip P with the magnifying glass cross-hairs.
Press the "Set length" softkey.

4.5.5 Logging tool measurement results

After measuring a tool, you have the option to output the measured values to a log.

The following data are determined and logged:

- Date/time
- Log name with path
- Measuring version
- Input values
- Correction target
- Setpoints, measured values and differences

Note

Logging active

The measurement results can only be entered into a log once the measurement has been fully completed.

Procedure



1. You are in the "JOG" mode and have pressed the "Measure tool" softkey. The "Measurement log" softkey cannot be used.
2. Insert the tool, select the measuring version and measure the tool as usual.

The tool data are displayed once the measurement has been completed.

The "Measurement log" softkey can be operated.



3. Press the "Measurement log" softkey to save the measurement data as log.
The "Measurement log" softkey becomes inactive again.

See also

Settings for the measurement result log (Page 110)

4.6 Measuring the workpiece zero

4.6.1 Measuring the workpiece zero

The reference point for programming a workpiece is always the workpiece zero. To determine this zero point, measure the length of the workpiece and save the position of the cylinder's face surface in the direction Z in a zero offset. This means that the position is stored in the coarse offset and existing values in the fine offset are deleted.

Calculation

When the workpiece zero / zero offset is calculated, the tool length is automatically taken into account.

Measuring only

If you wish to measure the workpiece zero in "Measuring Only" mode, the measured values are merely displayed without any changes being made to the coordinate system.

Adapting the user interface to the measurement functions

The following selection options can be switched-in or switched-out:

- Calibration plane, measuring plane (only 840D sl)
- Zero offset as basis for the measuring process (only 840D sl)
- Number of the probe calibration data record (only 840D sl)
- Offset target, settable zero offset
- Offset target, basis reference
- Offset target, global basic zero offset (only 840D sl)
- Offset target, channel-specific basic zero offset (only 840D sl)



Machine manufacturer

Please refer to the machine manufacturer's specifications.

Logging the measurement result

After you have completed the measurement, you have the option to output the displayed values in a log. You can define whether the log file that is generated is continually written to for each new measurement, or is overwritten.

Precondition

The requirement for measuring the workpiece is that a tool with known lengths is in the machining position.

Procedure



1. Select "JOG" mode in the "Machine" operating area.



2. Press the "Workpiece zero" softkey.
The "Set Edge" window opens.



3. Select "Measuring only" if you only want to display the measured values.

- OR -



Select the desired zero offset in which you want to store the zero point (e.g. basis reference).

- OR -



Press the "Zero offset" softkey and select the zero offset in which the zero point is to be saved in the "Zero Offset – G54 ... G599" window that opens and press the "In Manual" softkey.

You return to the "Set Edge" window.



4. Traverse the tool in the Z direction and scratch the workpiece.



5. Enter the position setpoint of the workpiece edge Z0 and press the "Set ZO" softkey.

Note

Settable zero offsets

The labeling of the softkeys for the settable zero offsets varies, i.e. the settable zero offsets configured on the machine are displayed (examples: G54...G57, G54...G505, G54...G599).

Please refer to the machine manufacturer's specifications.

4.6.2 Logging measurement results for the workpiece zero

When measuring the workpiece zero, you have the option to output the values that have been determined to a log.

The following data are determined and logged:

- Date/time
- Log name with path
- Measuring version
- Input values
- Correction target
- Setpoints, measured values and differences

Note

Logging active

The measurement results can only be entered into a log once the measurement has been fully completed.

Procedure



1. You are in the "JOG" mode and have pressed the "Workpiece zero" softkey.
The "Measurement log" softkey cannot be used.
2. Select the required measurement version and measured the workpiece zero as usual.
The measured values are displayed once the measurement has been completed.











2. Press the "Measurement log" softkey to save the measurement data as log.
The "Measurement log" softkey becomes inactive again.

4.7 Settings for the measurement result log

Make the following settings in the "Settings for measurement log" window:

- Log format
 - Text format
The log in the text format is based on the display of the measurement results on the screen.
 - Tabular format
When selecting the tabular format, the measurement results are saved so that the data can be imported into a spreadsheet program (e.g. Microsoft Excel). This allows the measurement result logs to be statistically processed.
- Log data
 - new
The log of the actual measurement is created under the specified name. Existing logs with the same name are overwritten.
 - attach
The log created is attached to the previous log.
- Where the log is saved
The log created is saved in a specified directory.

Procedure

- | | |
|---|---|
|  | 1. Select the "Machine" operating area. |
|  | 2. Press the <JOG> key. |
|  | 3. Press the menu forward key and the "Settings" softkey. |
|  | |
|  | 4. Press the "Measurement log" softkey.
The "Settings for measurement log" window is opened. |
|  | 5. Position the cursor to the log format field and select the required entry. |
|  | 6. Position the cursor to the log data field and select the required entry. |
|  | 7. Position the cursor to the log archive field and press the softkey "Select directory". |
| | 8. Navigate to the desired directory for the log archive. |
|  | 9. Press the "OK" softkey and enter the name for the log file. |

See also

Logging tool measurement results (Page 106)

Logging measurement results for the workpiece zero (Page 108)

4.8 Zero offsets

Following reference point approach, the actual value display for the axis coordinates is based on the machine zero (M) of the machine coordinate system (Machine). The program for machining the workpiece, however, is based on the workpiece zero (W) of the workpiece coordinate system (Work). The machine zero and workpiece zero are not necessarily identical. The distance between the machine zero and the workpiece zero depends on the workpiece type and how it is clamped. This zero offset is taken into account during execution of the program and can be a combination of different offsets.

Following reference point approach, the actual value display for the axis coordinates is based on the machine zero of the machine coordinate system (Machine).

The actual value display of the positions can also refer to the SZS coordinate system (settable zero system). The position of the active tool relative to the workpiece zero is displayed.

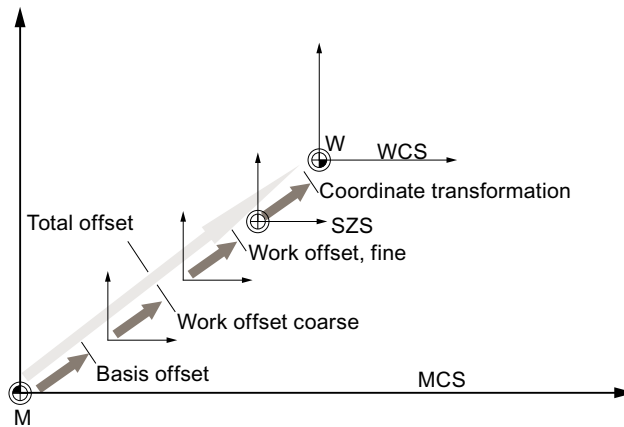

Figure 4-1 Zero offsets

When the machine zero is not identical to the workpiece zero, at least one offset (base offset or zero offset) exists in which the position of the workpiece zero is saved.

Base offset

The base offset is a zero offset that is always active. If you have not defined a base offset, its value will be zero. The base offset is specified in the "Zero Offset - Base" window.

Coarse and fine offsets

Every zero offset (G54 to G57, G505 to G599) consists of a coarse offset and a fine offset. You can call the zero offsets from any program (coarse and fine offsets are added together).

You can save the workpiece zero, for example, in the coarse offset, and then store the offset that occurs when a new workpiece is clamped between the old and the new workpiece zero in the fine offset.

Note

Deselect fine offset (only 840D sl)

You have the option of deselecting the fine offset using machine data MD18600
`$MN_MM_FRAME_FINE_TRANS`

See also

Actual value window (Page 45)

4.8.1 Display active zero offset

The following zero offsets are displayed in the "Zero Offset - Active" window:

- Zero offsets, for which active offsets are included, or for which values are entered.
- Settable zero offsets
- Total zero offset

This window is generally used only for monitoring.

The availability of the offsets depends on the setting.

**Machine manufacturer**

Please refer to the machine manufacturer's specifications.

Procedure

1. Select the "Parameter" operating area.



2. Press the "Zero offset" softkey.
The "Zero Offset - Active" window is opened.

**Note****Further details on zero offsets**

If you would like to see further details about the specified offsets or if you would like to change values for the rotation, scaling or mirroring, press the "Details" softkey.

4.8.2 Displaying the zero offset "overview"

The active offsets or system offsets are displayed for all axes that have been set up in the "Work offset - overview" window.

4.8 Zero offsets

In addition to the offset (course and fine), the rotation, scaling and mirroring defined using this are also displayed.

This window is generally used only for monitoring.

Display of active work offsets

Work offsets	
DRF	Displays the handwheel axis offset.
Rotary table reference	Displays the additional work offsets programmed with \$ P_PART-FRAME.
Basic reference	Displays the additional work offsets programmed with \$P_SETFRAME. Access to the system offsets is protected via a keyswitch.
External WO frame	Displays the additional work offsets programmed with \$P_EXTFRAME.
Total base WO	Displays all effective basis offsets.
G500	Displays the work offsets activated with G54 - G599. Under certain circumstances, you can change the data using "Set WO", i.e. you can correct a zero point that has been set.
Tool reference	Displays the additional work offsets programmed with \$P_TOOLFRAME.
Workpiece reference	Displays the additional work offsets programmed with \$P_WPFRAME.
Programmed WO	Displays the additional work offsets programmed with \$P_PFRAME.
Cycle reference	Displays the additional work offsets programmed with \$P_CYCFRAME.
Total WO	Displays the active work offset, resulting from the total of all work offsets.

Procedure

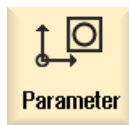

1. Select the "Parameter" operating area.



2. Press the "Work offset" and "Overview" softkeys. The "Work offsets - Overview" window opens.



4.8.3 Displaying and editing base zero offset

The defined channel-specific and global base offsets, divided into coarse and fine offsets, are displayed for all set-up axes in the "Zero offset - Base" window.



Machine manufacturer

Please refer to the machine manufacturer's specifications.

Procedure

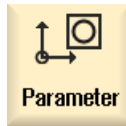

1. Select the "Parameter" operating area.



2. Press the "Zero offset" softkey.



3. Press the "Base" softkey.
The "Zero Offset - Base" window is opened.
4. You can edit the values directly in the table.

Note

Activate base offsets

The offsets specified here are immediately active.

4.8.4 Displaying and editing settable zero offset

All settable offsets, divided into coarse and fine offsets, are displayed in the "Work offset - G54...G599" window.

Rotation, scaling and mirroring are displayed.

Procedure



1. Select the "Parameter" operating area.



2. Press the "Work offset" softkey.



3. Press the "G54 ... G599" softkey.
The "Work offset - G54 ... G599 [mm]" window opens.

Note

The labeling of the softkeys for the settable work offsets varies, i.e. the settable work offsets configured on the machine are displayed (examples: G54 ... G57, G54 ... G505, G54 ... G599).

Please observe the information provided by the machine manufacturer.

4. You can edit the values directly in the table.

Note

Activate settable zero offsets

The settable zero offsets must first be selected in the program before they have an impact.

4.8.5 Displaying and editing details of the zero offsets

For each zero offset, you can display and edit all data for all axes. You can also delete zero offsets.

For every axis, values for the following data will be displayed:

- Coarse and fine offsets
- Rotation
- Scaling
- Mirroring



Machine manufacturer

Please refer to the machine manufacturer's specifications.

Note

Settings for rotation, scaling and mirroring are specified here and can only be changed here.

Tool details

You can display the following details for the tool and wear data for tools:

- TC
- Adapter dimension
- Length / length wear
- EC setup correction
- SC sum correction
- Total length
- Radius / radius wear



You can also change the display of the tool correction values between the Machine Coordinate System and the Workpiece Coordinate System.

**Machine manufacturer**

Please refer to the machine manufacturer's specifications.

Procedure

Parameter

1. Select the "Parameter" operating area.

Work
offset

2. Press the "Zero offset" softkey.



Active

3. Press the "Active", "Base" or "G54...G599" softkey.
The corresponding window opens.



G54...G599

4. Place the cursor on the desired zero offset to view its details.



Details

5. Press the "Details" softkey.

A window opens, depending on the selected zero offset, e.g. "Zero Offset - Details: G54 to G599".

6. You can edit the values directly in the table.

- OR -

Clear
WO

Press the "Clear offset" softkey to reset all entered values.

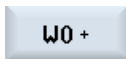

WO +

Press the "ZO +" or "ZO -" softkey to select the next or previous offset, respectively, within the selected area ("Active", "Base", "G54 to G599") without first having to switch to the overview window.

...



WO -

If you have reached the end of the range (e.g. G599), you will switch automatically to the beginning of the range (e.g. G54).

These value changes are available in the part program immediately or after "Reset".

**Machine manufacturer**

Please refer to the machine manufacturer's specifications.

<<
Back

- Press the "Back" softkey to close the window.

4.8.6 Deleting a zero offset

You have the option of deleting work offsets. This resets the entered values.

Procedure

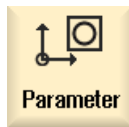

1. Select the "Parameter" operating area.



2. Press the "Work offset" softkey.



3. Press the "Overview", "Basis" or "G54...G599" softkey.

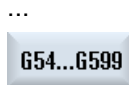

4. Press the "Details" softkey.



5. Position the cursor on the work offset you would like to delete.

6. Press the "Clear offset" softkey.

A confirmation prompt is displayed as to whether you really want to delete the work offset.



7. Press the "OK" softkey to confirm that you wish to delete the work offset.

4.8.7 Measuring the workpiece zero

Procedure



1. Select the "Parameters" operating area and press the "Zero offset" softkey.



2. Press the "G54...G599" softkey and select the zero offset in which the zero point is to be saved.



3. Press the "Workpiece zero" softkey.



You change to the "Set Edge" window in the "JOG" mode.



4. Traverse the tool in the Z direction and scratch it.
5. Enter the position setpoint of the workpiece edge Z0 and press the "Set Z0" softkey.

4.9 Monitoring axis and spindle data

4.9.1 Specify working area limitations

Using the "Working area limitation" function you can limit the range within which a tool should traverse in all channel axes. This function allows you to set up protection zones in the working area that are inhibited for tool motion.

In this way, you are able to restrict the traversing range of the axes in addition to the limit switches.

Requirements

You can only make changes in "AUTO" mode when in the RESET condition. These changes are then immediate.

You can make changes in "JOG" mode at any time. These changes, however, only become active at the start of a new motion.

Procedure

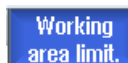

1. Select the "Parameter" operating area.

2. Press the "Setting data" softkey.

The "Working Area Limitation" window appears.

3. Place the cursor in the required field and enter the new values via the numeric keyboard.

The upper or lower limit of the protection zone changes according to your inputs.

4. Click the "active" checkbox to activate the protection zone.

Note

You will find all of the setting data in the "Start-up" operating area under "Machine data" via the menu forward key.

4.9.2 Editing spindle data

The speed limits set for the spindles that must not be under- or overshoot are displayed in the "Spindles" window.

You can limit the spindle speeds in fields "Minimum" and "Maximum" within the limit values defined in the relevant machine data.

Spindle speed limitation at constant cutting rate

In field "Spindle speed limitation at G96", the programmed spindle speed limitation at constant cutting speed is displayed together with the permanently active limitations.

This speed limitation, for example, prevents the spindle from accelerating to the max. spindle speed of the current gear stage (G96) when performing tapping operations or machining very small diameters.

Note

The "Spindle data" softkey only appears if a spindle is configured.

Procedure



1. Select the "Parameter" operating area.



2. Press the "Setting data" and "Spindle data" softkeys. The "Spindles" window opens.



3. If you want to change the spindle speed, place the cursor on the "Maximum", "Minimum", or "Spindle speed limitation at G96" and enter a new value.

4.9.3 Spindle chuck data

You store the chuck dimensions of the spindles at your machine in the "Spindle Chuck Data" window.

Manually measuring a tool

If you want to use the chuck of the main or counter-spindle as a reference point during manual measuring, specify the chuck dimension ZC.

Main spindle

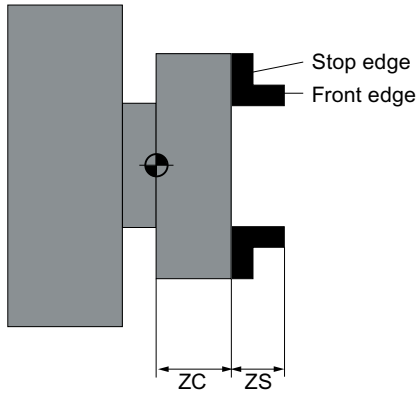

Dimensions, main spindle jaw type 1

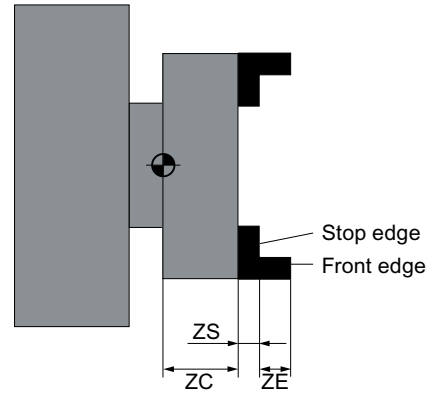

Dimensions, main spindle jaw type 2

Counter-spindle

You can measure either the forward edge or stop edge of the counter-spindle. The forward edge or stop edge automatically serves as the valid reference point when traversing the counter-spindle. This is especially important when gripping the workpiece using the counter-spindle.

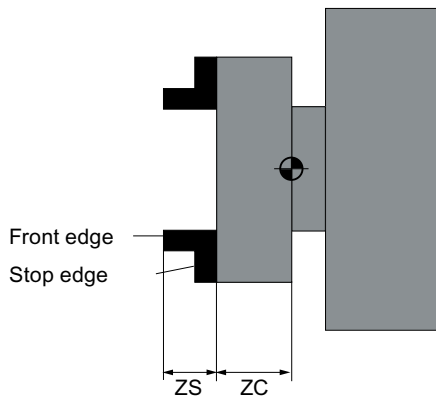

Dimensions, counter-spindle jaw type 1

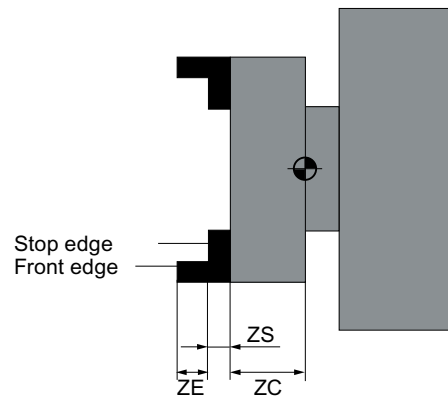

Dimensions, counter-spindle jaw type 2

Tailstock

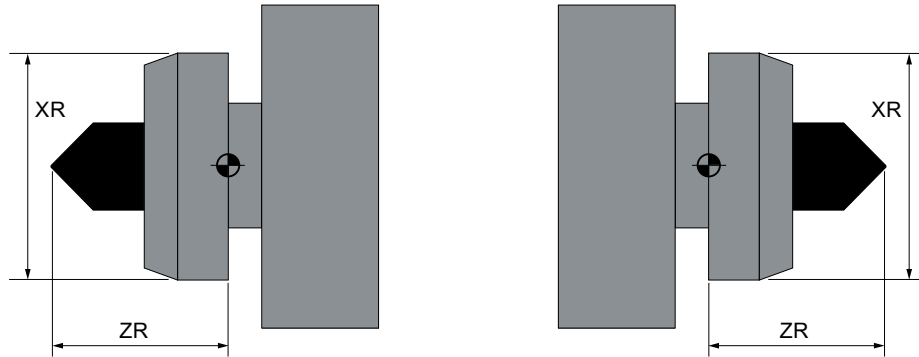

Dimensioning the main spindle tailstock

Dimensioning the counter-spindle tailstock

Procedure

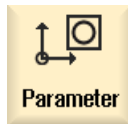

1. Select the "Parameter" operating area.



2. Press the "Setting data" and "Spindle chuck data" softkeys. The "Spindle Chuck Data" window opens.



3. Enter the desired parameter. The settings become active immediately.

See also

Machining with movable counterspindle (Page 639)

Parameter	Description	Unit
Main spindle		
	Dimensions of the forward edge or stop edge <ul style="list-style-type: none"> • Jaw type 1 • Jaw type 2 	
ZC1	Main spindle chuck dimensions (inc)	mm
ZS1	Main spindle stop dimensions (inc)	mm
ZE1	Jaw dimension, main spindle (inc) - only for "Jaw type 2"	mm
XR	Tailstock diameter - only for tailstock that has been set-up	mm
ZR	Tailstock length - only for tailstock that has been set-up	mm
Counter-spindle		

4.9 Monitoring axis and spindle data

Parameter	Description	Unit
	Dimensions of the forward edge or stop edge <ul style="list-style-type: none">• Jaw type 1• Jaw type 2	
ZC3	Chuck dimension, counter-spindle (inc) - only for a counter-spindle that has been set-up	mm
ZS3	Stop dimension, counter-spindle (inc) - only for a counter-spindle that has been set-up	mm
ZE3	Jaw dimension, counter-spindle (inc) - only for a counter-spindle that has been set-up and "Jaw type 2"	mm
XR	Tailstock diameter - only for tailstock that has been set-up	mm
ZR	Tailstock length - only for tailstock that has been set-up	mm

4.10 Displaying setting data lists

You can display lists with configured setting data.



Machine manufacturer

Please refer to the machine manufacturer's specifications.

Procedure



Parameter

1. Select the "Parameter" operating area.



Setting data

2. Press the "Setting data" and "Data lists" softkeys.
The "Setting Data Lists" window opens.



Data lists



Select data list

3. Press the "Select data list" softkey and in the "View" list, select the required list with setting data.

4.11 Handwheel assignment

You can traverse the axes in the machine coordinate system (Machine) or in the workpiece coordinate system (Work) via the handwheel.



Software option

You require the "Extended operator functions" option for the handwheel offset (only for 828D).

All axes are provided in the following order for handwheel assignment:

- **Geometry axes**
When traversing, the geometry axes taken into account the actual machine status (e.g. rotations, transformations). All channel machine axes, which are currently assigned to the geometry axis, are in this case simultaneously traversed.
- **Channel machine axes**
Channel machine axes are assigned to the particular channel. They can only be individually traversed, i.e. the actual machine state has no influence.
The also applies to channel machine axes, that are declared as geometry axes.



Machine manufacturer

Please refer to the machine manufacturer's specifications.

Procedure



1. Select the "Machine" operating area.



2. Press the <JOG>, <AUTO> or <MDI> key.



3. Press the menu forward key and the "Handwheel" softkey.
The "Handwheel" window appears.



A field for axis assignment will be offered for every connected handwheel.

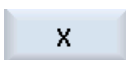

4. Position the cursor in the field next to the handwheel with which you wish to assign the axis (e.g. No. 1).
5. Press the corresponding softkey to select the desired axis (e.g. "X").

- OR



Open the "Axis" selection box using the <INSERT> key, navigate to the desired axis, and press the <INPUT> key.



Selecting an axis also activates the handwheel (e.g., "X" is assigned to handwheel no. 1 and is activated immediately).



6. Press the "Handwheel" softkey again.

- OR -



Press the "Back" softkey.

The "Handwheel" window closes.

Deactivate handwheel

1. Position the cursor on the handwheel whose assignment you wish to cancel (e.g. No. 1).



2. Press the softkey for the assigned axis again (e.g. "X").

- OR -



Open the "Axis" selection box using the <INSERT> key, navigate to the empty field, and press the <INPUT> key.



Clearing an axis selection also clears the handwheel selection (e.g., "X" is cleared for handwheel no. 1 and is no longer active).

4.12 MDA

In "MDI" mode (Manual Data Input mode), you can enter G-code commands or standard cycles block-by-block and immediately execute them for setting up the machine.

You have the option of loading an MDI program or a standard program with the standard cycles directly into the MDI buffer from the program manager; you can subsequently then edit it.

You can save programs, generated or modified in the MDI working window, in the program manager, e.g. in a directory specifically created for the purpose.



Software option

You require the "Extended operator functions" option to load and save MDI programs (for 828D).

4.12.1 Loading an MDA program from the Program Manager

Procedure



1. Select the "Machine" operating area.



2. Press the <MDI> key.

The MDI editor opens.



3. Press the "Load MDI" softkey.

A changeover is made into the Program Manager.

The "Load in MDI" window opens. It shows you a view of the program manager.



4. Position the cursor to the corresponding storage location, press the "Search" softkey and enter the required search term in the search dialog if you wish to search for a specific file.

Note: The place holders "*" (replaces any character string) and "?" (replaces any character) make it easier for you to perform a search.

5. Select the program that you would like to edit or execute in the MDI window.



6. Press the "OK" softkey.

The window closes and the program is ready for operation.

4.12.2 Saving an MDA program

Procedure



1. Select the "Machine" operating area.



2. Press the <MDI> key.

The MDI editor opens.

3. Create the MDI program by entering the G-code commands using the operator's keyboard.



4. Press the "Store MDI" softkey.

The "Save from MDI: Select storage location" window opens. It shows you a view of the program manager.

5. Select the drive to which you want to save the MDI program you created, and place the cursor on the directory in which the program is to be stored.

- OR -



Position the cursor to the required storage location, press the "Search" softkey and enter the required search term in the search dialog if you wish to search for a specific directory or subdirectory.

Note: The place holders "*" (replaces any character string) and "?" (replaces any character) make it easier for you to perform a search.

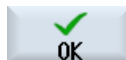

6. Press the "OK" softkey.

When you place the cursor on a folder, a window opens which prompts you to assign a name.

- OR -

When you place the cursor on a program, you are asked whether the file should be overwritten.

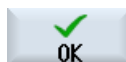

7. Enter the name for the rendered program and press the "OK" softkey. The program will be saved under the specified name in the selected directory.

4.12.3 Editing/executing a MDI program

Procedure



1. Select the "Machine" operating area.



2. Press the <MDI> key.
The MDI editor opens.

3. Enter the desired G-code commands using the operator's keyboard.
- OR -
Enter a standard cycle, e.g. CYCLE62 ().

Editing G-code commands/program blocks

4. Edit G-code commands directly in the "MDI" window.
- OR -



Select the required program block (e.g. CYCLE62) and press the <cursor right> key, enter the required value and press "OK".



When editing a cycle, either the help screen or the graphic view can be displayed.



5. Press the <CYCLE START> key.

The control executes the input blocks.

When executing G-code commands and standard cycles, you have the option of controlling the sequence as follows:

- Executing the program block-by-block
- Testing the program
Settings under program control
- Setting the test-run feedrate
Settings under program control

See also

Program control (Page 169)

4.12.4 Deleting an MDA program

Precondition

The MDA editor contains a program that you created in the MDI window or loaded from the program manager.

Procedure



Press the "Delete blocks" softkey.

The program blocks displayed in the program window are deleted.

Working in manual mode

5.1 General

Always use "JOG" mode when you want to set up the machine for the execution of a program or to carry out simple traversing movements on the machine:

- Synchronize the measuring system of the controller with the machine (reference point approach)
- Set up the machine, i.e. activate manually-controlled motions on the machine using the keys and handwheels provided on the machine control panel.
- You can activate manually controlled motions on the machine using the keys and handwheels provided on the machine control panel while a part program is interrupted.

5.2 Selecting a tool and spindle

5.2.1 T,S,M window

For the preparatory actions in manual mode, tool selection and spindle control are both performed centrally in a screen form.

In addition to the main spindle (S1), there is another tool spindle (S2) for powered tools.

Your turning machine can also be equipped with a counter-spindle (S3).

In manual mode, you can select a tool on the basis of either its name or its revolver location number. If you enter a number, a search is performed for a name first, followed by a location number. This means that if you enter "5", for example, and no tool with the name "5" exists, the tool is selected from location number "5".

Note



Using the revolver location number, therefore, you can swing around an empty space into the machining position and then comfortably install a new tool.



Machine manufacturer

Please refer to the machine manufacturer's specifications.

Parameter	Meaning	Unit
T	Input of the tool (name or location number) You can select a tool from the tool list using the "Select tool" softkey.	
D	Cutting edge number of the tool (1 - 9)	
ST	Sister tool (1 - 99 for replacement tool strategy)	
Spindle	Spindle selection, identification with spindle number	
Spindle M function	Spindle off: Spindle is stopped	
	CCW rotation: Spindle rotates counterclockwise	
	CW rotation: Spindle rotates clockwise	
	Spindle positioning: Spindle is moved to the desired position.	
Other M functions	Input of machine functions Refer to the machine manufacturer's table for the correlation between the meaning and number of the function.	
Work offset G	Selection of the work offset (basic reference, G54 - 57) You can select work offsets from the tool list of settable work offsets via the "Work offset" softkey.	
Dimension unit	Selecting the measurement unit The setting made here has an effect on the programming.	inch mm

Parameter	Meaning	Unit
Machining plane 	Selection of the machining plane (G17(XY), G18 (ZX), G19 (YZ))	
Gear stage 	Specification of the gear stage (auto, I - V)	
Stop position	Entering the spindle position	Degrees

Note**Spindle positioning**

You can use this function to position the spindle at a specific angle, e.g. during a tool change.

- A stationary spindle is positioned via the shortest possible route.
- A rotating spindle is positioned as it continues to turn in the same direction.

5.2.2 Selecting a tool

Procedure



1. Select the "JOG" operating mode.



2. Press the "T, S, M" softkey.



3. Select as to whether you wish that the tool is identified using a name or the location number.

4. Enter the name or the number of the tool T in the entry field.
- OR -



Press the "Select tool" softkey.
The tool selection window is opened.

Place the cursor on the desired tool and press the "OK" softkey.

The tool is transferred to the "T, S, M... window" and displayed in the field of tool parameter "T".



5. Select the tool cutting edge D or enter the number directly in the field.



6. Select the sister tool ST or enter the number directly in field "ST".

5.2 Selecting a tool and spindle



7. Press the <CYCLE START> key.

The tool is automatically swung into the machining position and the name of the tool displayed in the tool status bar.

5.2.3 Starting and stopping the spindle manually

Procedure



1. Select the "T,S,M" softkey in the "JOG" mode.



2. Select the desired spindle (e.g. S1) and enter the desired spindle speed or cutting speed in the right-hand entry field.



3. If the machine has a gearbox for the spindle, set the gearing step.
4. Select a spindle direction of rotation (clockwise or counterclockwise) in the "Spindle M function" field.



5. Press the <CYCLE START> key.
The spindle rotates.



6. Select the "Stop" setting in the "Spindle M function" field.



Press the <CYCLE START> key.
The spindle stops.

Note

Changing the spindle speed

If you enter the speed in the "Spindle" field while the spindle is rotating, the new speed is applied.

5.2.4 Positioning the spindle

Procedure



1. Select the "T,S,M" softkey in the "JOG" mode.



2. Select the "Stop Pos." setting in the "Spindle M function" field.
The "Stop Pos." entry field appears.
3. Enter the desired spindle stop position.
The spindle position is specified in degrees.
4. Press the <CYCLE START> key.



The spindle is moved to the desired position.

Note

You can use this function to position the spindle at a specific angle, e.g. during a tool change.

- A stationary spindle is positioned via the shortest possible route.
 - A rotating spindle is positioned as it continues to turn in the same direction.
-

5.3 Traversing axes

You can traverse the axes in manual mode via the Increment or Axis keys or handwheels.

During a traverse initiated from the keyboard, the selected axis moves at the programmed setup feedrate. During an incremental traverse, the selected axis traverses a specified increment.

Set the default feedrate

Specify the feedrate to be used for axis traversal in the set-up, in the "Settings for Manual Operation" window.

5.3.1 Traverse axes by a defined increment

You can traverse the axes in manual mode via the Increment and Axis keys or handwheels.

Procedure



1. Select the "Machine" operating area.



2. Press the <JOG> key.



3. Press keys 1, 10, etc. up to 10000 in order to move the axis in a defined increment.

The numbers on the keys indicate the traverse path in micrometers or microinches.



Example: Press the "100" button for a desired increment of 100 μm (= 0.1 mm).



4. Select the axis to be traversed.



5. Press the <+> or <-> key.

Each time you press the key the selected axis is traversed by the defined increment.



Feedrate and rapid traverse override switches can be operative.

Note

When the controller is switched on, the axes can be traversed right up to the limits of the machine as the reference points have not yet been approached and the axes referenced. Emergency limit switches might be triggered as a result.

The software limit switches and the working area limitation are not yet operative!

The feed enable signal must be set.

**Machine manufacturer**

Please refer to the machine manufacturer's specifications.

5.3.2 Traversing axes by a variable increment

Procedure



1. Select the "Machine" operating area.



2. Press the <JOG> key.



3. Press the "Settings" softkey.
The "Settings for Manual Operation" window is opened.
4. Enter the desired value for the "Variable increment" parameter.
Example: Enter 500 for a desired increment of 500 μm (0.5 mm).



5. Press the <Inc VAR> key.



6. Select the axis to be traversed.
7. Press the <+> or <-> key.
Each time you press the key the selected axis is traversed by the set increment.



Feedrate and rapid traverse override switches can be operative.

5.4 Positioning axes

In order to implement simple machining sequences, you can traverse the axes to certain positions in manual mode.

The feedrate / rapid traverse override is active during traversing.

Procedure



1. If required, select a tool.
2. Select the "JOG" operating mode.
3. Press the "Positions" softkey.
4. Enter the target position or target angle for the axis or axes to be traversed.
5. Specify the desired value for the feedrate F.
- OR -
Press the "Rapid traverse" softkey.
The rapid traverse is displayed in field "F".
6. Press the <CYCLE START> key.
The axis is traversed to the specified target position.

If target positions were specified for several axes, the axes are traversed simultaneously.

5.5 Manual retraction

In the following cases, the "Retract" function allows drilling tools to be retracted in the tool direction in the JOG mode:

- After interrupting a thread tapping operation (G33/331/G332),
- After interrupting machining operations using drilling tools (tools 200 to 299) as a result of power failure or a RESET at the machine control panel.

The tool and/or the workpiece remain undamaged.

Retraction is especially useful when the coordinate system is swiveled, i.e. the infeed axis is not in the vertical position.

Note

Tapping

In the case of tapping, the form fit between the tap and the workpiece is taken into account and the spindle moved according to the thread.

Use the Z axis as well as the spindle when retracting from threads.

The machine OEM sets up the "Retract" function.



Machine manufacturer

Please observe the information provided by the machine manufacturer.

Procedure



1. The power feed to the machine is interrupted.
- OR -
<RESET> interrupts an active part program.
2. After a power supply interruption, switch on the controller.
3. Select the JOG operating mode.
4. Press the Menu forward key.
5. Press the "Retract" softkey.
The "Retract Tool" window opens.
The softkey is available only when an active tool and retraction data are present.
6. Select the "WCS" coordinate system on the machine control panel.

5.5 Manual retraction



7. Use the traversing keys (e.g. Z +) to traverse the tool from the workpiece according to the retraction axis displayed in the "Retract Tool" window.



8. Press the "Retract" softkey again when the tool is at the desired position.

5.6 Simple stock removal of workpiece

Some blanks have a smooth or even surface. For example, you can use the stock removal cycle to turn the face surface of the workpiece before machining actually takes place.

If you want to bore out a collet using the stock removal cycle, you can program an undercut (XF2) in the corner.

CAUTION

Risk of collision

The tool moves along a direct path to the starting point of the stock removal. First move the tool to a safe position in order to avoid collisions during the approach.

Retraction plane / safety clearance

The retraction plane and safety clearance are set via the machine data \$SCS_MAJOG_SAFETY_CLEARANCE or \$SCS_MAJOG_RELEASE_PLANE.



Machine manufacturer

Please refer to the machine manufacturer's specifications.

Direction of spindle rotation

If the "ShopMill/ShopTurn" option is activated, the direction of spindle rotation is taken from the tool parameters entered in the tool list.

If the "ShopMill/ShopTurn" option is not set, select the direction of spindle rotation in the input screen.

Note

You cannot use the "Repos" function during simple stock removal.

Requirement

To carry out simple stock removal of a workpiece in manual mode, a measured tool must be in the machining position.

Procedure



1. Press the "Machine" operating area key



2. Press the <JOG> key.

5.6 Simple stock removal of workpiece



3. Press the "Stock removal" softkey.



4. Enter desired values for the parameters.

5. Press the "OK" softkey.

















The parameter screen is closed.



6. Press the <CYCLE START> key.

The "Stock removal" cycle is started.

You can return to the parameter screen form at any time to check and correct the inputs.

Parameters	Description	Unit
T	Tool name	
D	Cutting edge number	
F	Feedrate	mm/rev
S / V 	Spindle speed or constant cutting rate	rpm m/min
Spindle M function	Direction of spindle rotation (only when ShopTurn is not active) <ul style="list-style-type: none">   	
Machining 	<ul style="list-style-type: none">  (roughing)  (finishing) 	
Position 	Machining position    	
Machining direction 	<ul style="list-style-type: none"> Face Longitudinal 	
X0	Reference point \emptyset (abs)	mm
Z0	Reference point (abs)	mm
X1 	End point X \emptyset (abs) or end point X in relation to X0 (inc)	mm
Z1 	End point Z (abs) or end point Z in relation to X0 (inc)	mm
FS1...FS3 or R1...R3 	Chamfer width (FS1...FS3) or rounding radius (R1...R3)	mm
XF2 	Undercut (alternative to FS2 or R2)	mm
D	Infeed depth (inc) – (for roughing only)	mm

Parameters	Description	Unit
UX	Final machining allowance in X direction (inc) – (for roughing only)	mm
UZ	Final machining allowance in Z direction (inc) – (for roughing only)	mm

See also

Tool, offset value, feedrate and spindle speed (T, D, F, S, V) (Page 300)

5.7 Thread synchronizing

If you wish to re-machine a thread, it may be necessary to synchronize the spindle to the existing thread turn. By re-clamping the blank, an angular offset can occur in the thread.

Constraint

Thread synchronizing is not possible if a tool carrier is used (B axis).

Note

Activating/deactivating thread synchronization

Active thread synchronization has an effect on all the following "Thread turning" machining steps.

Thread synchronization remains effective without deactivation even after the machining has been shut down.

Requirement

The spindle is stationary.

One threading tool is active.

Procedure



1. Select the "JOG" operating mode.



2. Press the menu forward key and the "Thread synchr." softkey.



3. Thread the thread cutting tool into the thread turn as shown in the help screen.

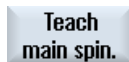

4. Press the "Teach-in main spindle" softkey if you are working at the main spindle.

- OR -



Press the "Teach-in counterspindle" softkey if you are working at the counterspindle.

Note:

The thread synchronization is activated by teaching in a spindle. In this case, the synchronizing positions of axes X and Z and the synchronizing angle of spindle (Sn) are saved in the Machine and displayed in the screen form.

The selection boxes for main spindle and counterspindle indicate whether thread synchronization is active for the particular spindle (yes = active / no = not active).

5. Now carry out the "thread turning" machining step.
6. For the main spindle or counterspindle, select the "no" entry to deactivate thread synchronization.



5.8 Default settings for manual mode

Specify the configurations for the manual mode in the "Settings for manual operation" window.

Default settings

Settings	Meaning
Type of feedrate	Here, you select the type of feedrate.
	<ul style="list-style-type: none">• G94: Axis feedrate/linear feedrate• G95: Revolutional feedrate
Setup feedrate G94	Enter the desired feedrate in mm/min.
Setup feedrate G95	Enter the desired feedrate in mm/rev.
Variable increment	For variable increments, enter the desired increment when traversing axes.
Spindle speed	Here, enter the desired spindle speed in rpm.

Procedure



1. Select the "Machine" operating area.



2. Press the <JOG> key.



3. Press the menu forward key and the "Settings" softkey.
The "Settings for manual operation" window is opened.



See also

Switching the unit of measurement (Page 96)

Machining the workpiece

6.1 Starting and stopping machining

During execution of a program, the workpiece is machined in accordance with the programming on the machine. After the program is started in automatic mode, workpiece machining is performed automatically.

Preconditions

The following requirements must be met before executing a program:

- The measuring system of the controller is referenced with the machine.
- The necessary tool offsets and work offsets have been entered.
- The necessary safety interlocks implemented by the machine manufacturer are activated.

General sequence



1. Use the Program manager to select the desired program.



2. Select under "NC", "Local. Drive", "USB" or set-up network drives the desired program.



3. Press the "Select" softkey.
The program is selected for execution and automatically switched to the "Machine" operating area.



4. Press the <CYCLE START> key.
The program is started and executed.

Note

Starting the program in any operating area

If the control system is in the "AUTO" mode, you can also start the selected program when you are in any operating area.

6.1 Starting and stopping machining

Stopping machining



Press the <CYCLE STOP> key.

Machining stops immediately, individual blocks do not finish execution. At the next start, execution is resumed at the same location where it stopped.

Canceling machining



Press the <RESET> key.

Execution of the program is interrupted. On the next start, machining will start from the beginning.



Machine manufacturer

Please observe the information provided by the machine manufacturer.

6.2 Selecting a program

Procedure



1. Select the "Program Manager" operating area.
The directory overview is opened.



2. Select the location where the program is archived (e.g. "NC")
3. Place the cursor on the directory containing the program that you want to select.



4. Press the <INPUT> key.

- OR -

Press the <Right cursor> key.

The directory contents are displayed.



5. Place the cursor on the desired program.

6. Press the "Select" softkey.

When the program has been successfully selected, an automatic change-over to the "Machine" operating area occurs.

6.3 Executing a trail program run

When testing a program, you can select that the system can interrupt the machining of the workpiece after each program block, which triggers a movement or auxiliary function on the machine. In this way, you can control the machining result block-by-block during the initial execution of a program on the machine.

Note

Settings for the automatic mode

Rapid traverse reduction and dry run feed rate are available to run-in or to test a program.

Move by single block

In "Program control" you may select from among several types of block processing:

SB mode	Scope
SB1 Single block, coarse	Machining stops after every machine block (except for cycles).
SB2 Data block	Machining stops after every block, i.e. also for data blocks (except for cycles)
SB3 Single block, fine	Machining stops after every machine block (also in cycles)

Precondition

A program must be selected for execution in "AUTO" or "MDA" mode.

Procedure



1. Press the "Prog. ctrl." softkey and select the desired variant in the "SBL" field.



2. Press the <SINGLE BLOCK> key.



3. Press the <CYCLE START> key.
 Depending on the execution variant, the first block will be executed. Then the machining stops.
 In the channel status line, the text "Stop: Block in single block ended" appears.



4. Press the <CYCLE START> key.
 Depending on the mode, the program will continue executing until the next stop.



5. Press the <SINGLE BLOCK> key again, if the machining is not supposed to run block-by-block.

The key is deselected again.



If you now press the <CYCLE START> key again, the program is executed to the end without interruption.

6.4 Displaying the current program block

6.4.1 Current block display

The window of the current block display shows the program blocks currently being executed.

Display of current program

The following information is displayed in the running program:

- The workpiece name or program name is entered in the header line.
- The program block which is just being processed appears colored.

Display of the machining times



If you set that the machining times are to be recorded in the settings for automatic mode, the measured times are shown at the end of the line as follows:

Display	Meaning
Light green background ⌚ 17.18	Measured machining time of the program block (automatic mode)
Green background ⌚ 19.47	Measured machining time of the program block (automatic mode)
Light blue background ⌚ 17.31	Estimated machining time of the program block (simulation)
Blue background ⌚ 19.57	Estimated machining time of the program block (simulation)
Yellow background ⌚ 4.53	Wait time (automatic mode or simulation)

Highlighting of selected G code commands or keywords

In the program editor settings, you can specify whether selected G code commands are to be highlighted in color. The following colors are used as standard:

Display	Meaning
Blue font M30	D, S, F, T, M and H functions
Red font G0	"G0" motion command
Green font G1	"G1" motion command

Display	Meaning
Blue-green font 	"G2" or "G3" motion command
Gray font 	Comment

Machine manufacturer



You can define further highlight colors in the "sleditorwidget.ini" configuration file. Please refer to the machine manufacturer's instructions.

Editing a program directly

In the Reset state, you can edit the current program directly.



1. Press the <INSERT> key.

2. Place the cursor at the relevant position and edit the program block.
Direct editing is only possible for G code blocks in the NC memory, not for external execution.



3. Press the <INSERT> key to exit the program and the edit mode again.

See also

Setting for automatic mode (Page 227)

6.4.2 Displaying a basic block

If you want precise information about axis positions and important G functions during testing or program execution, you can call up the basic block display. This is how you check, when using cycles, for example, whether the machine is actually traversing.

Positions programmed by means of variables or R parameters are resolved in the basic block display and replaced by the variable value.

You can use the basic block display both in test mode and when machining the workpiece on the machine. All G code commands that initiate a function on the machine are displayed in the "Basic Blocks" window for the currently active program block:

- Absolute axis positions
- G functions for the first G group
- Other modal G functions

6.4 Displaying the current program block

- Other programmed addresses
- M functions



Machine manufacturer

Please observe the information provided by the machine manufacturer.

Procedure



1. A program is selected for execution and has been opened in the "Machine" operating area.
2. Press the "Basic blocks" softkey.
The "Basic Blocks" window opens.
3. Press the <SINGLE BLOCK> key if you wish to execute the program block by block.
4. Press the <CYCLE START> key to start the program execution.
The axis positions to be approached, modal G functions, etc., are displayed in the "Basic Blocks" window for the currently active program block.
5. Press the "Basic blocks" softkey once again to hide the window again.

6.4.3 Display program level

You can display the current program level during the execution of a large program with several subprograms.

Several program run throughs

If you have programmed several program run throughs, i.e. subprograms are run through several times one after the other by specifying the additional parameter P, then during processing, the program runs still to be executed are displayed in the "Program Levels" window.

Program example

N10 subprogram P25

If, in at least one program level, a program is run through several times, a horizontal scroll bar is displayed that allows the run through counter P to be viewed in the righthand window section. The scroll bar disappears if multiple run-through is no longer applicable.

Display of program level

The following information will be displayed:

- Level number
- Program name

- Block number, or line number
- Remain program run throughs (only for several program run throughs)

Precondition

A program must be selected for execution in "AUTO" mode.

Procedure



Press the "Program levels" softkey.
The "Program levels" window appears.

6.5 Correcting a program

As soon as a syntax error in the part program is detected by the controller, program execution is interrupted and the syntax error is displayed in the alarm line.

Correction options

Depending on the state of the control system, you have various options of correcting the program.

- Stop state
Only change lines that have not been executed
- Reset status
Change all lines

Note

The "program correction" function is also available for execute from external; however, when making program changes, the NC channel must be brought into the reset state.

Precondition

A program must be selected for execution in "AUTO" mode.

Procedure



1. The program to be corrected is in the Stop or Reset mode.
2. Press the "Prog. corr." softkey.

The program is opened in the editor.

The program preprocessing and the current block are displayed. The current block is also updated in the running program, but not the displayed program section, i.e. the current block moves out of the displayed program section.

If a subprogram is executed, it is not opened automatically.



3. Make the necessary corrections.
4. Press the "NC Execute" softkey.

The system switches back to the "Machine" operating area and selects "AUTO" mode.



5. Press the "CYCLE START" key to resume program execution.

Note

When you exit the editor using the "Close" softkey, you return to the "Program manager" operating area.

6.6 Repositioning axes

After a program interruption in the automatic mode (e.g. after a tool breaks), you can move the tool away from the contour in manual mode.

The coordinates of the interrupt position will be saved. The distances traversed in manual mode are displayed in the actual value window. This path difference is called "Repos-offset".

Resuming program execution

Using the "Repos" function, you return the tool to the contour in order to continue executing the program.

The interrupt position is not passed as it is blocked by the control system.

The feedrate/rapid traverse override is in effect.

NOTICE

Risk of collision

When repositioning, the axes move with the programmed feedrate and linear interpolation, i.e. in a straight line from the current position to the interrupt point. Therefore, you must first move the axes to a safe position in order to avoid collisions.

If you do not use the "Repos" function and subsequently move the axes in manual mode after a program interrupt, the control automatically moves the axes during the switch to automatic mode and the subsequent start of the machining process in a straight line back to the point of interruption.

Precondition

The following prerequisites must be met when repositioning the axes:

- The program execution was interrupted using <CYCLE STOP>.
- The axes were moved from the interrupt point to another position in manual mode.

Procedure



1. Press the <REPOS> key.



2. Select the axes to be traversed one after the other.



3. Press the <+> or <-> key for the relevant direction.
The axes are moved to the interrupt position.



6.7 Starting machining at a specific point

6.7.1 Use block search

If you only want to perform a certain section of a program on the machine, then you have to start the program from the beginning. You can start the program from a specified program block.

Applications

- Stopping or interrupting program execution
- Specifying a target position, e.g. during post processing

Determining a search target

- User-friendly search target definition (search positions)
 - Direct specification of the search target by positioning the cursor in the selected program (main program)
Note:
During the block search it must be ensured that the correct tool is in the working position before starting the execution of the program.
ShopTurn has automated this process. Any necessary tool change is automatically executed with ShopTurn program steps with this block search variant.
Please observe the corresponding information provided by the machine manufacturer.
 - Search target via text search
 - The search target is the interruption point (main program and subprogram)
The function is only available if there is an interruption point. After a program interruption (CYCLE STOP, RESET or power off), the controller saves the coordinates of the interruption point.
 - The search target is the higher program level of the interruption point (main program and subprogram)
A change of planes is only possible if an interruption point located in a subprogram is selected. It is thus possible to switch to the main program level and back to the level of the interruption point.
- Search pointer
 - Direct entry of the program path

Note

You can search for a specific point in subprograms with the search pointer if there is no interruption point.



Software option

You require the "Extended operator functions" option for the "Search pointer" function (only for 828D).

Cascaded search

You can start another search from the "Search target found" state. Each time a search target is found, it is possible to continue cascading arbitrarily.

Note

Another cascaded block search can be started from the stopped program execution only if the search target has been found.

References

Function Manual Basic Functions; Block Search

Preconditions

- You have selected the desired program.
- The controller is in the reset state.
- The desired search mode is selected.

NOTICE
<p>Risk of collision</p> <p>Pay attention to a collision-free start position and appropriate active tools and other technological values.</p> <p>If necessary, manually approach a collision-free start position. Select the target block considering the selected block search variant.</p>

Toggling between search pointer and search positions



Press the "Search pointer" softkey again to exit the "Search Pointer" window and return to the program window to define search positions.

- OR -



Press the "Back" softkey.

You have now exited the block search function.

See also

Selecting a program (Page 151)

6.7.2 Continuing program from search target

To continue the program at the desired position, press the <CYCLE START> key twice.

- The first CYCLE START outputs the auxiliary functions collected during the search. The program is then in the Stop state.
- Before the second CYCLE START, you can use the "Overstore" function to create states that are required, but not yet available, for the further program execution. By changing to the JOG REPOS mode, you can also manually traverse the tool from the current position to the setpoint position, if the setpoint position is not to be automatically approached after the program start

6.7.3 Simple search target definition

Requirement

The program is selected and the controller is in Reset mode.

Procedure



1. Press the "Block search" softkey.

2. Place the cursor on a particular program block.

- OR -



Press the "Find text" softkey, select the search direction, enter the search text and confirm with "OK".



3. Press the "Start search" softkey.

The search starts. Your specified search mode will be taken into account.

The current block will be displayed in the "Program" window as soon as the target is found.



4. If the located target (for example, when searching via text) does not correspond to the program block, press the "Start search" softkey again until you find your target.

Press the <CYCLE START> key twice.

Processing is continued from the defined position.

6.7.4 Defining an interruption point as search target

Requirement

A program was selected in "AUTO" mode and interrupted during execution through CYCLE STOP or RESET.



Software option

You require the "Extended operator functions" option (only for 828D).

Procedure



1. Press the "Block search" softkey.



2. Press the "Interrupt point" softkey.
The interruption point is loaded.



3. If the "Higher level" and "Lower level" softkeys are available, use these to change the program level.



4. Press the "Start search" softkey.

The search starts. Your specified search mode will be taken into account.
The search screen closes.

The current block will be displayed in the "Program" window as soon as the target is found.



5. Press the <CYCLE START> key twice.

The execution will continue from the interruption point.

6.7.5 Entering the search target via search pointer

Enter the program point which you would like to proceed to in the "Search Pointer" window.



Software option

You require the "Extended operator functions" option for the "Search pointer" function (only for 828D).

Requirement

The program is selected and the controller is in the reset state.

Screen form

Each line represents one program level. The actual number of levels in the program depends on the nesting depth of the program.

Level 1 always corresponds to the main program and all other levels correspond to subprograms.

You must enter the target in the line of the window corresponding to the program level in which the target is located.

For example, if the target is located in the subprogram called directly from the main program, you must enter the target in program level 2.

The specified target must always be unambiguous. This means, for example, that if the subprogram is called in the main program in two different places, you must also specify a target in program level 1 (main program).

Procedure



1. Press the "Block search" softkey.



2. Press the "Search pointer" softkey.

3. Enter the full path of the program as well as the subprograms, if required, in the input fields.



4. Press the "Start search" softkey.

The search starts. Your specified search mode will be taken into account. The Search window closes. The current block will be displayed in the "Program" window as soon as the target is found.



5. Press the <CYCLE START> key twice.

Processing is continued from the defined location.

Note

Interruption point

You can load the interruption point in search pointer mode.

6.7.6 Parameters for block search in the search pointer

Parameter	Meaning
Number of program level	
Program:	The name of the main program is automatically entered
Ext:	File extension

Parameter	Meaning
P:	Number of subprogram repetitions If a subprogram is performed several times, you can enter the number of the pass here at which processing is to be continued
Line:	Is automatically filled for an interruption point
Type	" " search target is ignored on this level N no. Block number Label Jump label Text string Subprg. Subprogram call Line Line number
Search target	Point in the program at which machining is to start

6.7.7 Block search mode

Set the desired search variant in the "Search Mode" window.

The set mode is retained when the control is shut down. When you activate the "Search" function after restarting the control, the current search mode is displayed in the title row.

Search variants

Block search mode	Meaning
With calculation - without approach	In order to be able to approach a target position in any circumstance (e.g. tool change position). The end position of the target block or the next programmed position is approached using the type of interpolation valid in the target block. Only the axes programmed in the target block are moved. Note: If machine data 11450.1=1 is set, the rotary axes of the active swivel data record are pre-positioned after the block search.
With calculation - with approach	It is used to be able to approach the contour in any circumstance. The end position of the block prior to the target block is found with <CYCLE START>. The program runs in the same way as in normal program processing. Note: This block search mode should only be used in exceptional cases if machining was directly interrupted at the workpiece - and machining is to directly continue at the workpiece again. For a ShopTurn program, this block search mode can only be performed on G code blocks. If possible, the block search mode "with calculation - without approach" should be used.

6.7 Starting machining at a specific point

Block search mode	Meaning
With calculation - skip extcall	This is used to speed-up a search with calculation when using EXTCALL programs: EXTCALL programs are not taken into account. Notice: Important information, e.g. modal functions, which are located in the EXTCALL program, are not taken into account. In this case, after the search target has been found, the program is not able to be executed. Such information should be programmed in the main program.
Without calculation	For a quick search in the main program. Calculations will not be performed during the block search, i.e. the calculation is skipped up to the target block. All settings required for execution have to be programmed from the target block (e.g. feedrate, spindle speed, etc.).
With program test	Multi-channel block search with calculation (SERUPRO). All blocks are calculated during the block search. Absolutely no axis motion is executed, however, all auxiliary functions are output. The NC starts the selected program in the program test mode. If the NC reaches the specified target block in the actual channel, it stops at the beginning of the target block and deselects program test mode again. After continuing the program with NC start (after REPOS motion) the auxiliary functions of the target block are output. For single-channel systems, the coordination is supported with events running in parallel, e.g. synchronized actions. Note The search speed depends on MD settings.

Note

Search mode for ShopTurn programs

- The search variant for the ShopTurn machining step programs can be specified via MD 51024. This applies only to the ShopTurn single-channel view.



Machine manufacturer

Please refer to the machine manufacturer's specifications.

References

For additional information, please refer to the following documentation:

SINUMERIK Operate (IM9) / SINUMERIK 840D sl Commissioning Manual

Procedure

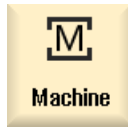

1. Select the "Machine" operating area.



2. Press the <AUTO> key.



3. Press the "Block search" and "Block search mode" softkeys.
The "Search Mode" window opens.



6.7.8 Block search for position pattern for ShopTurn programs

For ShopTurn programs, you have the option of carrying out a block search for a position pattern. You define the technology with which you wish to start, as well as the number of the starting hole.



Software option

You require the "ShopMill/ShopTurn" option for the block search for ShopTurn machining step programs.



Machine manufacturer

Please refer to the machine manufacturer's instructions.

Procedure



1. The required ShopTurn program is in the block display.
Press the "Block search" softkey.



2. Position the cursor to the position block.
3. Press the "Start search" softkey.

The "Search" window opens.

All of the technologies used in the program are listed.



4. Select the desired technology and press "OK".
The selected technology is displayed in the "Search" window.

6.7 Starting machining at a specific point



5. Enter the number of the starting hole and press "OK".
Program execution starts with the specified technology at the specified starting hole, and navigates you to all of the positions of this position pattern and all following position patterns.

Note

If you have hidden certain positions, then only the displayed positions count for the number of the starting hole.

6.8 Controlling the program run

6.8.1 Program control

You can change the program sequence in the "AUTO" and "MDA" modes.

Abbreviation/program control	Mode of operation
PRT No axis motion	The program is started and executed with auxiliary function outputs and dwell times. In this mode, the axes are not traversed. The programmed axis positions and the auxiliary function outputs are controlled this way. Note: You can activate program execution without any axis motion using the "Dry run feedrate".
DRY Dry run feedrate	The traversing velocities programmed in conjunction with G1, G2, G3, CIP and CT are replaced by a defined dry run feedrate. The dry run feedrate also applies instead of the programmed revolutional feedrate. Caution: Do not machine any workpieces when "Dry run feedrate" is active because the altered feedrates might cause the permissible tool cutting rates to be exceeded and the workpiece or machine tool could be damaged.
RG0 Reduced rapid traverse	In the rapid traverse mode, the traversing speed of the axes is reduced to the percentage value entered in RG0. Note: You define the reduced rapid traverse in the settings for automatic operation.
M01 Programmed stop 1	The processing of the program stops at every block in which supplementary function M01 is programmed. In this way you can check the already obtained result during the processing of a workpiece. Note: In order to continue executing the program, press the <CYCLE START> key again.
Programmed stop 2 (e.g. M101)	The processing of the program stops at every block in which the "Cycle end" is programmed (e.g. with M101). Note: In order to continue executing the program, press the <CYCLE START> key again. Note: The display can be changed. Please refer to the machine manufacturer's specifications.
DRF Handwheel offset	Enables an additional incremental work offset while processing in automatic mode with an electronic handwheel. This function can be used to compensate for tool wear within a programmed block. Note: You require the "Extended operator functions" option to use the handwheel offset (for 828D).
SB	Individual blocks are configured as follows. <ul style="list-style-type: none"> • Single block, coarse: The program stops only after blocks which perform a machine function. • Data block: The program stops after each block. • Single block, fine: The program also stops only after blocks which perform a machine function in cycles. Select the desired setting using the <SELECT> key.
SKP	Skip blocks are skipped during machining.
GCC	When executing a jobshop program, it is converted into a G-code program.
MRD	In the program, the measurement results screen display is activated while machining.

Activating program control

You can control the program sequence however you wish by selecting and clearing the relevant checkboxes.

Display / response of active program controls

If program control is activated, the abbreviation of the corresponding function appears in the status display as feedback response.

Procedure



1. Select the "Machine" operating area.



2. Press the <AUTO> or <MDI> key.



3. Press the "Prog. ctrl." softkey.
The "Program Control" window opens.

6.8.2 Skip blocks

You can skip program blocks that are not to be executed every time the program runs.

The skip blocks are identified by placing a "/" (forward slash) or "/x (x = number of skip level) character in front of the block number. You have the option of hiding several block sequences.

The statements in the skipped blocks are not executed. The program continues with the next block, which is not skipped.

The number of skip levels that can be used depends on a machine datum.



Machine manufacturer

Please observe the information provided by the machine manufacturer.



Software option

In order to have more than two skip levels, for 828D you require the "Extended operator functions" option.

Skip levels, activate

Select the corresponding checkbox to activate the desired skip level.

Note

The "Program Control - Skip Blocks" window is only available when more than one skip level is set up.

6.9 Overstore

With overstore, you have the option of executing technological parameters (for example, auxiliary functions, axis feed, spindle speed, programmable instructions, etc.) before the program is actually started. The program instructions act as if they are located in a normal part program. These program instructions are, however, only valid for one program run. The part program is not permanently changed. When next started, the program will be executed as originally programmed.

After a block search, the machine can be brought into another state with overstore (e.g. M function, tool, feed, speed, axis positions etc.), in which the normal part program can be successfully continued.



Software option

You require the "Extended operator functions" option for the overstore function (for 828D).

Precondition

The program to be corrected is in the Stop or Reset mode.

Procedure



1. Open the program in the "AUTO" mode.



2. Press the "Overstore" softkey.
The "Overstore" window opens.
3. Enter the required data and NC block.
4. Press the <CYCLE START> key.



The blocks you have entered are stored. You can observe execution in the "Overstore" window.
After the entered blocks have been executed, you can append blocks again.

You cannot change the operating mode while you are in overstore mode.



5. Press the "Back" softkey.
The "Overstore" window closes.



6. Press the <CYCLE START> key again.
The program selected before overstore continues to run.

Note

Block-by-block execution

The <SINGLE BLOCK> key is also active in the overstore mode. If several blocks are entered in the overstore buffer, then these are executed block-by-block after each NC start

Deleting blocks



Press the "Delete blocks" softkey to delete program blocks you have entered.

6.10 Editing a program

With the editor, you are able to render, supplement, or change part programs.

Note

Maximum block length

The maximum block length is 512 characters.

Calling the editor

- The editor is started via the "Program correction" softkey in the "Machine" operating area. You can directly change the program by pressing the <INSERT> key.
 - The editor is called via the "Open" softkey as well as with the <INPUT> or <Cursor right> key in the "Program manager" operating area.
 - The editor opens in the "Program" operating area with the last executed part program, if this was not explicitly exited via the "Close" softkey.
-

Note

- Please note that the changes to programs saved in the NC memory take immediate effect.
 - If you are editing on a local drive or external drives, you can also exit the editor without saving, depending on the setting. Programs in the NC memory are always automatically saved.
 - Exit the program correction mode using the "Close" softkey to return to the "Program manager" operating area.
-

See also

Editor settings (Page 182)

Correcting a program (Page 158)

Opening and closing the program (Page 772)

Generating a G code program (Page 264)

6.10.1 Searching in programs

You can use the search function to quickly arrive at points where you would like to make changes, e.g. in very large programs.

Various search options are available that enable selective searching.

Search options

- **Whole words**
Activate this option and enter a search term if you want to search for texts/terms that are present as words in precisely this form.
If, for example, you enter the search term "Finishing tool", only single "Finishing tool" terms are displayed. Word combinations such as "Finishing tool_10" are not found.
- **Exact expression**
Activate this option if you wish to search for terms with characters, which can also be used as place holders for other characters, e.g. "?" and "*".

Note

Search with place holders

When searching for specific program locations, you have the option of using place holders:

- "*": Replaces any character string
 - "?": Replaces any character
-

Precondition

The desired program is opened in the editor.

Procedure



1. Press the "Search" softkey.
A new vertical softkey bar appears.
The "Search" window opens at the same time.
2. Enter the desired search term in the "Text" field.
3. Select "Whole words" if you want to search for whole words only.
- OR -



4. Position the cursor in the "Direction" field and choose the search direction (forward, backward) with the <SELECT> key.



5. Press the "OK" softkey to start the search.

If the text you are searching for is found, the corresponding line is highlighted.





6. Press the "Continue search" softkey if the text located during the search does not correspond to the point you are looking for.

- OR -



Press the "Cancel" softkey when you want to cancel the search.

Further search options

Softkey	Function
	The cursor is set to the first character in the program.
	The cursor is set to the last character in the program.





6.10.2 Replacing program text

You can find and replace text in one step.

Precondition

The desired program is opened in the editor.

Procedure

1.  Press the "Search" softkey.
A new vertical softkey bar appears.
2.  Press the "Find and replace" softkey.
The "Find and Replace" window appears.
3. In the "Text" field, enter the term you are looking for and in the "Replace with" field, enter the text you would like to insert automatically during the search.
4.  Position the cursor in the "Direction" field and choose the search direction (forward, backward) with the <SELECT> key.
5.  Press the "OK" softkey to start the search.
If the text you are searching for is found, the corresponding line is highlighted.
6.  Press the "Replace" softkey to replace the text.

- OR -
Press the "Replace all" softkey to replace all text in the file that corresponds to the search term.

- OR -
Press the "Continue search" softkey if the text located during the search should not be replaced.

- OR -
Press the "Cancel" softkey when you want to cancel the search.

Note**Replacing texts**

- Read-only lines (;*RO*)
If hits are found, the texts are not replaced.
 - Contour lines (;*GP*)
If hits are found, the texts are replaced as long as the lines are not read-only.
 - Hidden lines (;*HD*)
If hidden lines are displayed in the editor and hits are found, the texts are replaced as long as the lines are not read-only. Hidden lines that are not displayed, are not replaced.
-

See also

Editor settings (Page 182)

6.10.3 Copying/pasting/deleting a program block

In the editor, you edit both basic G code as well as program steps such as cycles, blocks and subprogram calls.

Inserting program blocks

The editor responds depending on what type of program block you insert.

- If you insert a G code, then the program block is directly inserted where the write mark is located.
 - If you insert a program step, then the program block is always inserted at the next block, independent of the position of the write mark within the actual line. This is necessary as a cycle call always requires its own line.
This behavior is in all applications, irrespective of whether the program step is inserted with a screen form using "Accept" or "Insert" is used as editor function.
-

Note**Cutout program step and reinsert**

- If you cut out a program step at a specific location and you then directly reinsert it again, the sequence changes.
 - Press the shortcut (key combination) <CTRL> + <Z> to undo what you have cut out.
-

Precondition

The program is opened in the editor.

Procedure



1. Press the "Mark" softkey.

- OR -



Press the <SELECT> key.



2. Select the desired program blocks with the cursor or mouse.



3. Press the "Copy" softkey in order to copy the selection to the buffer memory.

4. Place the cursor on the desired insertion point in the program and press the "Paste" softkey.

The content of the buffer memory is pasted.

- OR -



Press the "Cut" softkey to delete the selected program blocks and to copy them into the buffer memory.

Note: When editing a program, you cannot copy or cut more than 1024 lines. While a program that is not on the NC is opened (progress display less than 100%), you cannot copy or cut more than 10 lines or insert more than 1024 characters.

Numbering the program blocks

If you have selected the "Automatic numbering" option for the editor, then the newly added program blocks are allocated a block number (N number).

The following rules apply:

- When creating a new program, the first line is allocated the "first block number".
- If, up until now, the program had no N number, then the program block inserted is allocated the starting block number defined in the "First block number" input field.
- If N numbers already exist before and after the insertion point of a new program block, then the N number before the insertion point is incremented by 1.
- If there are no N numbers before or after the insertion point, then the maximum N number in the program is increased by the "increment" defined in the settings.

Note:

After exiting the program, you have the option of renumbering the program blocks.

Note

The buffer memory contents are retained even after the editor is closed, enabling you to paste the contents in another program.

Note**Copy/cut current line**

To copy and cut the current line where the cursor is positioned, it is not necessary to mark or select it. You have the option of making the "Cut" softkey only operable for marked program sections via editor settings.

See also

Opening additional programs (Page 181)

Editor settings (Page 182)

Keys of the operator panel (Page 30)

6.10.4 Renumbering a program

You can modify the block numbering of programs opened in the editor at a later point in time.

Precondition

The program is opened in the editor.

Procedure

1. Press the ">>" softkey.
A new vertical softkey bar appears.



2. Press the "Renumber" softkey.
The "Renumbering" window appears.

3. Enter the values for the first block number and the increment to be used for numbering.



4. Press the "OK" softkey.
The program is renumbered.

Note

- If you only want to renumber a section, before the function call, select the program blocks whose block numbering you want to edit.
 - When you enter a value of "0" for the increment size, then all of the existing block numbers are deleted from the program and/or from the selected range.
-

6.10.5 Creating a program block

In order to structure programs to achieve a higher degree of transparency, you have the option of combining several blocks (G code and/or ShopTurn machining steps) to form program blocks.

Program blocks can be created in two stages. This means that you can form additional blocks within a block (nesting).

You then have the option of opening and closing these blocks depending on your requirement.

Display	Meaning
Text	Block designation
Spindle	<ul style="list-style-type: none"> Selecting the spindle Define at which spindle a program block is to be executed.
Addit. run-in code	<ul style="list-style-type: none"> Yes If the block is not to be executed, because the specified spindle is not to be used, it is possible to temporarily activate a so-called "Additional run-in code". No
Automat. retraction	<ul style="list-style-type: none"> Yes Block start and block end are moved to the tool change point, i.e. the tool is brought into a safe range. No

Structuring programs

- Before generating the actual program, generate a program frame using empty blocks.
- By forming blocks, structure existing G code or ShopTurn programs.

Procedure



1. Select the "Program manager" operating area.



2. Select the storage location and create a program or open a program. The program editor opens.



3. Select the required program blocks that you wish to combine to form a block.



4. Press the "Build group" softkey. The "Form New Block" window opens.



5. Enter a designation for the block, assign the spindle, if required, select the Additional run-in code and the automatic retraction and then press the "OK" softkey.

Opening and closing blocks

6. Press the ">>" and "View" softkeys.



7. Press the "Open all blocks" softkey if you wish to display the program with all the blocks.



8. Press the "Close all blocks" softkey, if you wish to display the program again in a structured form.

Removing a block

9. Open the block.
10. Position the cursor at the end of the block.
11. Press the "Remove block" softkey.

**Note**

You can also open and close blocks using the mouse or the cursor keys:

- <Cursor right> opens the block where the cursor is positioned
- <Cursor left> closes the block if the cursor is positioned at the beginning or end of the block
- <ALT> and <Cursor left> closes the block if the cursor is positioned within the block

Note

DEF statements in program blocks or block generation in the DEF part of a part program / cycle are not permitted.

6.10.6 Opening additional programs

You have the option of viewing and editing several programs simultaneously in the editor.

For instance, you can copy program blocks or machining steps of a program and paste them into another program.

Opening several programs

You have the option of opening up to ten program blocks.



1. In the program manager, select the programs that you wish to open and view in the multiple editor and then press on the "Open" softkey.

The editor is opened and the first two programs are displayed.



2. Press the <NEXT WINDOW> key to change to the next opened program.



3. Press the "Close" softkey to close the actual program.

Note

Pasting program blocks

JobShop machining steps cannot be copied into a G code program.

Precondition

You have opened a program in the editor.

Procedure



1. Press the ">>" and "Open additional program" softkeys.



The "Select Additional Program" window is opened.

2. Select the program or programs that you wish to display in addition to the already opened program.



3. Press the "OK" softkey.

The editor opens and displays both programs next to each another.

See also

Copying/pasting/deleting a program block (Page 177)

6.10.7 Editor settings

Enter the default settings in the "Settings" window that are to take effect automatically when the editor is opened.

Defaults

Setting	Meaning
Number automatically	<ul style="list-style-type: none"> • Yes: A new block number will automatically be assigned after every line change. In this case, the specifications provided under "First block number" and "Increment" are applicable. • No: No automatic numbering
First block number	Specifies the starting block number of a newly created program. The field is only visible when "Yes" is selected under "Number automatically".
Increment	Defines the increment used for the block numbers. The field is only visible when "Yes" is selected under "Number automatically".

Setting	Meaning
Display hidden lines	<ul style="list-style-type: none"> • Yes: Hidden lines marked with "*HD" (hidden) will be displayed. • No: Lines marked with ".*HD*" will not be displayed. <p>Note: Only visible program lines are taken into account with the "Search" and "Search and Replace" functions.</p>
Display block end as symbol	The "LF" (line feed) symbol ¶ is displayed at the block end.
Line break	<ul style="list-style-type: none"> • Yes: Long lines are broken and wrapped around. • No: If the program includes long lines, then a horizontal scrollbar is displayed. You can move the section of the screen horizontally to the end of the line.
Line break also in cycle calls	<ul style="list-style-type: none"> • Yes: If the line of a cycle call becomes too long, then it is displayed over several lines. • No: The cycle call is truncated. <p>The field is only visible if "Yes" is entered under "Line break".</p>
Visible programs	<ul style="list-style-type: none"> • 1 - 10 Select how many programs can be displayed next to one another in the editor. • Auto Specifies that the number of programs entered in a job list or up to ten selected programs will be displayed next to each other.
Width of the program with focus	Here, you enter the width of the program that has the input focus in the editor as a percentage of the window width.
Save automatically	<ul style="list-style-type: none"> • Yes: The changes are saved automatically when you change to another operating area. • No: You are prompted to save when changing to another operating area. Save or reject the changes with the "Yes" and "No" softkeys. <p>Note: Only for local and external drives.</p>
Cut only after selecting	<ul style="list-style-type: none"> • Yes: Parts of programs can only be cutout when program lines have been selected, i.e. the "Cutout" softkey only then is active. • No: The program line, in which the cursor is positioned, can be cut out without having to select it.
Determine machining times	<p>Defines which program runtimes are determined in the simulation or in automatic mode:</p> <ul style="list-style-type: none"> • Off Program runtimes are not determined. • Block-by-block: The runtimes are determined for each program block. • Non-modal: The runtimes are determined at the NC block level. <p>Note: You also have the option of displaying the cumulative times for blocks. Please observe the information provided by the machine manufacturer.</p> <p>After the simulation or after executing the program, the required machining times are displayed in the editor.</p>

Setting	Meaning
Saving machining times	<p>Specifies how the machining times determined are processed.</p> <ul style="list-style-type: none"> • Yes A subdirectory with the name "GEN_DATA.WPD" is created in the directory of the part program. There, the machining times determined are saved in an ini file together with the name of the program. The machining times are displayed again when the program or job list are reloaded. • No The machining times that have been determined are only displayed in the editor.
Display cycles as machining step	<ul style="list-style-type: none"> • Yes: The cycle calls in the G code programs are displayed as plain text. • No: The cycle calls in the G code programs are displayed in the NC syntax.
Highlight selected G code commands	<p>Defines the display of G code commands.</p> <ul style="list-style-type: none"> • No All G code commands are displayed in the standard color. • Yes Selected G code commands or keywords are highlighted in color. Define the rules for the color assignment in the sleditorwidget.ini configuration file. <p>Note: Please observe the information provided by the machine manufacturer.</p> <p>Note This setting also has an effect on the current block display.</p>
Font size	<p>Defines the font size for the editor and the display of the program sequence.</p> <ul style="list-style-type: none"> • auto If you open a second program, then the smaller font size is automatically used. • normal (16) - character height in pixels Standard font size that is displayed with the appropriate screen resolution. • small (14) - character height in pixels More content is displayed in the editor. <p>Note This setting also has an effect on the current block display.</p>

Note

All entries that you make here are effective immediately.

Requirement

You have opened a program in the editor.

Procedure



1. Select the "Program" operating area.



2. Press the "Edit" softkey.



3. Press the ">>" and "Settings" softkeys.
The "Settings" window opens.



4. Make the required changes.



5. Press the "Delete mach. times" softkey if you wish to delete the machining times.

The machining times that have been determined are deleted from the editor as well as from the actual block display. If the machining times are saved to an ini file, then this file is also deleted.



6. Press the "OK" softkey to confirm the settings.

See also

Replacing program text (Page 176)

6.11 Working with DXF files

6.11.1 Overview

The "DXF-Reader" function can be used to open files created in the SINUMERIK Operate editor directly in a CAD system as well as contours and drilling positions to be transferred and stored directly in G code and ShopTurn programs.

The DXF file can be displayed in the Program Manager.



Software option

You require the "DXF-Reader" software option in order to use this function.



Machine manufacturer

Please observe the information provided by the machine manufacturer.

6.11.2 Displaying CAD drawings

6.11.2.1 Open a DXF file

Procedure



1. Select the "Program Manager" operating area.



2. Choose the desired storage location and position the cursor on the DXF file that you want to display.

3. Press the "Open" softkey.

The selected CAD drawing will be displayed with all its layers, i.e. with all graphic levels.



4. Press the "Close" softkey to close the CAD drawing and to return to the Program Manager.

6.11.2.2 Cleaning a DXF file

All contained layers are shown when a DXF file is opened.

Layers that do not contain any contour- or position-relevant data can be shown or hidden.

Requirement

The DXF file is open in the Program Manager or in the editor.

Procedure



1. Press the "Clean" and "Layer selection" softkeys if you want to hide specific layers.
The "Layer Selection" window opens.

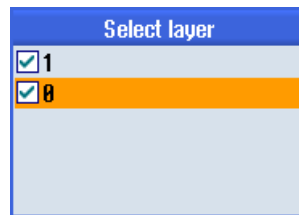

2. Deactivate the required layers and press the "OK" softkey.

- OR -



Press the "Clean automat." softkey to hide all non-relevant layers.



3. Press the "Clean automat." softkey to redisplay the layers.

6.11.2.3 Enlarging or reducing the CAD drawing

Requirement

The DXF file is opened in the Program Manager.

Procedure



1. Press the "Details" and "Zoom +" softkeys if you wish to enlarge the size of the segment.

- OR -



2. Press the "Details" and "Zoom -" softkeys if you wish to reduce the size of the segment.

- OR -



3. Press the "Details" and "Auto zoom" softkeys if you wish to automatically adapt the segment to the size of the window.



- OR -



4. Press the "Details" and "Zoom elem. selection" softkeys if you want to automatically zoom elements that are in a selection set.

6.11.2.4 Changing the section

If you want to move or change the size of a section of the drawing, for example, to view details or redisplay the complete drawing later, use the magnifying glass. You can use the magnifying glass to determine the section and then change its size.

Requirement

The DXF file is opened in the Program Manager or in the editor.

Procedure



1. Press the "Details" and "Magnifying glass" softkeys. A magnifying glass in the shape of a rectangular frame appears.



2. Press the <+> key to enlarge the frame.

- OR -



Press the <-> key to reduce the frame.

- OR -



Press a cursor key to move the frame up, down, left or right.



3. Press the "OK" softkey to accept the section.

6.11.2.5 Rotating the view

You can change the orientation of the drawing.

Requirement

The DXF file is open in the Program Manager or in the editor.

Procedure



1. Press the "Details" and "Rotate figure" softkeys.



2. Press the "Arrow right", "Arrow left", "Arrow up", "Arrow down", "Arrow clockwise" or "Arrow counter-clockwise" softkey to change the position of the drawing.

...



6.11.2.6 Displaying/editing information for the geometric data

Precondition

The DXF file is opened in the Program Manager or in the editor.

Procedure



1. Press the "Details" and "Geometry info" softkeys.
The cursor takes the form of a question mark.



2. Position the cursor on the element for which you want to display its geometric data and press the "Element Info" softkey.

If, for example, you have selected a straight line, the following window opens "Straight line on layer: ...". You are shown the coordinates corresponding to the actual zero point in the selected layer: Start point for X and Y, end point for X and Y as well as the length.



4. If you are currently in the editor, press the "Element edit" softkey.
The coordinate values can be edited.



3. Press the "Back" softkey to close the display window.

Note

Editing a geometric element

You can use this function to make smaller changes to the geometry, e.g. for missing intersections.

You should make larger changes in the input screen of the editor.

You cannot undo any changes that you make with "Element Edit".

6.11.3 Importing and editing a DXF file in the editor





6.11.3.1 General procedure

- Create/open a G code or ShopTurn program
- Call the "Turn contour" cycles and create a "New contour"
- OR -
- Call from "Drill" cycle "Position / position pattern"
- Import the DXF file
- Select the contour or drilling positions in the DXF file or CAD drawing and click "OK" to accept the cycle
- Add the program block with "Accept" to the G code or ShopTurn program

6.11.3.2 Specifying a reference point

Because the zero point of the DXF file normally differs from the zero point of the CAD drawing, specify a reference point.

Procedure

1. The DXF file is opened in the editor.
2. Press the ">>" and "Specify reference point" softkeys.

3. Press the "Element start" softkey to place the zero point at the start of the selected element.
- OR -
Press the "Element center" softkey to place the zero point at the center of the selected element.
- OR -





Press the "Element end" softkey to place the zero point at the end of the selected element.

- OR -



Press the "Arc center" softkey to place the zero point at the center of an arc.

- OR -



Press the "Cursor" softkey to define the zero point at any cursor position.

- OR -



Press the "Free input" softkey to open the "Reference Point Input" window and enter the values for the positions (X, Y) there.

6.11.3.3 Assigning the machining plane

You can select the machining plane in which the contour created with the DXF reader should be located.

Procedure



1. The DXF file is opened in the editor.

2. Press the "Select plane" softkey.
The "Select Plane" window opens.



3. Select the desired plane and press the "OK" softkey.

6.11.3.4 Setting the tolerance

To allow even inaccurately created drawings to be used, i.e. to compensate for gaps in the geometry, you can enter a snap radius in millimeters. This relates elements.

Note

Large snap radius

The larger that the snap radius is set, the larger the number of available following elements.

Procedure



1. The DXF file is opened in the editor.

2. Press the "Details" and "Snap radius" softkeys.
The "Input" window appears.

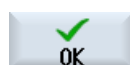

3. Enter the desired value and press the "OK" softkey.

6.11.3.5 Selecting the machining range / deleting the range and element









You can select ranges in the DXF file and therefore reduce the elements. After accepting the 2nd position, only the contents of the selected rectangle are displayed. Contours are cut to the rectangle.

Requirement

The DXF file is open in the editor.

Procedure



Select the machining range from the DXF file

- | | |
|---|---|
|  | 1. Press the "Reduce" and "Select range" softkeys if you want to select specific ranges of the DXF file.
An orange rectangle is displayed. |
|  | |
|  | 2. Press the "Range +" softkey to enlarge the section or press the "Range -" softkey to reduce the section. |
|  | |
|  | 3. Press the "Arrow right", "Arrow left", "Arrow up" or "Arrow down" softkey to move the selection tool. |
|  | |
|  | 4. Press the "OK" softkey.
The machining section is displayed. |
|  | Use the "Cancel" softkey to return to the previous window. |
|  | 5. Press the "Deselect range" softkey to undo the selection of the machining range.
The DXF file is reset to the original display. |

Delete selected ranges and elements of the DXF file

- | | |
|---|--------------------------------|
|  | 6. Press the "Reduce" softkey. |
|---|--------------------------------|

Delete range

- | | |
|---|---|
|  | 7. Press the "Range delete" softkey.
A blue rectangle is displayed. |
|  | 8. Press the "Range +" softkey to enlarge the section or press the "Range -" softkey to reduce the section. |
|  | |



9. Press the "Arrow right", "Arrow left", "Arrow up" or "Arrow down" softkey to move the selection tool.



- OR -

Delete element



10. Press the "Element delete" softkey, and using the selection tool, select the element that you wish to delete.

11. Press "OK".

6.11.3.6 Saving the DXF file

You can save DXF files that you have reduced and edited.

Requirement

The DXF file is open in the editor.

Procedure



1. Reduce file according to your requirements and/or select the working areas.



- OR -



2. Press the "Back" and ">>" softkeys.



3. Press the "Save DXF" softkey.



4. Enter the required name in the "Save DXF Data" window and press "OK". The "Save As" window opens.

5. Select the required storage location.









6. If required, press the "New directory" softkey, enter the required name in the "New Directory" window and press the "OK" softkey to create a directory.



7. Press the "OK" softkey.

6.11.3.7 Transferring the drilling positions

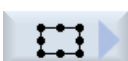
Calling the cycles

- | | |
|---|---|
|  | 1. The part program or ShopTurn program to be edited has been created and you are in the editor. |
|  | 2. Press the "Drilling" softkey. |
|  | 3. Press the "Positions" softkey. |
|  | 4. Press the "Arbitrary positions" softkey.
The "Positions" input window opens.
- OR -
Press the "Line" softkey.
The "Position Row" input window opens.
- OR - |
|  | Press the "Grid" softkey.
The "Position Grid" input window opens.
- OR |
|  | Press the "Frame" softkey.
The "Position Frame" input window opens.
- OR - |
|  | Press the "Circle" softkey.
The "Position Circle" input window opens.
- OR - |
|  | Press the "Partial circle" softkey.
The "Position Partial Circle" input window opens. |



Selecting the drilling positions

Requirement

You have selected a position pattern.

Procedure

Opening a DXF file

- | | |
|---|---|
|  | 1. Press the "Import from DXF" softkey. |
|  | 2. Position the cursor on the desired DXF file in the storage directory.
You can use the search function to search directly for a DXF file in comprehensive folders and directories. |

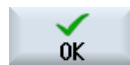

3. Press the "OK" softkey.
The CAD drawing opens and the cursor takes the form of a cross.

Cleaning a file

4. Prior to selecting the drilling positions, you can select a layer and clean the file.

Specifying a reference point

5. If required, specify a zero point.

Specify clearance(s) (position pattern "Row"/"Arbitrary positions" and "Circle"/"Pitch circle")



6. Press the "Select element" softkey repeatedly to navigate through the orange selection symbol to the desired drilling position.

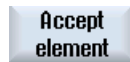

7. Press the "Accept element" softkey to transfer the position.
Repeat steps 6 and 7 to specify other drilling positions for "Arbitrary positions".

Specify clearance with second clearance (for position pattern "Frame", "Grid")



8. Once the reference point has been specified, press the "Select element" softkey repeatedly to navigate to the desired drilling position in order to specify the clearance.

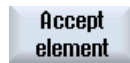

9. Press the "Accept element" softkey.
A rectangular cross-hair appears.



10. Press the "Select element" repeatedly to navigate to the desired drilling position on the displayed line.
To determine the second clearance, drilling positions must be located on the line.



11. Press the "Accept element" softkey.
A frame or grid is displayed.

Size (position pattern "Row", "Frame", "Grid")



12. Once the reference point and clearances have been specified, press the "Select element" softkey repeatedly.
All expansions of the frame or the grid are displayed.



13. Press the "Accept element" softkey to confirm the selected frame or grid.
If all elements for the position row or position frame and position grid are valid, the drilling positions are displayed with blue points.

Circle direction (circle and pitch circle)



Once the reference point and clearance have been specified, press the "Select element" softkey repeatedly.
The circle is shown in the possible orientations.



Press the "Select element" softkey to confirm the selected circle or pitch circle.
If all elements of the circle or pitch circle are valid, the drilling positions are displayed with blue points.

Resetting actions



Undo can be used to reset the last actions.

Transfer drilling positions to the cycle and the program



4. Press the "OK" softkey in order to accept the position values. You return to the associated parameter screen form. Press the "Accept" softkey to transfer the drilling positions to the program.



Operation with mouse and keyboard

In addition to operation using softkeys, you can also operate the functions with the keyboard and with the mouse.

6.11.3.8 Accepting contours

Calling the cycles



1. The part program or ShopTurn program to be processed has been created and you are in the editor.
2. Press the "Contour turning" softkey.
3. Press the "New contour" softkey.

Selecting contours

The start and end point are specified for the contour line.

The start point and the direction are selected on a selected element. Beginning at the start point, the automatic contour line takes all subsequent elements of a contour. The contour line ends as soon as there are no subsequent elements – or intersections with other elements of the contour occur.

Note

If a contour includes more elements than can be processed, you will be offered the option of transferring the contour to the program as pure G code.

This contour then can no longer be edited in the editor.







With the "Undo" softkey, you can undo your contour selection back to a specific point.

Procedure

Opening a DXF file



1. Enter the desired name in the "New Contour" window.

- 
2. Press the "From DXF file" and "Accept" softkeys.
The "Open DXF File" window opens.
- 
3. Select a storage location and place the cursor on the relevant DXF file.
You can, for example, use the search function to search directly for a DXF file in comprehensive folders and directories.
- 
4. Press the "OK" softkey.
The CAD drawing opens and can be edited for contour selection.
The cursor takes the form of a cross.
- 









Specifying a reference point

5. If required, specify a zero point.

Contour line

- 
6. Press the ">>" and "Automatic" softkeys if you want to accept the largest possible number of contour elements.
This makes it fast to accept contours that consist of many individual elements.
- 
- OR -
- 
- Press "Only to 1st cut" if you do not want to accept the complete contour elements at once.
The contour will be followed to the first cut of the contour element.

Defining the start point

- 
7. Press the "Select element" softkey to select the desired element.
- 
8. Press the "Accept element" softkey.
- 
9. Press the "Element start point" softkey to place the contour start at the start point of the element.
- OR -
- 
- Press the "Element end point" softkey to place the contour start at the end point of the element.
- OR -
- 
- Press the "Element center" softkey to place the contour start at the center of the element.
- OR -
- 
- Press the "Cursor" softkey to define the start of the element with the cursor at any position.
- 
9. Press the "OK" softkey to confirm your selection.
- 
10. Press the "Accept element" softkey to accept the offered elements.
The softkey can be operated while elements are still available to be accepted.

Specifying the end point



11. Press the ">>" and "Specify end point" softkeys if you do not want to accept the end point of the selected element.



12. Press the "Current position" softkey if you want to set the currently selected position as end point.

- OR -



Press the "Element center" softkey to place the contour end at the center of the element.

- OR -



Press the "Element end" softkey to place the contour end at the end of the element.

- OR -



Press the "Cursor" softkey to define the start of the element with the cursor at any position.

Transferring the contour to the cycle and to the program



Press the "OK" softkey.

The selected contour is transferred to the contour input screen of the editor.



Press the "Accept contour" softkey.

The program block is transferred to the program.

Operation with mouse and keyboard

In addition to operation using softkeys, you can also operate the functions with the keyboard and with the mouse.

6.12 Display and edit user variables

6.12.1 Overview

The defined user data may be displayed in lists.

User variables

The following variables can be defined:

- Global arithmetic parameters (RG)
- Arithmetic parameters (R parameters)
- Global user data (GUD) is valid in all programs
- Local user variables (LUD) are valid in the program where they have been defined.
- Program-global user variables (PUD) are valid in the program in which they have been defined, as well as in all of the subprograms called by this program

Channel-specific user data can be defined with a different value for each channel.

Entering and displaying parameter values

Up to 15 positions (including decimal places) are evaluated. If you enter a number with more than 15 places, it will be written in exponential notation (15 places + EXXX).

LUD or PUD

Only local or program-global user data can be displayed at one time.

Whether the user data are available as LUD or PUD depends on the current control configuration.



Machine manufacturer

Please observe the information provided by the machine manufacturer.

Note

Reading and writing variables protected

Reading and writing of user data are protected via a keyswitch and protection levels.

Comments

For R arithmetic parameters and global R parameters you have the option of saving associated comments.

Searching for user data

You may search for user data within the lists using any character string.

References

You will find additional information in the following references:

Programming Manual Job Planning / SINUMERIK 840D sl / 828D

6.12.2 Global R parameters

Global R parameters are arithmetic parameters, which exist in the control itself, and can be read or written to by all channels.

You use global R parameters to exchange information between channels, or if global settings are to be evaluated for all channels.

These values are retained after the controller is switched off.

Comments

You can save comments in the "Global R parameters with comments" window.

These comments can be edited. You have the option of either individually deleting these comments, or using the delete function.

These comments are retained after the control is switched off.

Number of global R parameters

The number of global R parameters is defined in a machine data element.

Range: RG[0]– RG[999] (dependent on the machine data).

There are no gaps in the numbering within the range.



Machine manufacturer

Please observe the information provided by the machine manufacturer.

Procedure

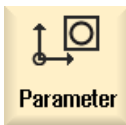

1. Select the "Parameter" operating area.
2. Press the "User variable" softkey.
3. Press the "Global R parameters" softkey.
The "Global R parameters" window opens.

Display comments

1. Press the ">>" and "Display comments" softkeys.
The "Global R parameters with comments " window opens.



2. Press the "Display comments" softkey once again to return to the "Global R parameters" window.

Deleting R parameters and comments

1. Press the ">>" and "Delete" softkeys.
The "Delete global R parameters" window opens.



2. In fields "from global R parameters" and "to global R parameters", select the global R parameters whose values you wish to delete.
- OR -



Press the "Delete all" softkey.

3. Activate the checkbox "also delete comments" if the associated comments should also be automatically deleted.

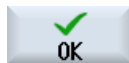

4. Press the "OK" softkey.

- A value of 0 is assigned to the selected global R parameters – or to all global R parameters.
- The selected comments are also deleted.

6.12.3 R parameters

R parameters (arithmetic parameters) are channel-specific variables that you can use within a G code program. G code programs can read and write R parameters.

These values are retained after the controller is switched off.

Comments

You can save comments in the "R parameters with comments" window.

These comments can be edited. You have the option of either individually deleting these comments, or using the delete function.

These comments are retained after the control is switched off.

Number of channel-specific R parameters

The number of channel-specific R parameters is defined in a machine data element.

Range: R0-R999 (dependent on machine data).

There are no gaps in the numbering within the range.



Machine manufacturer

Please observe the information provided by the machine manufacturer.

Procedure



1. Select the "Parameter" operating area.



2. Press the "User variable" softkey.



3. Press the "R variables" softkey.
The "R parameters" window appears.

Display comments



1. Press the ">>" and "Display comments" softkeys.
The "R parameters with comments" window opens.



2. Press the "Display comments" softkey once again to return to the "R parameters" window.



Delete R variables



1. Press the ">>" and "Delete" softkeys.
The "Delete R parameters" window appears.



2. In fields "from R parameters" and "to R parameters", select the R parameters whose values you wish to delete.
- OR -



Press the "Delete all" softkey.

3. Activate the checkbox "also delete comments" if the associated comments should also be automatically deleted.



4. Press the "OK" softkey.

- A value of 0 is assigned to the selected R parameters or to all R parameters.
- The selected comments are also deleted.

6.12.4 Displaying global user data (GUD)

Global user variables

Global GUDs are NC global user data (**Global User Data**) that remains available after switching the machine off.

GUDs apply in all programs.

Definition

A GUD variable is defined with the following:

- Keyword DEF
- Range of validity NCK
- Data type (INT, REAL,)
- Variable names
- Value assignment (optional)

Example

```
DEF NCK INT ZAEHLER1 = 10
```

GUDs are defined in files with the ending DEF. The following file names are reserved for this purpose:

File name	Meaning
MGUD.DEF	Definitions for global machine manufacturer data
UGUD.DEF	Definitions for global user data
GUD4.DEF	User-definable data
GUD8.DEF, GUD9.DEF	User-definable data

Procedure

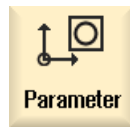

1. Select the "Parameter" operating area.



2. Press the "User variable" softkey.



3. Press the "Global GUD" softkeys.

The "Global User Variables" window is displayed. A list of the defined UGUD variables will be displayed.

- OR -



Press the "GUD selection" softkey and the "SGUD" to "GUD6" softkeys if you wish to display SGUD, MGUD, UGUD as well as GUD4 to GUD 6 of the global user variables.

- OR -

Press the "GUD selection" and ">>" softkeys as well as the "GUD7" to "GUD9" softkeys if you want to display GUD 7 to GUD 9 of the global user variables.

Note

After each start-up, a list with the defined UGUD variables is displayed in the "Global User Variables" window.

6.12.5 Displaying channel GUDs

Channel-specific user variables

Like the GUDs, channel-specific user variables are applicable in all programs for each channel. However, unlike GUDs, they have specific values.

Definition

A channel-specific GUD variable is defined with the following:

- Keyword DEF
- Range of validity CHAN
- Data type
- Variable names
- Value assignment (optional)

Example

```
DEF CHAN REAL X_POS = 100.5
```

Procedure

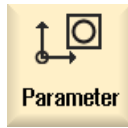

1. Select the "Parameter" operating area.



2. Press the "User variable" softkey.



3. Press the "Channel GUD" and "GUD selection" softkeys.



A new vertical softkey bar appears.



4. Press the "SGUD" ... "GUD6" softkeys if you want to display the SGUD, MGUD, UGUD as well as GUD4 to GUD 6 of the channel-specific user variables.



- OR -



Press the "Continue" softkey and the "GUD7" ... "GUD9" softkeys if you want to display GUD 7 and GUD 9 of the channel-specific user variables.



6.12.6 Displaying local user data (LUD)

Local user variables

LUDs are only valid in the program or subprogram in which they were defined.

The controller displays the LUDs after the start of program processing. The display is available until the end of program processing.

Definition

A local user variable is defined with the following:

- Keyword DEF
- Data type
- Variable names
- Value assignment (optional)

Procedure

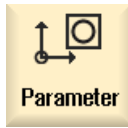

1. Select the "Parameter" operating area.



2. Press the "User variable" softkey.



3. Press the "Local LUD" softkey.

6.12.7 Displaying program user data (PUD)

Program-global user variables

PUDs are global part program variables (**P**rogram **U**ser **D**ata). PUDs are valid in all main programs and subprograms, where they can also be written and read.



Machine manufacturer

Please refer to the machine manufacturer's specifications.

Procedure



1. Select the "Parameter" operating area.



2. Press the "User variable" softkey.



3. Press the "Program PUD" softkey.

6.12.8 Searching for user variables

You can search for R parameters and user variables.

Procedure

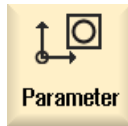

1. Select the "Parameter" operating area.



2. Press the "User variable" softkey.



3. Press the "R parameters", "Global GUD", "Channel GUD", "Local GUD" or "Program PUD" softkeys to select the list in which you would like to search for user variables.



4. Press the "Search" softkey.
The "Search for R Parameters" or "Search for User Variables" window opens.



5. Enter the desired search term and press "OK".

The cursor is automatically positioned on the R parameters or user variables you are searching for, if they exist.

By editing a DEF/MAC file, you can alter or delete existing definition/macro files or add new ones.

Procedure

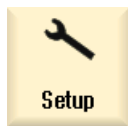

1. Select the "Start-up" operating area.



2. Press the "System data" softkey.

3. In the data tree, select the "NC data" folder and then open the "Definitions" folder.

4. Select the file you want to edit.

5. Double-click the file.

- OR -

Press the "Open" softkey.



- OR -

Press the <INPUT> key.



- OR -

Press the <Cursor right> key.



The selected file is opened in the editor and can be edited there.



6. Define the desired user variable.
7. Press the "Exit" softkey to close the editor.

Activating user variables



1. Press the "Activate" softkey.

A prompt is displayed.
2. Select whether the current values in the definition files should be retained
- OR -
Select whether the current values in the definition files should be deleted.
This will overwrite the definition files with the initial values.
3. Press the "OK" softkey to continue the process.

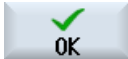

6.13 Displaying G functions and auxiliary functions

6.13.1 Selected G functions

16 selected G groups are displayed in the "G Function" window.

Within a G group, the G function currently active in the controller is displayed.

Some G codes (e.g. G17, G18, G19) are immediately active after switching the machine control on.

Which G codes are always active depends on the settings.



Machine manufacturer

Please refer to the machine manufacturer's specifications.

G groups displayed by default

Group	Meaning
G group 1	Modally active motion commands (e.g. G0, G1, G2, G3)
G group 2	Non-modally active motion commands, dwell time (e.g. G4, G74, G75)
G group 3	Programmable offsets, working area limitations and pole programming (e.g. TRANS, ROT, G25, G110)
G group 6	Plane selection (e.g. G17, G18)
G group 7	Tool radius compensation (e.g. G40, G42)
G group 8	Settable work offset (e.g. G54, G57, G500)
G group 9	Offset suppression (e.g. SUPA, G53)
G group 10	Exact stop - continuous-path mode (e.g. G60, G641)
G group 13	Workpiece dimensioning inches/metric (e.g. G70, G700)
G group 14	Workpiece dimensioning absolute/incremental (G90)
G group 15	Feedrate type (e.g. G93, G961, G972)
G group 16	Feedrate override on inside and outside curvature (e.g. CFC)
G group 21	Acceleration profile (e.g. SOFT, DRIVE)
G group 22	Tool offset types (e.g. CUT2D, CUT2DF)
G group 29	Radius/diameter programming (e.g. DIAMOF, DIAMCYCOF)
G group 30	Compressor ON/OFF (e.g. COMPOF)

G groups displayed by default (ISO code)

Group	Meaning
G group 1	Modally active motion commands (e.g. G0, G1, G2, G3)
G group 2	Non-modally active motion commands, dwell time (e.g. G4, G74, G75)
G group 3	Programmable offsets, working area limitations and pole programming (e.g. TRANS, ROT, G25, G110)
G group 6	Plane selection (e.g. G17, G18)

6.13 Displaying G functions and auxiliary functions

Group	Meaning
G group 7	Tool radius compensation (e.g. G40, G42)
G group 8	Settable work offset (e.g. G54, G57, G500)
G group 9	Offset suppression (e.g. SUPA, G53)
G group 10	Exact stop - continuous-path mode (e.g. G60, G641)
G group 13	Workpiece dimensioning inches/metric (e.g. G70, G700)
G group 14	Workpiece dimensioning absolute/incremental (G90)
G group 15	Feedrate type (e.g. G93, G961, G972)
G group 16	Feedrate override on inside and outside curvature (e.g. CFC)
G group 21	Acceleration profile (e.g. SOFT, DRIVE)
G group 22	Tool offset types (e.g. CUT2D, CUT2DF)
G group 29	Radius/diameter programming (e.g. DIAMOF, DIAMCYCOF)
G group 30	Compressor ON/OFF (e.g. COMPOF)

Procedure



1. Select the "Machine" operating area.



2. Press the <JOG>, <MDA> or <AUTO> key.

...



3. Press the "G functions" softkey.
The "G Functions" window is opened.



4. Press the "G functions" softkey again to hide the window.

The G groups selection displayed in the "G Functions" window may differ.



Machine manufacturer

Please refer to the machine manufacturer's specifications.

References

For more information about configuring the displayed G groups, refer to the following document:
SINUMERIK Operate Commissioning Manual

6.13.2 All G functions

All G groups and their group numbers are listed in the "G Functions" window.

Within a G group, only the G function currently active in the controller is displayed.

Additional information in the footer

The following additional information is displayed in the footer:

- Actual transformations

Display	Meaning
TRANSMIT	Polar transformation active
TRACYL	Cylinder surface transformation active
TRAORI	Orientation transformation active
TRAANG	Inclined axis transformation active
TRACON	Cascaded transformation active For TRACON, two transformations (TRAANG and TRACYL or TRAANG and TRANSMIT) are activated in succession.

- Current work offsets
- Spindle speed
- Path feedrate
- Active tool

6.13.3 G functions for mold making

In the window "G functions", important information for machining free-form surfaces can be displayed using the "High Speed Settings" function (CYCLE832).



Software option

You require the "Advanced Surface" software option in order to use this function.

High-speed cutting information

In addition to the information that is provided in the "All G functions" window, the following programmed values of the following specific information is also displayed:

- CTOL
- OTOL
- STOLF

The tolerances for G0 are only displayed if they are active.

Particularly important G groups are highlighted.

You have the option to configure which G functions are highlighted.

References

- Additional information is available in the following references:
Function Manual, Basic Functions; Chapter, "Contour/orientation tolerance"
- For information about configuring the displayed G groups, refer to the following document:
SINUMERIK Operate Commissioning Manual

Procedure

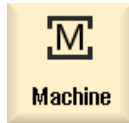

1. Select the "Machine" operating area



2. Press the <JOG>, <MDI> or <AUTO> key.



3. Press the ">>" and "All G functions" softkeys.
The "G Functions" window is opened.



See also

High-speed settings (CYCLE832) (Page 609)

6.13.4 Auxiliary functions

Auxiliary functions include M and H functions preprogrammed by the machine manufacturer, which transfer parameters to the PLC to trigger reactions defined by the manufacturer.

Displayed auxiliary functions

Up to five current M functions and three H functions are displayed in the "Auxiliary Functions" window.

Procedure

1. Select the "Machine" operating area.



2. Press the <JOG>, <MDA> or <AUTO> key.

...



3. Press the "H functions" softkey.
The "Auxiliary Functions" window opens.



4. Press the "H functions" softkey again to hide the window again.

6.14 Displaying superimpositions

You can display handwheel axis offsets or programmed superimposed movements in the "Superimpositions" window.

Input field	Meaning
Tool	Current superimposition in the tool direction
Min	Minimum value for superimposition in the tool direction
Max	Maximum value for superimposition in the tool direction
DRF	Displays the handwheel axis offset

The selection of values displayed in the "Superimposition" window may differ.



Machine manufacturer

Please observe the information provided by the machine manufacturer.

Procedure



1. Select the "Machine" operating area.



2. Press the <AUTO>, <MDI> or <JOG> key.

...



3. Press the ">>" and "Superimposition" softkeys.
The "Superimposition" window opens.



4. Enter the required new minimum and maximum values for superimposition and press the <INPUT> key to confirm your entries.

Note:

You can only change the superimposition values in "JOG" mode.



5. Press the "Superimposition" softkey again to hide the window.

You can display status information for diagnosing synchronized actions in the "Synchronized Actions" window.

You get a list with all currently active synchronized actions.

In this list, the synchronized action programming is displayed in the same form as in the part program.

References

Programming Guide Job Planning (PGA) Chapter: Motion-synchronous actions

Status of synchronized actions

You can see the status of the synchronized actions in the "Status" column.

- Waiting
- Active
- Blocked

Non-modal synchronized actions can only be identified by their status display. They are only displayed during execution.

Synchronization types

Synchronization types	Meaning
ID=n	Modal synchronized actions in the automatic mode up to the end of program, local to program; n = 1... 254
IDS=n	Static synchronized actions, modally effective in every operating type, also beyond the end of program; n = 1... 254
Without ID/IDS	Non-modal synchronized actions in the automatic mode

Note

Numbers from the number range 1 to 254 can only be assigned once, irrespective of the identification number.

Display of synchronized actions

Using softkeys, you have the option of restricting the display to activated synchronized actions.

Procedure



Machine

1. Select the "Machine" operating area.



2. Press the <AUTO>, <MDA> or <JOG> key.



3. Press the menu forward key and the "Synchron." softkey.
The "Synchronized Actions" window appears.
You obtain a display of all activated synchronized actions.



6.14 Displaying superimpositions



- 4. Press the "ID" softkey if you wish to hide the modal synchronized actions in the automatic mode.



- AND / OR -

Press the "IDS" softkey if you wish to hide static synchronized actions.



- AND / OR -

Press the "Blockwise" softkey if you wish to hide the non-modal synchronized actions in the automatic mode.



- 5. Press the "ID", "IDS" or "Blockwise" softkeys to re-display the corresponding synchronized actions.

...



6.15 Mold making view

For large mold making programs such as those provided by CAD/CAM systems, you have the option to display the machining paths by using a fast view. This provides you with a fast overview of the program, and you have the possibility of correcting it.



Machine manufacturer

The mold making view has possibly been hidden.

Please refer to the machine manufacturer's instructions.

Checking the program

You can check the following:

- Does the programmed workpiece have the correct shape?
- Are there large traversing errors?
- Which program block hasn't been correctly programmed?
- How is the approach and retraction realized?

NC blocks that can be interpreted

The following NC blocks are supported for the mold making view:

- Types
 - Lines
G0, G1 with X Y Z
 - Circles
G2, G3 with center point I, J, K or radius CR, depending on the working plane G17, G18, G19, CIP with circular point I1, J1, K1 or radius CR
 - Absolute data AC and incremental data IC are possible
 - For G2, G3 and different radii at the start and end, an Archimedes spiral is used
- Orientation
 - Rotary axis programming with ORIAXES or ORIVECT using ABC for G0, G1, G2, G3, CIP, POLY
 - Orientation vector programming with ORIVECT using A3, B3, C3 for G0, G1, G2, G3, CIP
 - Rotary axes can be specified using DC
- G codes
 - Working planes (for circle definition G2, G3): G17 G18 G19
 - Incremental or absolute data: G90 G91

The following NC blocks are **not** supported for the mold making view:

- Helix programming
- Rational polynomials
- Other G codes or language commands

All NC blocks that cannot be interpreted are simply overread.

Simultaneous view of the program and mold making view

You have the option of displaying the mold making view next to the program blocks in the editor.

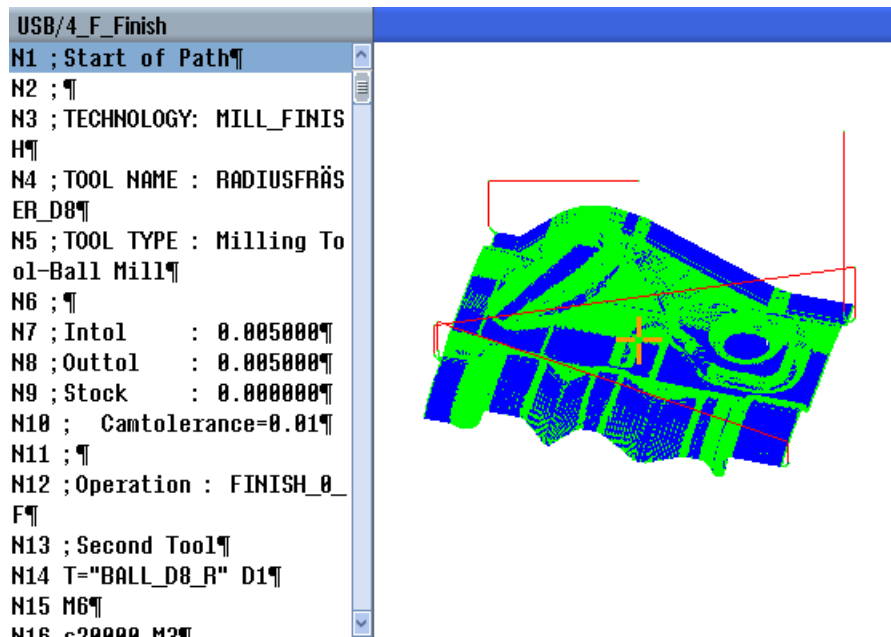

You can navigate back and forth between the NC blocks listed on the left and the associated points in the mold making view.

- On the left in the editor, if you place the cursor on an NC block with position data, then this NC block is marked in the graphic view.
- If you select a point on the right in the mold making view using the mouse, then conversely you mark the corresponding NC block on the left-hand side of the editor. This is how you jump directly to a position in the program in order to edit a program block for example.

Switch between the program window and the mold making view



Press the <NEXT WINDOW> key if you wish to toggle between the program window and the mold making view.

Changing and adapting the mold making view

Like simulation and simultaneous recording, you have the option of changing and adapting the mold making view in order to achieve the optimum view.

- Increasing or reducing the size of the graphic
- Moving the graphic
- Rotating the graphic
- Changing the section

6.15.1 Starting the mold making view

Procedure



1. Select the "Program manager" operating area.



2. Select the program that you would like to display in the mold making view.

3. Press the "Open" softkey.

The program is opened in the editor.



4. Press the ">>" and "Mold making view" softkeys.

The editor splits up into two areas.



The G code blocks are displayed in the left half of the editor.



The workpiece is displayed in the mold making view on the right-hand side of the editor. All of the points and paths programmed in the part program are represented.

6.15.2 Adapting the mold making view

You can adapt the graphic in various ways to better assess the workpiece in the mold making view.

Preconditions

- The required program is opened in the mold making view.
- The "Graphic" softkey is active.

Procedure



1. Press the softkey "Hide G1/G2/G3" if you want to conceal the machining paths.
- OR -



2. Press the softkey "Hide G0" if you want to deactivate the approach and retraction paths.
- OR -



Press softkey "Hide points" to conceal all the points in the graphic.

Note:

You have the option of simultaneously hiding G1/G2/G3 and G0 lines. In this case softkey "Hide points" is deactivated.

- OR -



Press the softkeys ">>" and "Vectors" to display all orientation vectors.



Note:

This softkey can only be operated if vectors are programmed.

- OR -



Press the softkeys ">>" and "Surface" to calculate the surface area of the workpiece.



- OR -



Press the softkeys ">>" and "Curvature".



The "Curvature" input window opens.



Enter the desired minimum and maximum value and press "OK" to confirm the entry and to highlight the curvature changes in color.

6.15.3 Specifically jump to the program block

If you notice anything peculiar in the graphic or identify an error, then from this location, you can directly jump to the program block involved where you can edit the program.

Requirements

- The required program is opened in the mold making view.
- The "Graphic" softkey is active.

Procedure

1. Press the ">>" and "Select point" softkeys.
Cross-hairs for selecting a point are shown in the diagram.

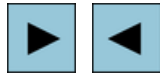

2. Using the cursor keys, move the cross-hairs to the desired position in the graphic.

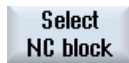

3. Press the "Select NC block" softkey.
The cursor jumps to the associated program block in the editor.

6.15.4 Searching for program blocks

Using the "Search" function, you can go specifically to program blocks where you can edit programs. You can find and replace text in one step.

Precondition

- The required program is opened in the mold making view.
- The "NC blocks" softkey is active.

Procedure

1. Press the "Search" softkey.
A new vertical softkey bar appears.

See also

Searching in programs (Page 174)

Replacing program text (Page 176)

6.15.5 Changing the view

6.15.5.1 Enlarging or reducing the graphical representation

Precondition

- The mold making view has been started.
- The "Graphic" softkey is active.

Procedure



1. Press the <+> and <-> keys if you wish to enlarge or reduce the graphic display.
The graphic display enlarged or reduced from the center.

...



- OR -



Press the "Details" and "Zoom +" softkeys if you wish to increase the size of the segment.



- OR -



Press the "Details" and "Zoom -" softkeys if you wish to decrease the size of the segment.



- OR -



Press the "Details" and "Auto zoom" softkeys if you wish to automatically adapt the segment to the size of the window.



The automatic scaling function "Fit to size" takes account of the largest expansion of the workpiece in the individual axes.

Note

Selected section

The selected sections and size changes are kept as long as the program is selected.

6.15.5.2 Moving and rotating the graphic

Precondition

- The mold making view has been started.
- The "Graphic" softkey is active.

Procedure

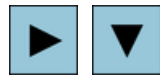

1. Press one of the cursor keys to move the mold making view up, down, left or right.

- OR -



With the <SHIFT> key pressed, rotate the mold building view in the required direction using the cursor keys.



Note

Working with a mouse

Using the mouse, you have the option of rotating and shifting the mold making view.

- To do this, move the graphic with the left-hand mouse key pressed in order to reposition the mold making view.
 - To do this, move the graphic with the right-hand mouse key pressed in order to rotate the mold making view.
-

6.15.5.3 Modifying the viewport

If you want to look at the details, you can shift and change the size of the mold building view section using a magnifying glass.

Using the magnifying glass, you can define your own segment and then increase or decrease its size.

Precondition

- The mold making view has been started.
- The "Graphic" softkey is active.

Procedure



1. Press the "Details" softkey.



2. Press the "Zoom" softkey.

A magnifying glass in the shape of a rectangular frame appears.



3. Press the "Magnify +" or <+> softkey to enlarge the frame.

- OR -



Press the "Magnify -" or <-> softkey to reduce the frame.

- OR -



Press one of the cursor keys to move the frame up, down, left or right.

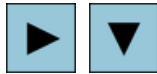

4. Press the "Accept" softkey to accept the section.

6.16 Displaying the program runtime and counting workpieces

To gain an overview of the program runtime and the number of machined workpieces, open the "Times, Counter" window.



Machine manufacturer

Please observe the information provided by the machine manufacturer.

Displayed times

- **Program**
Pressing the softkey the first time shows how long the program has already been running. At every further start of the program, the time required to run the entire program the first time is displayed.
If the program or the feedrate is changed, the new program runtime is corrected after the first run.
- **Program remainder**
Here you can see how long the current program still has to run. In addition, you can follow how much of the current program has been completed in percent on a progress bar. The first program execution differs in the calculation of the additional program executions. When a program is executed for the first time, the progress is estimated based on the program size and the actual program offset. The larger the program and the more linear that it is executed, the more precise the first estimate. This estimate is very inaccurate as a result of the system for programs with steps and/or subprograms.
For each additional program execution, the measured overall program execution time is used as basis for the program progress display.
- **Influencing the time measurement**
The time measurement is started with the start of the program and ends with the end of the program (M30) or with an agreed M function.
When the program is running, the time measurement is interrupted with CYCLE STOP and continued with CYCLE START.
The time measurement starts at the beginning with RESET and subsequent CYCLE START.
The time measurement stops with CYCLE STOP or a feedrate override = 0.

Counting workpieces

You can also display program repetitions and the number of completed workpieces. For the workpiece count, enter the actual and planned workpiece numbers.

Workpiece count

Completed workpieces can be counted via the end of program command (M30) or an M command.

Procedure



1. Select the "Machine" operating area.



2. Press the <AUTO> key.



3. Press the "Times, Counter" softkey.
The "Times, Counter" window opens.



4. Select "Yes" under "Count workpieces" if you want to count completed workpieces.

5. Enter the number of workpieces needed in the "Desired workpieces" field. The number of workpieces already finished is displayed in "Actual workpieces". You can correct this value when required.

After the defined number of workpieces is reached, the current workpieces display is automatically reset to zero.

See also

Entering the number of workpieces (Page 306)

6.17 Setting for automatic mode

Before machining a workpiece, you can test the program in order to identify programming errors at an early stage. Use the dry run feedrate for this purpose.

You have the option of additionally limiting the traversing speed so that when running-in a new program with rapid traverse, no undesirably high traversing speeds occur.

Dry run feedrate

If you selected "DRY run feedrate" under program control, then the value entered in "Dry run feedrate DRY" replaces the programmed feedrate when executing/machining.

Reduced rapid traverse

If you selected "RG0 reduced rapid traverse" under program control, then rapid traverse is reduced to the percentage value entered in "reduced rapid traverse RG0".

Displaying measurement results

Using an MMC command, measurement results can be displayed in a part program:

The following settings are possible:

- When it reaches the command, the control automatically jumps to the "Machine" operating area and the window with the measurement results is displayed
- The window with the measurement results is opened by pressing the "Measurement result" softkey.

Recording machining times

To provide support when creating and optimizing a program, you have the option of displaying the machining times.

You define whether the time is determined while the workpiece is being machined (i.e. if the function is energized).

- Off
Machining times are not determined when machining a workpiece. No machining times are determined.
- Non-modal
The machining times are determined for each traversing block of a main program.
Note: You also have the option of displaying the cumulative times for blocks.
Please observe the information provided by the machine manufacturer.
- Block-by-block
Machining times are determined for all blocks.

Note

Utilization of resources

The more machining times are displayed, the more resources are utilized.

More machining times are determined and saved with the non-modal setting than with the block-by-block setting.

Note

Please observe the information provided by the machine manufacturer.

Saving machining times

You define how the machining times determined are processed.

- Yes
A subdirectory with the name "GEN_DATA.WPD" is created in the directory of the part program. The machining times determined are saved in an ini file in the subdirectory, together with the name of the program.
- No
The machining times that have been determined are only displayed in the program block display.

Procedure



1. Select the "Machine" operating area.



2. Press the <AUTO> key.



3. Press the menu forward key and the "Settings" softkey.
The "Settings for Automatic Operation" window opens.



- 4. In "DRY run feedrate," enter the desired dry run speed.
- 5. Enter the desired percentage in the "Reduced rapid traverse RG0" field.
RG0 has no effect if you do not change the specified amount of 100%.



6. Select the required entry in the "Display measurement result" field:

- "Automatic"
The measurement result window opens automatically.
- "manual"
The measurement result window is to be opened by pressing the "Measurement result" softkey.



7. Select the required entry in the "Record machining times" and in the "Save machining times" field.

References

Programming Manual Measuring Cycles / 840D sl/828D

Note

You have the option of changing the feedrate velocity in operation.

See also

Current block display (Page 48)

Simulating machining

7.1 Overview

During simulation, the current program is calculated in its entirety and the result displayed in graphic form. The result of programming is verified without traversing the machine axes. Incorrectly programmed machining steps are detected at an early stage and incorrect machining on the workpiece prevented.

Graphic display

The simulation uses the correct proportions of the workpiece, tools, chuck, counterspindle and tailstock for the screen display.

For the spindle chuck and the tailstock, dimensions are used that are entered into the "Spindle Chuck Data" window.

For non-cylindrical blanks, the chuck closes up to the contour of the cube or polygon.

Depth display

The depth infeed is color-coded. The depth display indicates the actual depth at which machining is currently taking place. "The deeper, the darker" applies for the depth display.

Definition of a blank

The blank dimensions that are entered in the program editor are used for the workpiece.

The blank is clamped with reference to the coordinate system, which is valid at the time that the blank was defined. This means that before defining the blank in G code programs, the required output conditions must be established, e.g. by selecting a suitable zero offset.

Programming a blank (example)

```
G54 G17 G90
WORKPIECE(,,,"Cylinder",112.0,-50,-80.00,155,100)
T="NC-SPOTDRILL_D16
```

Machine references

The simulation is implemented as workpiece simulation. This means that it is not assumed that the zero offset has already been precisely scratched or is known. In spite of this, unavoidable MCS references are in the programming, such as for example, the tool change point in the MCS, the park position for the counterspindle in the MCS or the position of the counterspindle slide. Depending on the actual zero offset - in the worst case - these MCS references can mean that collisions are shown in the simulation that would not occur for a realistic zero offset - or vice versa, collisions are not shown, which could occur for a realistic zero offset. This is the reason why in ShopTurn programs, in the case of a simulation, the program header

calculates an appropriate zero offset for the main spindle - or where relevant for the counterspindle - from the specified chuck dimensions.

Programmable frames

All frames and zero offsets are taken into account in the simulation.

Note

Manually swiveled axes

Note that swivel movement in simulation and during simultaneous recording is also displayed when the axes are swiveled manually at the start.

Display of the traversing paths

The traversing paths of the tool are shown in color. Rapid traverse is red and the feedrate is green.

Note

Displaying the tailstock

The tailstock is only visible with the option "ShopMill/ShopTurn".



Machine manufacturer

Please also refer to the machine manufacturer's specifications.

References

SINUMERIK Operate (IM9) / SINUMERIK 840D sl Commissioning Manual

Simulation display

You can choose one of the following types of display:

- **Material removal simulation**
During simulation or simultaneous recording you can follow stock removal from the defined blank.
 - **Path display**
You have the option of including the display of the path. The programmed tool path is displayed.
-

Note

Tool display in the simulation and for simultaneous recording

In order that workpiece simulation is also possible for tools that have either not been measured or have been incompletely entered, certain assumptions are made regarding the tool geometry.

For instance, the length of a miller or drill is set to a value proportional to the tool radius so that cutting can be simulated.

Note

Inaccurate display for tools with large radii

The display of the tool cutting edge depends on the radius set in the tool parameters. The greater the radius, the more rounded the cutting edge is displayed in the simulation and further the traversing path (= center point path) is away from the machined contour.

Because of these inaccuracies in the graphic display, it may appear in the simulation that no material is removed during the machining.

Note

Thread turns are not displayed

For thread and drill thread milling, the thread turns are not displayed in the simulation and for simultaneous recording.

Display variants

You can choose between three variants of graphical display:

- **Simulation before machining of the workpiece**
Before machining the workpiece on the machine, you can perform a quick run-through in order to graphically display how the program will be executed.
- **Simultaneous recording before machining of the workpiece**
Before machining the workpiece on the machine, you can graphically display how the program will be executed during the program test and dry run feedrate. The machine axes do not move if you have selected "no axis motion".
- **Simultaneous recording during machining of the workpiece**
You can follow machining of the workpiece on the screen while the program is being executed on the machine.

Views

The following views are available for all three variants:

- Side view
- Half section
- Front view
- 3D view
- 2-window

Note

Simulation in half-section view

The "half-section" view in the simulation allows a more precise observation of the internal turning operations. This view was not conceived for monitoring milling operations. The display of milling operations can lead to excessive simulation times.

Status display

The current axis coordinates, the override, the current tool with cutting edge, the current program block, the feedrate and the machining time are displayed.

In all views, a clock is displayed during graphical processing. The machining time is displayed in hours, minutes and seconds. It is approximately equal to the time that the program requires for processing including the tool change.



Software options

You require the "3D simulation of the finished part" option for the 3D view.

You require the "Simultaneous recording (real-time simulation)" option for the "Simultaneous recording" function.

Determining the program runtime

The program runtime is determined when executing the simulation. The program runtime is temporarily displayed in the editor at the end of the program.

Properties of simultaneous recording and simulation

Traversing paths

For the simulation, the displayed traversing paths are saved in a ring buffer. If this buffer is full, then the oldest traversing path is deleted with each new traversing path.

Optimum display

If simultaneous machining is stopped or has been completed, then the display is again converted into a high-resolution screen. In some cases this is not possible. In this case, the following message is output: "High-resolution image cannot be generated".

Working zone limitation

No working zone limits and software limit switches are effective in the tool simulation.

Start position for simulation and simultaneous recording

During simulation, the start position is converted via the zero offset to the workpiece coordinate system.

The simultaneous recording starts at the position at which the machine is currently located.

Constraint

- Referencing: G74 from a program run does not function.
- Alarm 15110 "REORG block not possible" is not displayed.
- Compile cycles are only partly supported.
- No PLC support.
- Axis containers are not supported.
- Swivel tables with non-swiveling offset vectors are not supported.

Supplementary conditions

- All of the existing data records (tool carrier / TRAORI, TRANSMIT, TRACYL) are evaluated and must be correctly commissioned for correct simulation.
- Transformations with swiveled linear axis (TRAORI 64 - 69) as well as OEM transformations (TRAORI 4096 - 4098) are not supported.
- Changes to the tool carrier or transformation data only become effective after Power On.
- Transformation change and swivel data record change are supported. However, a real kinematic change is not supported, where a swivel head is physically changed.
- The simulation of mold making programs with extremely short block change times can take longer than machining, as the computation time distribution for this application is dimensioned in favor of the machining and to the detriment of simulation.

Example

An example for supported kinematics is a lathe with B axis:

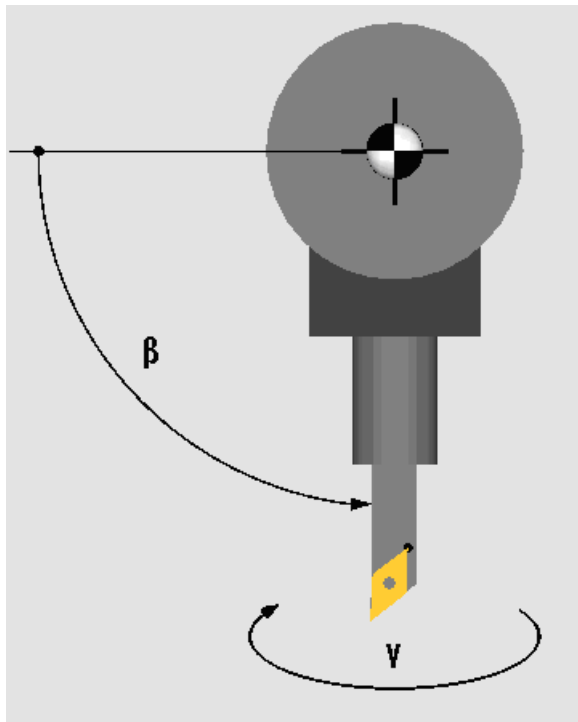

See also

Spindle chuck data (Page 121)

7.2 Simulation before machining of the workpiece

Before machining the workpiece on the machine, you have the option of performing a quick run-through in order to graphically display how the program will be executed. This provides a simple way of checking the result of the programming.

Feedrate override

The rotary switch (override) on the control panel only influences the functions of the "Machine" operating area.

Press the "Program control" softkey to change the simulation feedrate. You can select the simulation feedrate in the range of 0 - 120%.

See also

Changing the feedrate (Page 248)

Simulating the program block by block (Page 249)

Procedure



1. Select the "Program manager" operating area.



2. Select the storage location and position the cursor on the program to be simulated.
3. Press the "Input" or "Cursor right" key.



- OR -

Double-click the required program.

The selected program is opened in the "Program" operating area in the editor.



4. Press the "Simulation" softkey.

The program execution is displayed graphically on the screen. The machine axes do not move.



5. Press the "Stop" softkey if you wish to stop the simulation.



- OR -

Press the "Reset" softkey to cancel the simulation.



6. Press the "Start" softkey to restart or continue the simulation.



Note

Operating area switchover

The simulation is exited if you switch into another operating area. If you restart the simulation, then this starts again at the beginning of the program.



Software option

You require the option "3D simulation of the finished part" for the 3D view.

7.3 Simultaneous recording before machining of the workpiece

Before machining the workpiece on the machine, you can graphically display the execution of the program on the screen to monitor the result of the programming.

You can replace the programmed feedrate with a dry run feedrate to influence the speed of execution and select the program test to disable axis motion.

If you would like to view the current program blocks again instead of the graphical display, you can switch to the program view.



Software option

You require the option "Simultaneous recording (real-time simulation)" for the simultaneous recording.

Procedure



1. Load a program in the "AUTO" mode.
2. Press the "Prog. ctrl." softkey and activate the checkboxes "PRT no axis movement" and "DRY run feedrate".

The program is executed without axis movement. The programmed feedrate is replaced by a dry run feedrate.



3. Press the "Sim. rec." softkey.



4. Press the <CYCLE START> key.

The program execution is displayed graphically on the screen.



5. Press the "Sim. rec." softkey again to stop the recording.

7.4 Simultaneous recording during machining of the workpiece

If the view of the work space is blocked by coolant, for example, while the workpiece is being machined, you can also track the program execution on the screen.



Software option

You require the option "Simultaneous recording (real-time simulation)" for the simultaneous recording.

Procedure



1. Load a program in the "AUTO" mode.
2. Press the "Sim. rec." softkey.



3. Press the <CYCLE START> key.

The machining of the workpiece is started and graphically displayed on the screen.



4. Press the "Sim. rec." softkey again to stop the recording.

Note

- If you switch-on simultaneous recording after the unmachined part information has already been processed in the program, only traversing paths and tool are displayed.
 - If you switch-off simultaneous recording during machining and then switch-on the function again at a later time, then the traversing paths generated in the intermediate time will not be displayed.
-

7.5 Different views of the workpiece

In the graphical display, you can choose between different views so that you constantly have the best view of the current workpiece machining, or in order to display details or the overall view of the finished workpiece.

The following views are available:

- Side view
- Half cut view
- Face view
- 3D view (with option)
- 2-window
- Machine space (with option)

Note

Simulation in half-section view

The "half-section" view in the simulation allows a more precise observation of the internal turning operations. This view was not conceived for monitoring milling operations. The display of milling operations can lead to excessive simulation times.

7.5.1 Side view

Displaying a side view



1. Simultaneous recording or simulation is started.
2. Press the "Side view" softkey.

The side view shows the workpiece in the Z-X plane.

Changing the display

You can increase or decrease the size of the simulation graphic and move it, as well as change the segment.

7.5.2 Half section

Displaying a half cut view



1. Simultaneous recording or simulation is started.
2. Press the "Further views" and "Half cut view" softkeys.

The half cut view shows the workpiece cut in the Z-X plane.

Changing the display

You can increase or decrease the size of the simulation graphic and move it, as well as change the segment.

7.5.3 Face view

Displaying a face view



1. Simultaneous recording or simulation is started.
2. Press the "Further views" and "Face view" softkeys.

The side view shows the workpiece in the X-Y plane.

Changing the display

You can increase or decrease the size of the simulation graphic and move it, as well as change the segment.

7.5.4 3D view

Displaying a 3D view



1. Simultaneous recording or simulation is started.
2. Press the "3D view" softkey.



Software option

You require the option "3D simulation (finished part)" for the simulation.

Changing the display

You can increase or decrease the size of the simulation graphic, move it, turn it, or change the segment.

Displaying and moving cutting planes

You can display and move cutting planes X, Y, and Z.

See also

Defining cutting planes (Page 252)

7.5.5 2-window

Displaying a 2-window view



1. Simultaneous recording or simulation is started.
2. Press the "Further views" and "2 windows" softkeys.

The 2-window view contains a side view (left-hand window) and a front view (right-hand window) of the workpiece. The viewing direction is always from the front to the cutting surface even if machining is to be performed from behind or from the back side.

Changing the display

You can increase or decrease the size of the simulation graphic and move it, as well as change the segment.

7.6 Graphical display

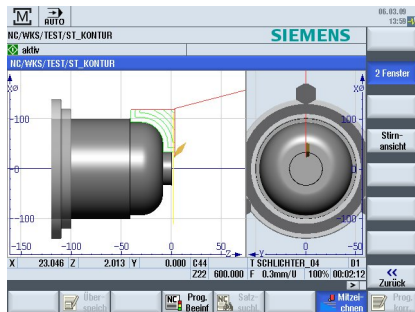

Figure 7-1 2-window view

Active window

The currently active window has a lighter background than the other view windows.

Switch over the active window using the <Next Window> key.

You can change the workpiece display here, e.g. increase or decrease the size, turn it and move it.

Some of the actions that you perform in the active window also have a simultaneous effect in other view windows.

Display of the traversing paths

- Rapid traverse = red
- Feed = green





7.7 Editing the simulation display



7.7.1 Blank display

You have the option of replacing the blank defined in the program or to define a blank for programs in which a blank definition cannot be inserted.

Note

The unmachined part can only be entered if simulation or simultaneous recording is in the reset state.

Parameter	Description	Unit
Main spindle		
Mirroring Z	Mirroring of the Z axis - (only for "data for counterspindle") <ul style="list-style-type: none"> • Yes Mirroring is used when machining on the Z axis • No Mirroring is not used when machining on the Z axis 	
Blank 	Selecting the blank <ul style="list-style-type: none"> • Centered cuboid • Tube • Cylinder • Polygon • without 	
Work offset	Selecting the work offset	
XA	Outside diameter \varnothing - (only for tube and cylinder)	mm
XI 	Inside diameter (abs) or wall thickness (inc) – (only for tube)	mm
W	Width of the blank - (only for centered cuboid)	mm
L	Length of the blank - (only for centered cuboid)	mm
N	Number of edges – (only for polygon)	
SW or L 	Width across flats or edge length – (only for polygon)	mm
ZA	Initial dimension	
ZI 	Final dimension (abs) or final dimension in relation to ZA (inc)	
ZB 	Machining dimension (abs) or machining dimension in relation to ZA (inc)	
Counterspindle		

Parameter	Description	Unit
Mirroring Z	<ul style="list-style-type: none"> • Yes Mirroring is used when machining on the Z axis • No Mirroring is not used when machining on the Z axis 	
Blank 	Selecting the blank <ul style="list-style-type: none"> • Centered cuboid • Tube • Cylinder • Polygon • without 	
XA	Outside diameter \varnothing - (only for tube and cylinder)	
XI 	Inside diameter (abs) or wall thickness (inc) – (only for tube)	mm
W	Width of the blank - (only for centered cuboid)	
N	Number of edges – (only for polygon)	
L	Length of the blank - (only for centered cuboid)	mm
SW or L 	Width across flats or edge length – (only for polygon)	mm
ZI	Blank length (inc)	mm
ZB	Machining dimension (ink)	mm

Procedure

1. The simulation or the simultaneous recording is started.
2. Press the ">>" and "Blank" softkeys.
The "Blank Input" windows opens and displays the pre-assigned values.
3. Enter the desired values for the dimensions.
4. Press the "Accept" softkey to confirm your entries. The newly defined workpiece is displayed.



7.7.2 Showing and hiding the tool path

The path display follows the programmed tool path of the selected program. The path is continuously updated as a function of the tool movement. The tool paths can be shown or hidden as required.

Procedure

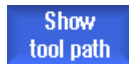

1. The simulation or the simultaneous recording is started.
2. Press the ">>" softkey.
The tool paths are displayed in the active view.
3. Press the softkey to hide the tool paths.
The tool paths are still generated in the background and can be shown again by pressing the softkey again.
4. Press the "Delete tool path" softkey.
All of the tool paths recorded up until now are deleted.

7.8 Program control during the simulation

7.8.1 Changing the feedrate

You have the capability of changing the feedrate at any time during the simulation.

You track the changes in the status bar.

Note

If you are working with the "Simultaneous recording" function, you use the rotary switch (override) on the control panel.

Procedure



1. Simulation is started.
2. Press the "Program control" softkey.
3. Press the "Override +" or "Override -" softkey to increase or decrease the feedrate by 5%, respectively.

- OR -

Press the "100% override" softkey to set the feedrate to 100%.

- OR -

Press the "<<" softkey to return to the main screen and perform the simulation with changed feedrate.

Toggling between "Override +" and "Override -"



Simultaneously press the <Ctrl> and <cursor down> or <cursor up> keys to toggle between the "Override +" and "Override -" softkeys.

Selecting the maximum feedrate





Press the <Ctrl> and <M> keys simultaneously to select the maximum feedrate of 120%.

7.8.2 Simulating the program block by block



You have the capability of controlling the program execution during the simulation, i.e. to execute a program, e.g. program block by program block.

Procedure



1. Simulation is started.
2. Press the "Program control" and "Single block" softkeys.



3. Press the "Back" and "Start SBL" softkeys.

The pending program block is simulated and then stops.



4. Press "Start SBL" as many times as you want to simulate a single program block.

5. Press the "Program control" and the "Single block" softkeys to exist the single block mode.

Switching a single block on and off

- CTRL

S
- Press the <CTRL> and <S> keys simultaneously to enable and disable the single block mode.

7.9 Editing and adapting a simulation graphic

7.9.1 Enlarging or reducing the graphical representation

Precondition

The simulation or the simultaneous recording is started.

Procedure



1. Press the <+> and <-> keys if you wish to enlarge or reduce the graphic display.

The graphic display enlarged or reduced from the center.

...



- OR -



Press the "Details" and "Zoom +" softkeys if you wish to increase the size of the segment.



- OR -



Press the "Details" and "Zoom -" softkeys if you wish to decrease the size of the segment.



- OR -



Press the "Details" and "Auto zoom" softkeys if you wish to automatically adapt the segment to the size of the window.



The automatic scaling function "Fit to size" takes account of the largest expansion of the workpiece in the individual axes.

Note

Selected section

The selected sections and size changes are kept as long as the program is selected.

7.9.2 Panning a graphical representation

Precondition

The simulation or the simultaneous recording is started.

Procedure

1. Press a cursor key if you wish to move the graphic up, down, left, or right.

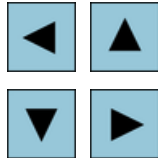

7.9.3 Rotating the graphical representation

In the 3D view you can rotate the position of the workpiece to view it from all sides.

Requirement

The simulation or simultaneous recording has been started and the 3D view is selected.

Procedure

1. Press the "Details" softkey.
2. Press the "Rotate view" softkey.
3. Press the "Arrow right", "Arrow left", "Arrow up", "Arrow down", "Arrow clockwise" and "Arrow counterclockwise" softkeys to change the position of the workpiece.



...



...



- OR -



Keep the <Shift> key pressed and then turn the workpiece in the desired direction using the appropriate cursor keys.

7.9.4 Modifying the viewport

If you would like to move, enlarge or decrease the size of the segment of the graphical display, e.g. to view details or display the complete workpiece, use the magnifying glass.

Using the magnifying glass, you can define your own section and then enlarge or reduce its size.

Precondition

The simulation or the simultaneous recording is started.

Procedure



1. Press the "Details" softkey.



2. Press the "Magnifying glass" softkey.

A magnifying glass in the shape of a rectangular frame appears.



3. Press the "Magnify +" or <+> softkey to enlarge the frame.



- OR -



Press the "Magnify -" or <-> softkey to reduce the frame.



- OR -



Press one of the cursor keys to move the frame up, down, left or right.



4. Press the "Accept" softkey to accept the selected section.

7.9.5 Defining cutting planes

In the 3D view, you have the option of "cutting" the workpiece and therefore displaying certain views in order to show hidden contours.

Precondition

The simulation or the simultaneous recording is started.

Procedure



1. Press the "Details" softkey.



2. Press the "Cut" softkey.



The workpiece is displayed in the cut state.

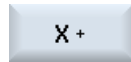

3. Press the corresponding softkey to shift the cutting plane in the required direction.

...

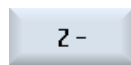

7.10 Displaying simulation alarms

Alarms might occur during simulation. If an alarm occurs during a simulation run, a window opens in the operating window to display it.

The alarm overview contains the following information:

- Date and time
- Deletion criterion
Specifies with which softkey the alarm is acknowledged
- Alarm number
- Alarm text

Precondition

Simulation is running and an alarm is active.

Procedure



1. Press the "Program control" and "Alarm" softkeys.
The "Simulation Alarms" window is opened and a list of all pending alarms is displayed.

Press the "Acknowledge alarm" softkey to reset the simulation alarms indicated by the Reset or Cancel symbol.

The simulation can be continued.

- OR -

Press the "Simulation Power On" softkey to reset a simulation alarm indicated by the Power On symbol.

Creating a G code program

8.1 Graphical programming

Functions

The following functionality is available:

- Technology-oriented program step selection (cycles) using softkeys
- Input windows for parameter assignment with animated help screens
- Context-sensitive online help for every input window
- Support with contour input (geometry processor)

Call and return conditions

- The G functions active before the cycle call and the programmable frame remain active beyond the cycle.
- The starting position must be approached in the higher-level program before the cycle is called. The coordinates are programmed in a clockwise coordinate system.

8.2 Program views

You can display a G code program in various ways.

- Program view
- Parameter screen, either with help screen or graphic view

Note

Help screens / animations

Please note that not all the conceivable kinematics can be displayed in help screens and animations of the cyclic support.

Program view

The program view in the editor provides an overview of the individual machining steps of a program.

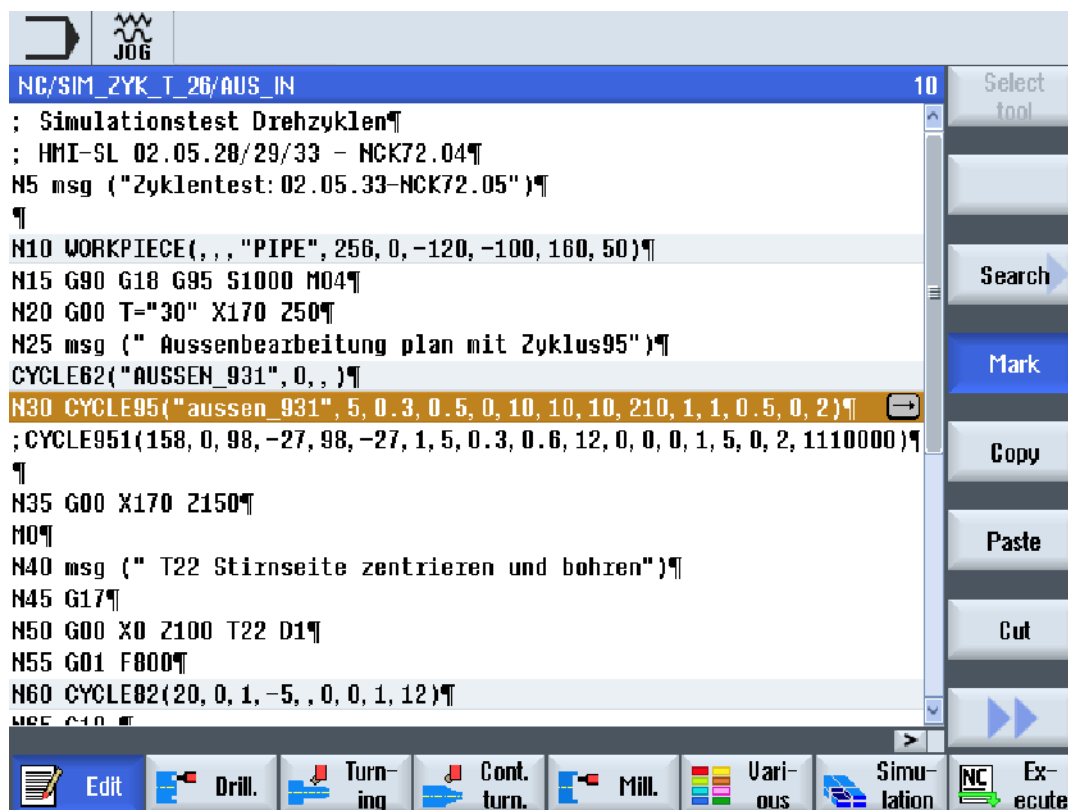
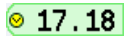
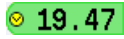
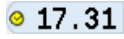
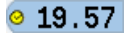
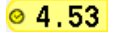

Figure 8-1 Program view of a G code program

Note





In the program editor settings you define as to whether cycle calls are to be displayed as plain text or in NC syntax. You can also configure the recording of the machining times.

Display of the machining times

Display	Meaning
Light green background 	Measured machining time of the program block (automatic mode)
Green background 	Measured machining time of the program block (automatic mode)
Light blue background 	Estimated machining time of the program block (simulation)
Blue background 	Estimated machining time of the program block (simulation)
Yellow background 	Wait time (automatic mode or simulation)

Highlighting of selected G code commands or keywords

In the program editor settings, you can specify whether selected G code commands are to be highlighted in color. The following colors are used as standard:

Display	Meaning
Blue font 	D, S, F, T, M and H functions
Red font 	"G0" motion command
Green font 	"G1" motion command
Blue-green font 	"G2" or "G3" motion command
Gray font 	Comment

Machine manufacturer



You can define further highlight colors in the "sleditorwidget.ini" configuration file. Please refer to the machine manufacturer's specifications.

Synchronization of programs on multi-channel machines

Special commands (e.g. GET and RELEASE) are used on multi-channel machines to synchronize the programs. These commands are marked with a clock symbol.

If the programs of several channels are displayed, the associated commands are displayed in one line.

Display	Meaning
	Synchronization command



In the program view, you can move between the program blocks by pressing the <Cursor up> and <Cursor down> keys.



Parameter screen with help display



Press the <Cursor right> key to open a selected program block or cycle in the program view.

The associated parameter screen with help display is then displayed.

Note

Switching between the help screen and the graphic view

The key combination <CTRL> + <G> is also available for the switchover between the help screen and the graphic view.

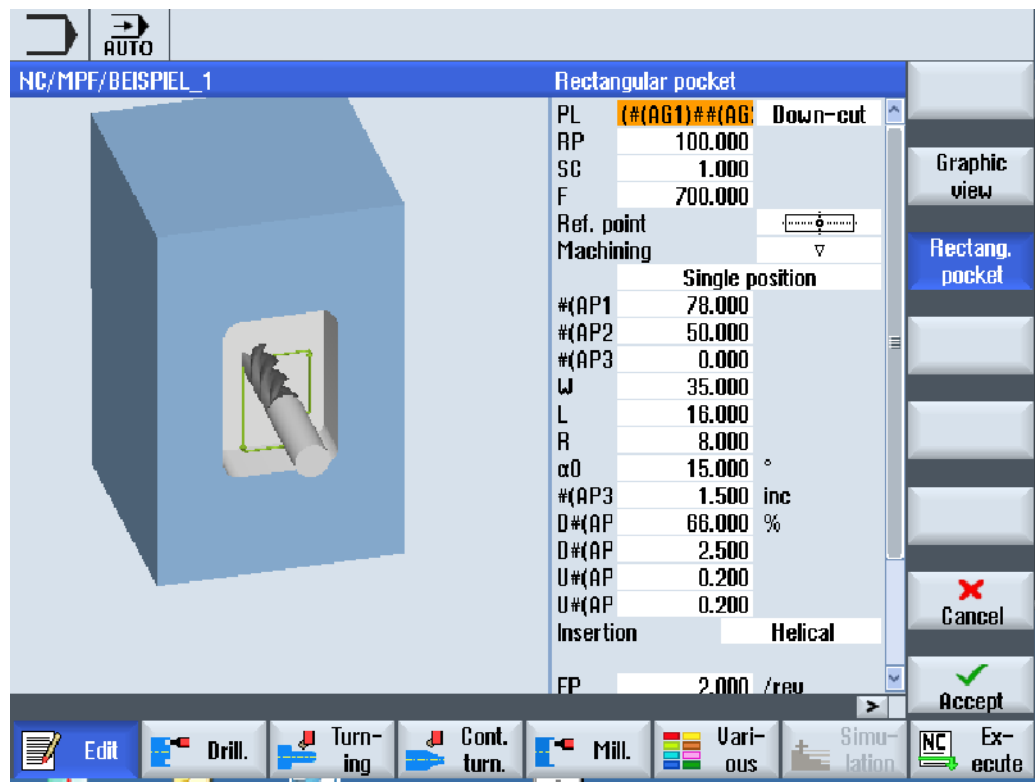

Figure 8-2 Parameter screen with help display

The animated help displays are always displayed with the correct orientation to the selected coordinate system. The parameters are dynamically displayed in the graphic. The selected parameter is displayed highlighted in the graphic.

The colored symbols

Red arrow = tool traverses in rapid traverse

Green arrow = tool traverses with the machining feedrate

Parameter screen with graphic view



Press the "Graphic view" softkey to toggle between the help screen and the graphic view in the screen.

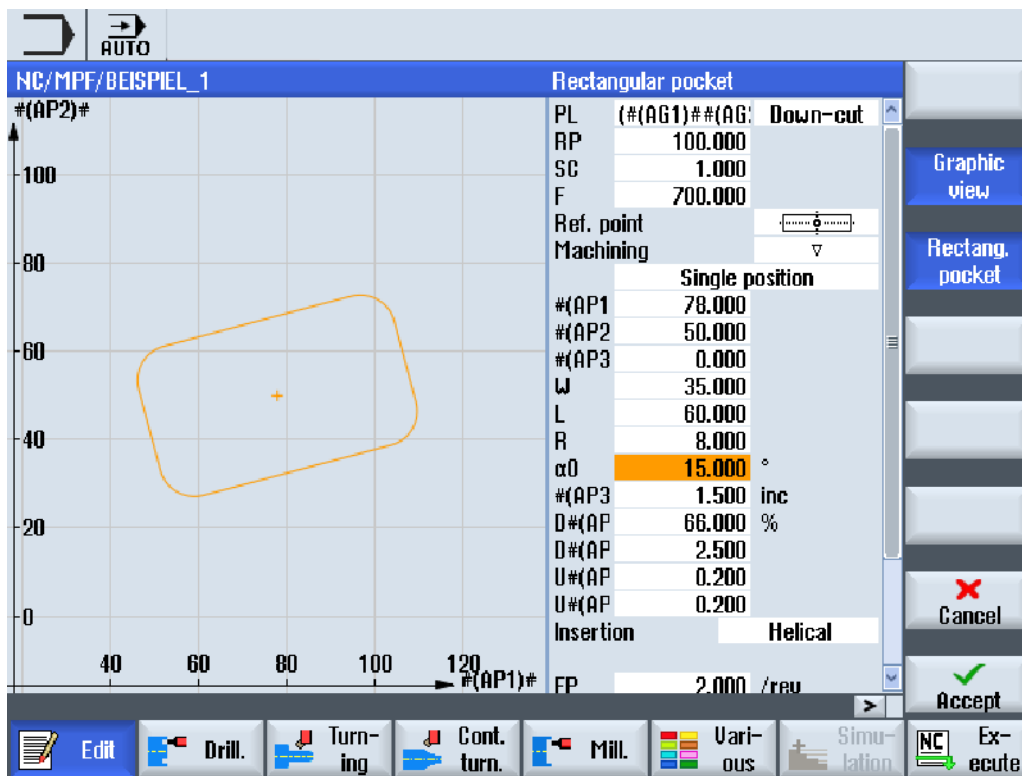

Figure 8-3 Parameter screen with a graphical view of a G code program block

See also

Editor settings (Page 182)

8.3 Program structure

G_code programs can always be freely programmed. The most important commands that are included in the rule:

- Set a machining plane
- Call a tool (T and D)
- Call a work offset
- Technology values such as feedrate (F), feedrate type (G94, G95,...), speed and direction of rotation of the spindle (S and M)
- Positions and calls, technology functions (cycles)
- End of program

For G code programs, before calling cycles, a tool must be selected and the required technology values F, S programmed.

A blank can be specified for simulation.

See also

Blank input (Page 265)

8.4 Fundamentals

8.4.1 Machining planes

A plane is defined by means of two coordinate axes. The third coordinate axis (tool axis) is perpendicular to this plane and determines the infeed direction of the tool (e.g. for 2½-D machining).

When programming, it is necessary to specify the working plane so that the control system can calculate the tool offset values correctly. The plane is also relevant to certain types of circular programming and polar coordinates.

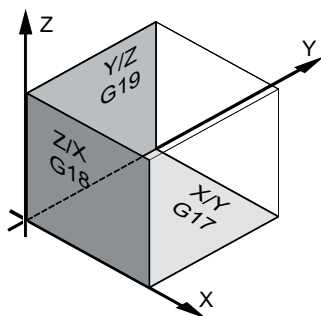

Working planes

Working planes are defined as follows:

Plane		Tool axis
X/Y	G17	Z
Z/X	G18	Y
Y/Z	G19	X

8.4.2 Current planes in cycles and input screens

Each input screen has a selection box for the planes, if the planes have not been specified by NC machine data.

- Empty (for compatibility reasons to screen forms without plane)
- G17 (XY)
- G18 (ZX)
- G19 (YZ)

There are parameters in the cycle screens whose names depend on this plane setting. These are usually parameters that refer to positions of the axes, such as reference point of a position pattern in the plane or depth specification when drilling in the tool axis.

For G17, reference points in the plane are called X0 Y0, for G18 they are called Z0 X0 - and for G19, they are called Y0 Z0. The depth specification in the tool axis for G17 is called Z1, for G18, Y1 and for G19, X1.

If the entry field remains empty, the parameters, the help screens and the broken-line graphics are displayed in the default plane (can be set via machine data):

- Turning: G18 (ZX)
- Milling: G17 (XY)

The plane is transferred to the cycles as new parameter. The plane is output in the cycle, i.e. the cycle runs in the entered plane. It is also possible to leave the plane fields empty and thus create a plane-independent program.

The entered plane only applies for this cycle (not modal)! At the end of the cycle, the plane from the main program applies again. In this way, a new cycle can be inserted in a program without having to change the plane for the remaining program.

8.4.3 Programming a tool (T)

Calling a tool

1. You are in the part program.
2. Press the "Select tool" softkey.
The "Tool selection" window is opened.
3. Position the cursor on the desired tool and press the "To program" softkey.
The selected tool is loaded into the G code editor. Text such as the following is displayed at the current cursor position in the G code editor:
T="ROUGHINGTOOL100"
- OR -
4. Press the "Tool list" and "New tool" softkeys.
5. Then select the required tool using the softkeys on the vertical softkey bar, parameterize it and then press the softkey "To program".
The selected tool is loaded into the G code editor.
6. Then program the tool change (M6), the spindle direction (M3/M4), the spindle speed (S...), the feedrate (F), the feedrate type (G94, G95,...), the coolant (M7/M8) and, if required, further tool-specific functions.



8.5 Generating a G code program

Create a separate program for each new workpiece that you would like to produce. The program contains the individual machining steps that must be performed to produce the workpiece.

Part programs in the G code can be created under the "Workpieces" folder or under the "Part programs" folder.

Procedure



1. Select the "Program Manager" operating area.



2. Select the required archiving location.

Creating a new part program



3. Position the cursor on the folder "Part programs" and press the "New" softkey.



The "New G Code Program" window opens.



4. Enter the required name and press the "OK" softkey.

The name can contain up to 28 characters (name + dot + 3-character extension). You can use any letters (except accented), digits or the underscore symbol (_).

The program type (MPF) is set by default.

The project is created and opened in the Editor.

Creating a new part program for a workpiece



5. Position the cursor on the folder "Workpieces" and press the "New" softkey.



The "New G Code Program" window opens.

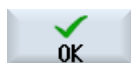

6. Select the file type (MPF or SPF), enter the desired name of the program and press the "OK" softkey.

The project is created and opened in the Editor.

7. Enter the desired G code commands.

See also

Changing a cycle call (Page 274)

Selection of the cycles via softkey (Page 269)

Creating a new workpiece (Page 777)

8.6 Blank input

Function

The blank is used for the simulation and the simultaneous recording. A useful simulation can only be achieved with a blank that is as close as possible to the real blank.

Create a separate program for each new workpiece that you would like to produce. The program contains the individual machining steps that are performed to produce the workpiece.

For the blank of the workpiece, define the shape (tube, cylinder, polygon or centered cuboid) and your dimensions.

Manually reclamping the blank

If the blank is to be manually reclamped from the main spindle to the counterspindle for example, then delete the blank.

Example

- Blank, main spindle, cylinder
- Machining
- M0 : Manually reclamping the blank
- Blank, main spindle, delete
- Blank, counterspindle, cylinder
- Machining

The blank entry always refers to the work offset currently effective at the position in the program.

Note

Swiveling

For programs that use "Swiveling", a 0 swivel must first be made and then the blank defined.

Procedure





1. Select the "Program" operating area.





2. Press the "Misc." and "Blank" softkeys. The "Blank Input" window opens.



8.6 Blank input



Parameter	Description	Unit
Data for	Selection of the spindle for the blank <ul style="list-style-type: none"> • Main spindle • Counterspindle Note: If the machine does not have a counterspindle, then the entry field "Data for" is not applicable.	
Mirroring Z	Mirroring of the Z axis - (only for "data for counterspindle") <ul style="list-style-type: none"> • Yes Mirroring is used when machining on the Z axis • No Mirroring is not used when machining on the Z axis 	
Blank 	Selecting the blank <ul style="list-style-type: none"> • Centered cuboid • Tube • Cylinder • Polygon • Delete 	
ZA	Initial dimension	mm
ZI 	Final dimension (abs) or final dimension in relation to ZA (inc)	mm
ZB 	Machining dimension (abs) or machining dimension in relation to ZA (inc)	mm
Spindle chuck data	<ul style="list-style-type: none"> • Yes You enter spindle chuck data in the program. • No Spindle chuck data are transferred from the setting data. Note: Please observe the machine manufacturer's instructions.	
Spindle chuck data	<ul style="list-style-type: none"> • Only chuck You enter spindle chuck data in the program. • Complete You enter tailstock data in the program. Note: Please observe the machine manufacturer's instructions.	
Jaw type	Selecting the jaw type of the counterspindle. Dimensions of the front edge or stop edge - (only if spindle chuck data "yes") <ul style="list-style-type: none"> • Jaw type 1 • Jaw type 2 	
ZC4	The main spindle chuck dimensions - (only for spindle chuck data "yes")	mm
ZS4	Stop dimension of the main spindle - (only for spindle chuck data "yes")	mm
ZE4	Jaw dimension of the main spindle for jaw type 2 - (only for spindle chuck data "yes")	mm
ZC3	Chuck dimension of the counterspindle - (only for spindle chuck data "yes" and for a counterspindle that has been set up)	mm
ZS3	Stop dimension of the counterspindle - (only for spindle chuck data "yes" and for a counterspindle that has been set up)	mm

Parameter	Description	Unit
ZE3	Jaw dimension of the counterspindle with jaw type 2 - (only for spindle chuck data "yes" and for a counterspindle that has been set up)	mm
XR3	Tailstock diameter - (only for spindle chuck data "complete" and tailstock that has been set up)	mm
ZR3	Tailstock length - (only for spindle chuck data "complete" and tailstock that has been set up)	mm
XA	Outside diameter – (only for tube and cylinder)	mm
XI 	Inside diameter (abs) or wall thickness (inc) – (only for tube)	mm
N	Number of edges – (only for polygon)	
SW or L 	Width across flats or edge length – (only for polygon)	mm
W	Width of the blank - (only for centered cuboid)	mm
L	Length of the blank - (only for centered cuboid)	mm

8.7 Machining plane, milling direction, retraction plane, safe clearance and feedrate (PL, RP, SC, F)

In the program header, cycle input screens have general parameters that always repeat.

You will find the following parameters in every input screen for a cycle in a G code program.

Parameter	Description	Unit
PL 	Each input screen has a selection box for the planes, if the planes have not been specified by NC machine data. Machining plane: <ul style="list-style-type: none"> • G17 (XY) • G18 (ZX) • G19 (YZ) 	
Milling direction  - only for milling	When machining a pocket, a longitudinal slot or a spigot, the machining direction (climbing or conventional) and the spindle direction are taken into account in the tool list. The pocket is then machined in a clockwise or counter-clockwise direction. During path milling, the programmed contour direction determines the machining direction.	
RP	Retraction plane (abs) During machining the tool traverses in rapid traverse from the tool change point to the return plane and then to the safety clearance. The machining feedrate is activated at this level. When the machining operation is finished, the tool traverses at the machining feedrate away from the workpiece to the safety clearance level. It traverses from the safety clearance to the retraction plane and then to the tool change point in rapid traverse. The retraction plane is entered as an absolute value. Normally, reference point Z0 and retraction plane RP have different values. The cycle assumes that the retraction plane is in front of the reference point.	mm
SC 	Safety clearance (inc) The safety clearance specifies from which clearance to the material rapid traverse is no longer used. The direction in which the safety clearance is active is automatically determined by the cycle. Generally, it is effective in several directions. The safety clearance must be entered as an incremental value (without sign).	mm
F	Feedrate The feedrate F (also referred to as the machining feedrate) specifies the speed at which the axes move when machining the workpiece. The unit of the feedrate (mm/min, mm/rev, mm/tooth etc.) always refers to the feedrate type programmed before the cycle call. The maximum feedrate is determined via machine data.	

8.8 Selection of the cycles via softkey

Overview of the machining steps

The following machining steps are available.

All of the cycles/functions available in the control are shown in this display. However, at a specific system, only the steps possible corresponding to the selected technology can be selected.

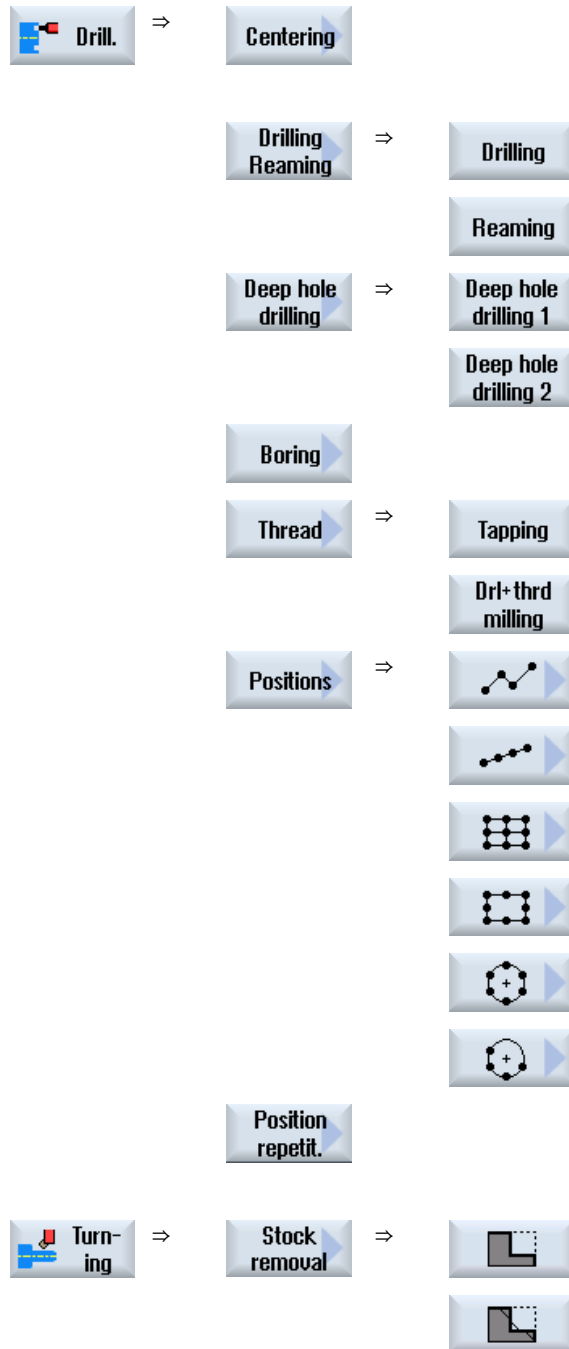

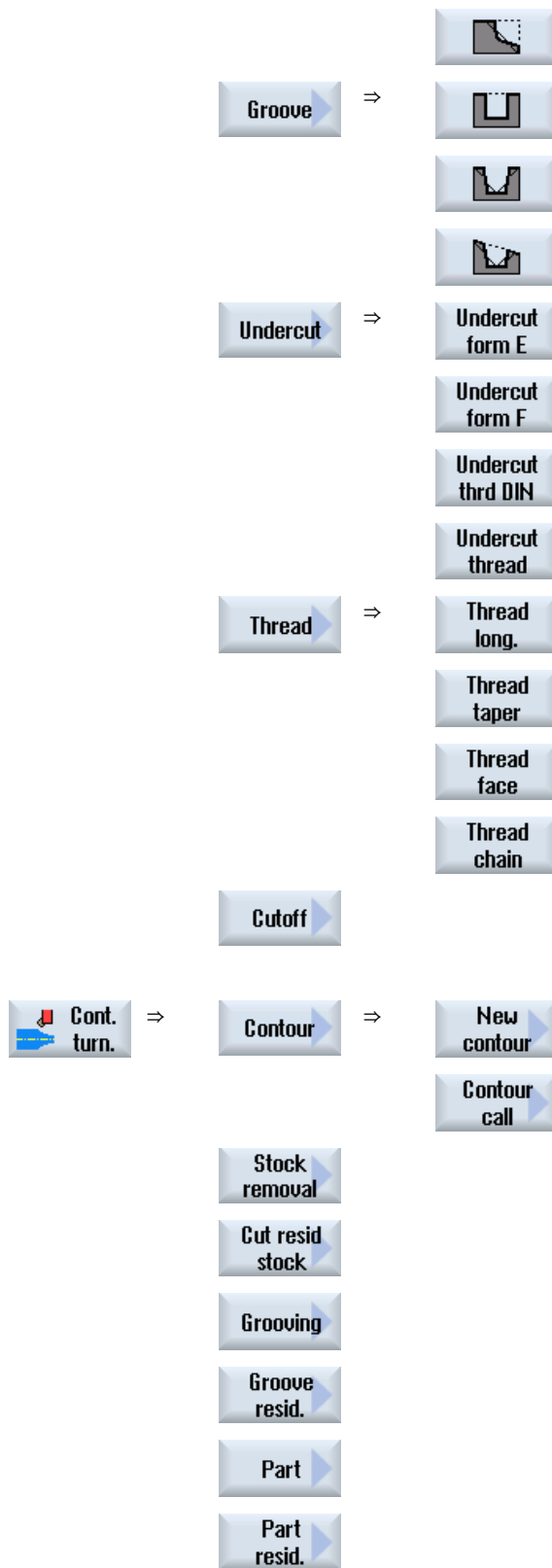

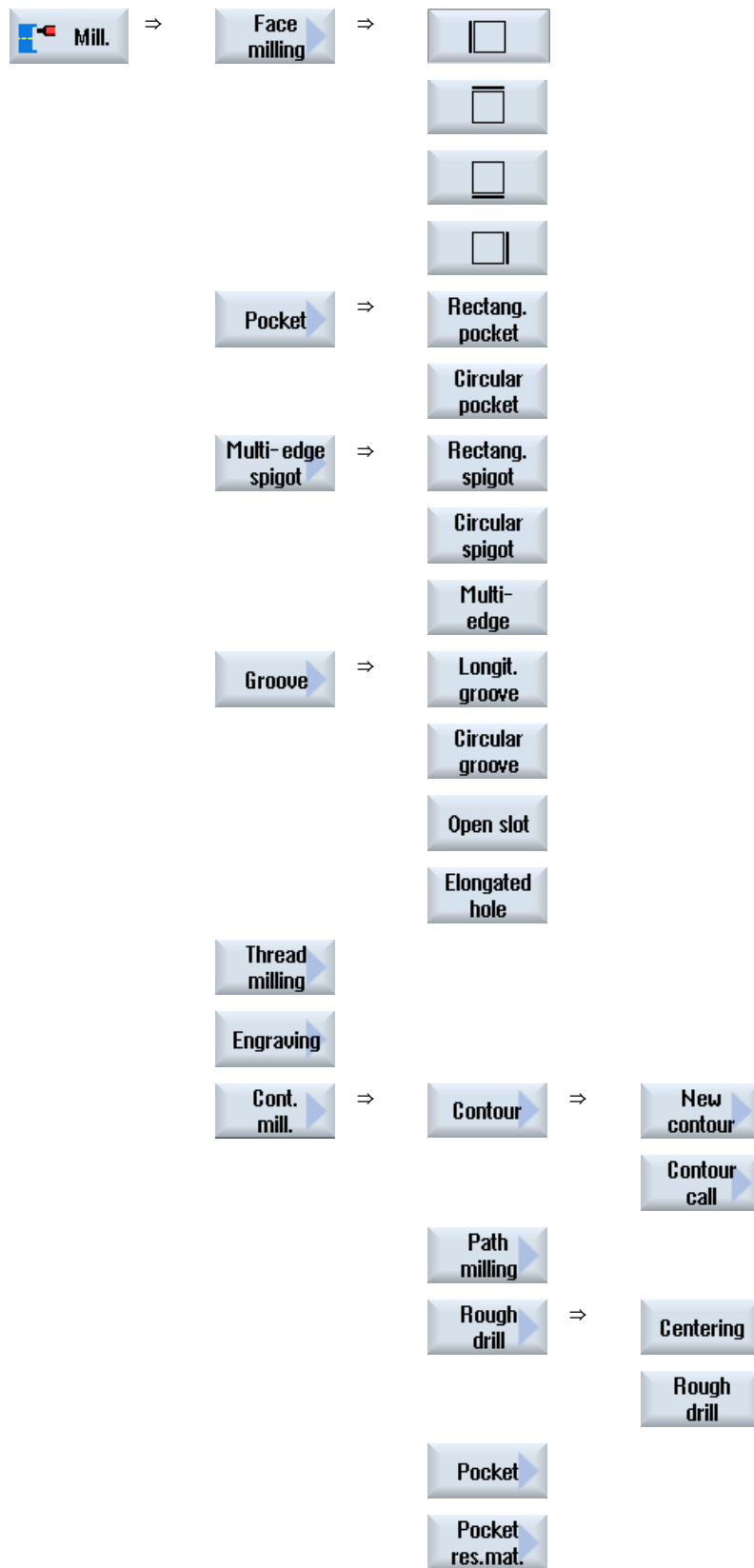

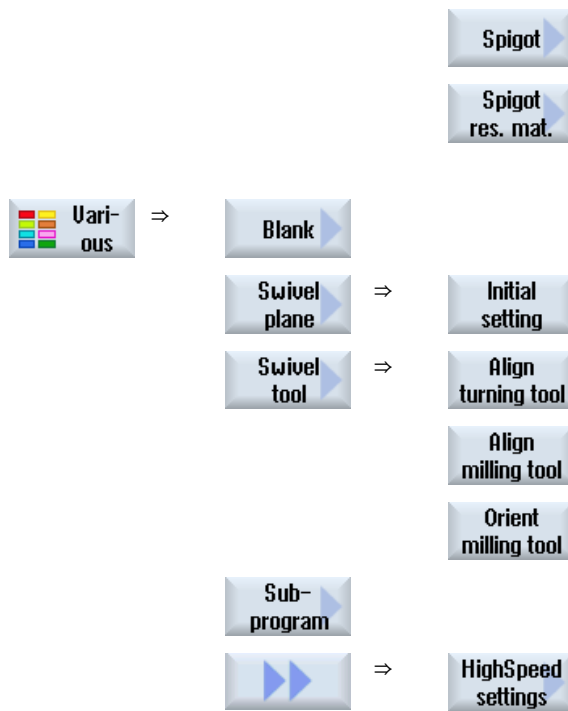

=>

A menu tree with all of the available measuring versions of the measuring cycle function "Measure workpiece" can be found in the following reference:
Programming Manual Measuring cycles / SINUMERIK 840D sl/828D



=>

A menu tree with all of the available measuring versions of the measuring cycle function "Measure tool" can be found in the following reference:
Programming Manual Measuring cycles / SINUMERIK 840D sl/828D

See also

General (Page 339)

Generating a G code program (Page 264)

8.9 Calling technology cycles

8.9.1 Hiding cycle parameters

The documentation describes all the possible input parameters for each cycle. Depending on the settings of the machine manufacturer, certain parameters can be hidden in the screens, i.e. not displayed. These are then generated with the appropriate default values when the cycles are called.

For additional information, please refer to the following references:

SINUMERIK Operate Commissioning Manual

Cycle support

Example



1. Use the softkeys to select whether you want support for programming contours, turning, drilling or milling cycles.



...



2. Select the desired cycle using the softkey in the vertical softkey bar.
3. Enter the parameters and press the "Accept" softkey.

The cycle is transferred to the editor as G code.

8.9.2 Setting data for cycles

Cycle functions can be influenced and configured using machine and setting data.

For additional information, please refer to the following references:

SINUMERIK Operate Commissioning Manual

8.9.3 Checking cycle parameters

The entered parameters are already checked during the program creation in order to avoid faulty entries.

If a parameter is assigned an illegal value, this is indicated in the input screen and is designated as follows:

- The entry field has a colored background (background color, pink).
- A note is displayed in the comment line.
- If the parameter input field is selected using the cursor, the note is also displayed as tooltip.

The programming can only be completed after the incorrect value has been corrected.

Faulty parameter values are also monitored with alarms during the cycle runtime.

8.9.4 Programming variables

In principle, variables or expressions can also be used in the input fields of the screen forms instead of specific numeric values. In this way, programs can be created very flexibly.

Input of variables

Please note the following points when using variables:

- Values of variables and expressions are not checked since the values are not known at the time of programming.
- Variables and expressions cannot be used in fields in which a text is expected (e.g. tool name).
An exception is the "Engraving" function, in which you can assign the desired text in the text field via a variable as "Variable text".
- Selection fields generally cannot be programmed with variables.

Examples

```
VAR_A  
VAR_A+2*VAR_B  
SIN(VAR_C)
```

8.9.5 Changing a cycle call

You have called the desired cycle via softkey in the program editor, entered the parameters and confirmed with "Accept".

Procedure



1. Select the desired cycle call and press the <Cursor right> key.
The associated input screen of the selected cycle call is opened.
- OR -



Press the <SHIFT + INSERT> key combination.

This starts the edit mode for this cycle call and you can edit it like a normal NC block. This means that it is possible to generate an empty block before the cycle is called. For instance, to insert something before a cycle that is located at the beginning of the program.

Note: In edit mode, the cycle call can be changed in such a way that it can no longer be recompiled in the parameter screen.



You exit the edit mode by pressing the <SHIFT + INSERT> key combination.

- OR -



You are in the edit mode and press the <INPUT> key.

A new line is created after the cursor position.

See also

Generating a G code program (Page 264)

8.9.6 Compatibility for cycle support

The cycle support is generally upwards compatible. This means that cycle calls in NC programs can always be recompiled with a higher software version, changed and then run again.

When transferring NC programs to a machine with a lower software version, it cannot be guaranteed, however, that the program will be able to be changed by recompiling cycle calls.

8.9.7 Additional functions in the input screens

Selection of units

-  If, for example, the unit can be switched in a field, this is highlighted as soon as the cursor is positioned on the element. In this way, the operator recognizes the dependency. The selection symbol is also displayed in the tooltip.

Display of abs or inc

The abbreviations "abs" and "inc" for absolute and incremental values are displayed behind the entry fields when a switchover is possible for the field.

Help screens

2D and 3D graphics or sectional views are displayed for the parameterization of the cycles.

Online help

If you wish to obtain more detailed information about certain G code commands or cycle parameters, then you can call a context-sensitive online help.

8.10 Measuring cycle support

Measuring cycles are general subroutines designed to solve specific measurement tasks. They can be adapted to specific problems via parameter settings.



Software option

You require the "Measuring cycles" option to use "Measuring cycles".

References

You will find a more detailed description on how to use measuring cycles in:
Programming Manual Measuring cycles / SINUMERIK 840D sl/828D

Creating a ShopTurn program

9.1 Graphic program control, ShopTurn programs

The program editor offers graphic programming to generate machining step programs that you can directly generate at the machine.



Software option

You require the "ShopMill/ShopTurn" option to generate ShopTurn machining step programs.

Functions

The following functionality is available:

- Technology-oriented program step selection (cycles) using softkeys
- Input windows for parameter assignment with animated help screens
- Context-sensitive online help for every input window
- Support with contour input (geometry processor)

9.2 Program views

You can display a ShopTurn program in various views:

- Work plan
- Graphic view
- Parameter screen, either with help screen or graphic view

Note

Help screens / animations

Please note that not all the conceivable kinematics can be displayed in help screens and animations of the cyclic support.

Work plan

The work plan in the editor provides an overview of the individual machining steps of a program.

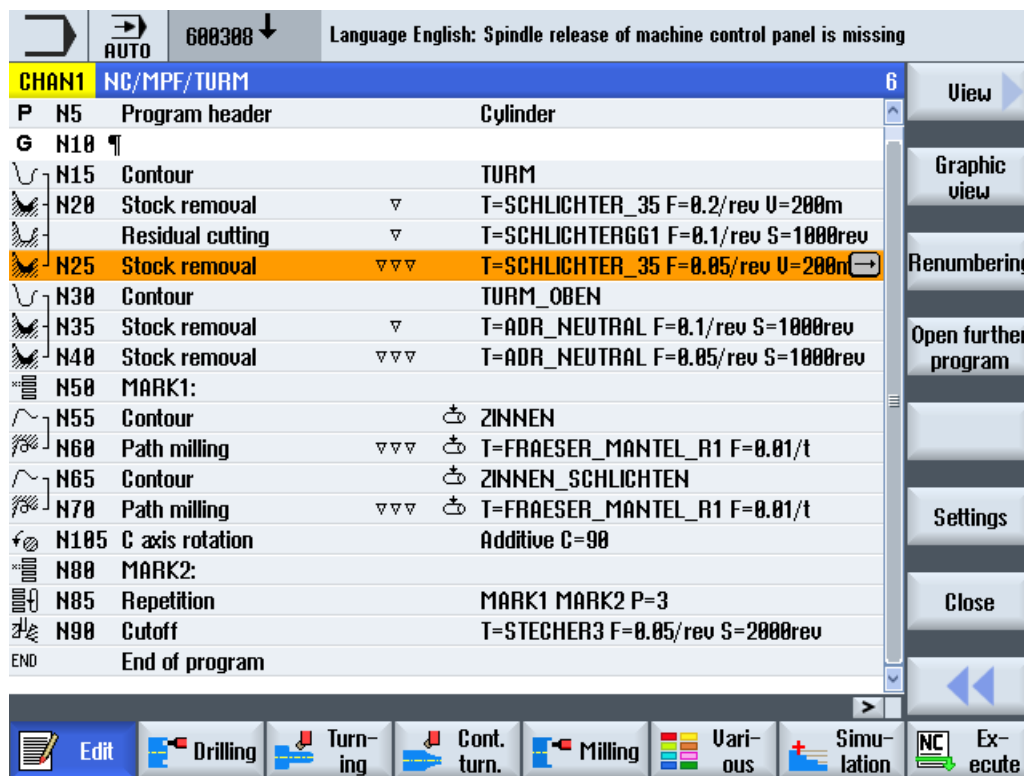
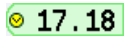
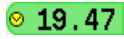
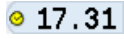
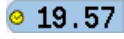
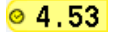

Figure 9-1 Work plan of a ShopTurn program

Note





In the program editor settings, you can specify whether the machining times are to be recorded.

Display of the machining times

Display	Meaning
Light green background 	Measured machining time of the program block (automatic mode)
Green background 	Measured machining time of the program block (automatic mode)
Light blue background 	Estimated machining time of the program block (simulation)
Blue background 	Estimated machining time of the program block (simulation)
Yellow background 	Wait time (automatic mode or simulation)

Highlighting of selected G code commands or keywords

In the program editor settings, you can specify whether selected G code commands are to be highlighted in color. The following colors are used as standard:

Display	Meaning
Blue font 	D, S, F, T, M and H functions
Red font 	"G0" motion command
Green font 	"G1" motion command
Blue-green font 	"G2" or "G3" motion command
Gray font 	Comment

Machine manufacturer



You can define further highlight colors in the "sleditorwidget.ini" configuration file. Please refer to the machine manufacturer's specifications.

Synchronization of programs on multi-channel machines

Special commands (e.g. GET and RELEASE) are used on multi-channel machines to synchronize the programs. These commands are marked with a clock symbol.

If the programs of several channels are displayed, the associated commands are displayed in one line.

Display	Meaning
	Synchronization command

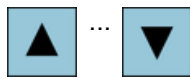

1. You can move between the program blocks in the work plan by pressing the <Cursor up> and <Cursor down> keys.



2. Press the ">>" and "Graphic view" softkeys to display the graphic view.



Note

Switching between the help screen and the graphic view

The key combination <CTRL> + <G> is also available for the switchover between the help screen and the graphic view.

Graphic view

The graphic view shows the contour of the workpiece as a dynamic graphic with broken lines. The program block selected in the work plan is highlighted in color in the graphic view.

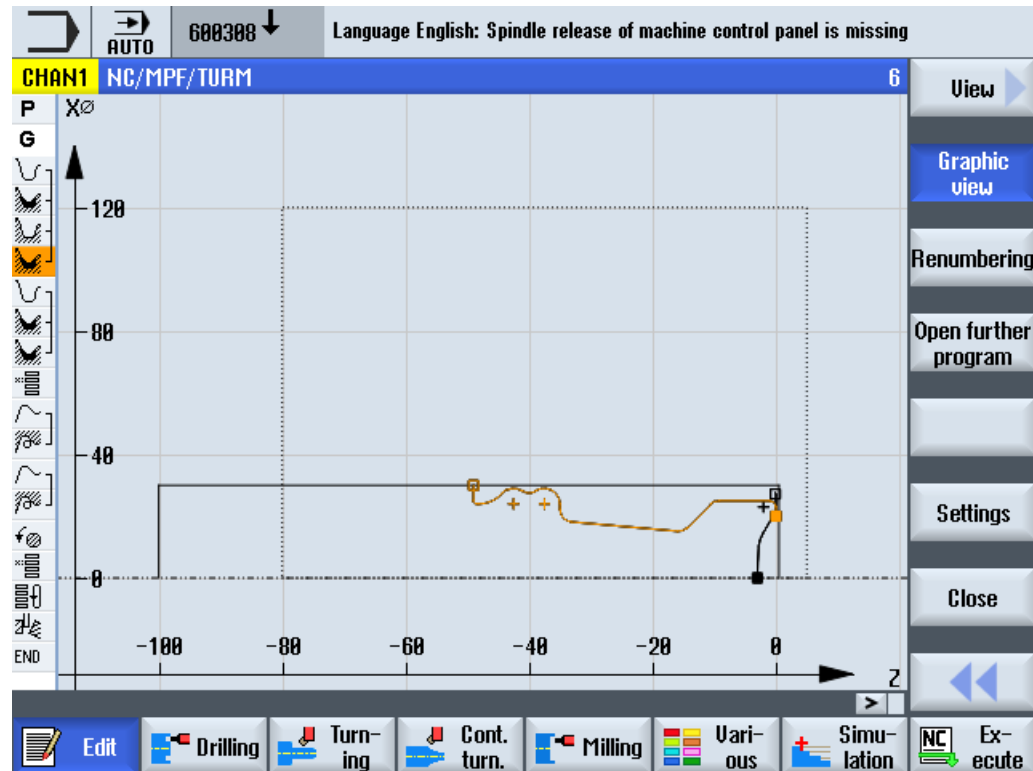

Figure 9-2 Graphic view of a ShopTurn program

Parameter screen with help display and graphic view



1. Press the <Cursor right> key to open a selected program block or cycle in the work plan.
The associated parameter screen with help display is then displayed.



2. Press the "Graphic view" softkey.
The graphic view of the selected program block is displayed.

Note

Switching between the help screen and the graphic view

The key combination <CTRL> + <G> is also available for the switchover between the help screen and the graphic view.

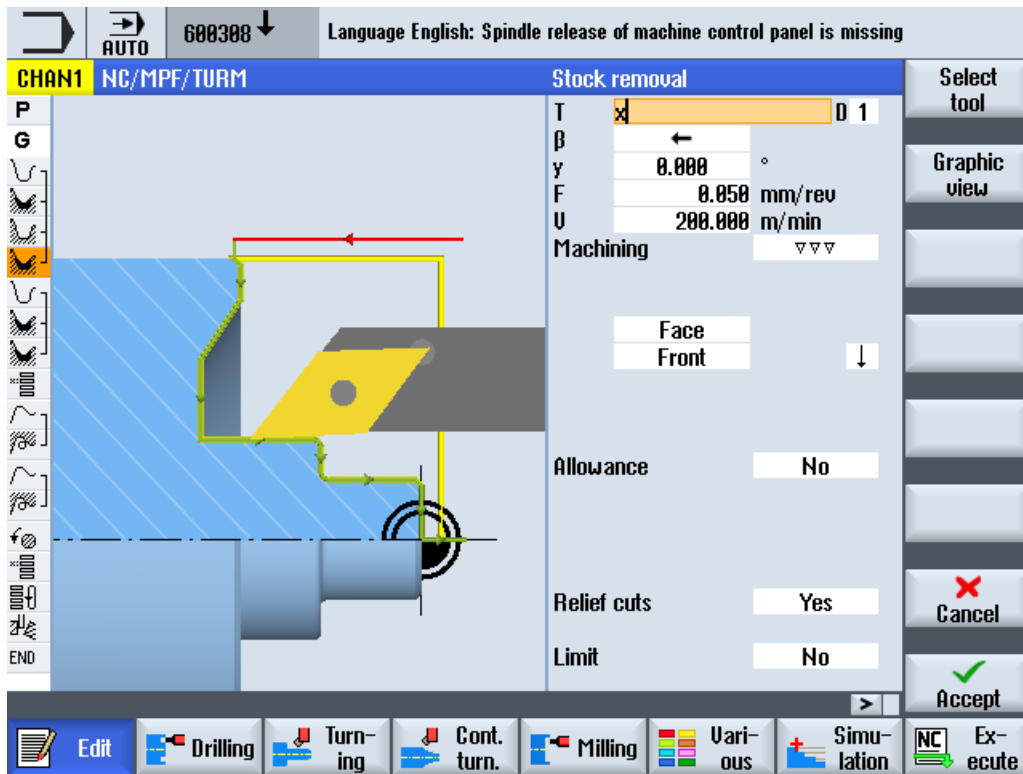

Figure 9-3 Parameter screen with dynamic help display

The animated help displays are always displayed with the correct orientation to the selected coordinate system. The parameters are dynamically displayed in the graphic. The selected parameter is displayed highlighted in the graphic.

Graphic view Press the "Graphic view" softkey to toggle between the help display and the graphic view in the screen.

Note

Switching between the help screen and the graphic view

The key combination <CTRL> + <G> is also available for the switchover between the help screen and the graphic view.

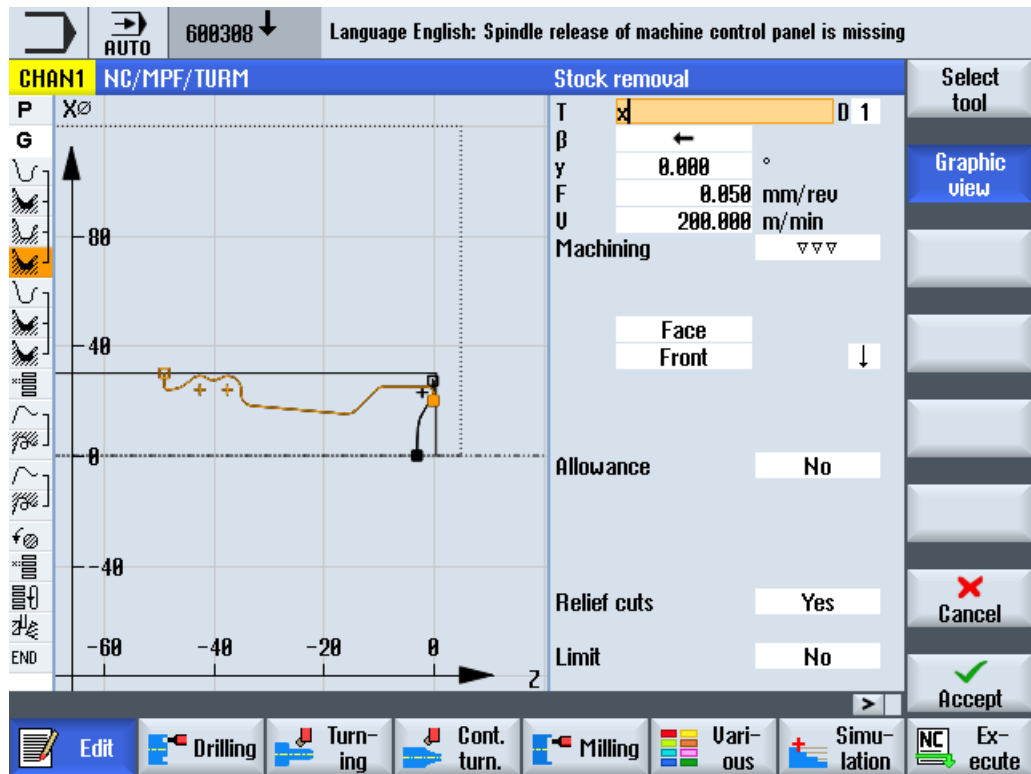

Figure 9-4 Parameter screen with graphic view

9.3 Program structure

A machining step program is divided into three sub-areas:

- Program header
- Program blocks
- End of program

These sub-areas form a process plan.

Program header

The program header contains parameters that affect the entire program, such as blank dimensions or retraction planes.

Program blocks

You determine the individual machining steps in the program blocks. In doing this, you specify the technology data and positions, among other things.

Linked blocks

For the "Contour turning", "Contour milling", "Milling", and "Drilling" functions, program the technology blocks and contours or positioning blocks separately. These program blocks are automatically linked by the control and connected by brackets in the process plan.

In the technology blocks, specify how and in what form the machining should take place, e.g. centering first, and then drilling. In the positioning blocks, determine the positions for the drilling or milling machining, e.g. position the drill-holes in a full circle on the face surface.

End of program

End of program signals to the machine that the machining of the workpiece has ended. Further, here you set whether program execute should be repeated.

Note

Number of workpieces

You can enter the number of required workpieces using the "Times, counters" window.

See also

Entering the number of workpieces (Page 306)

9.4 Fundamentals

9.4.1 Machining planes

A workpiece can be machined on different planes. Two coordinate axes define a machining plane. On lathes with X, Z, and C axes, three planes are available:

- Turning
- Face
- Peripheral surface

Machining planes, face and peripheral surface

The face and peripheral machining planes require the CNC-ISO functions "Face surface machining" (Transmit) and "Cylindrical peripheral transformation" (Tracyl) to be set up.

These functions are a software option.

Additional Y axis

For lathes with an additional Y axis, the machining planes are expanded to include two more planes:

- Face Y
- Peripheral surface Y

Therefore, the face and peripheral planes are called Face C and Peripheral C.

Inclined axis

If the Y axis is an inclined (oblique) axis (i.e. the axis is not perpendicular to the others), you can also select the "Face Y" and "Peripheral Y" machining planes and program the traversing movements in Cartesian coordinates. The control system then automatically transforms the programmed traversing movements of the Cartesian coordinate system into the traversing movements of the inclined (oblique) axis.

The CNC-ISO function "Oblique Axis" (Traang) is required for the purpose of transforming the programmed traversing movements.

This function is a software option.

Selecting the machining plane

The machining plane selection is integrated into the parameter screen forms of the individual drilling and milling cycles. For turning cycles and for "axial drilling" and "axial threads", the turning plane is automatically selected. For the "straight" and "circle" functions, you must specify the machining plane separately.

The settings for the machining plane always act modally, i.e. until you select another plane.

The machining planes are defined as follows:

Turning

The turning machining plane corresponds to the X/Z plane (G18).

Face/Face C

The Face/Face C machining plane corresponds to the X/Y plane (G17). For machines without a Y axis, however, the tools can only move in the X/Z plane. The X/Y coordinates that have been entered are automatically transformed into a movement in the X and C axis.

You can use face surface machining with a C axis for drilling and milling if, for instance, you want to mill a pocket on the face surface. You can choose between the forward or rear face surface for this purpose.

Peripheral surface/Peripheral C

The Peripheral/Peripheral C machining plane corresponds to the Y/Z plane (G19). For machines without a Y axis, however, the tools can only move in the Z/X plane. The Y/Z coordinates that you entered are automatically transformed into a movement in the C and Z axes.

You can use peripheral surface machining with a C axis for drilling and milling if, for instance, you want to mill a slot with constant depth on the peripheral surface. You can choose between the inner or outer surface for this purpose.

Face Y

The face Y machining plane corresponds to the X/Y plane (G17). You can use the face surface machining with a Y axis for drilling and milling if, for instance, you want to mill a pocket on the face surface. You can choose between the forward or rear face surface for this purpose.

With parameter CP, you can define the position of the face surface before machining. CP does not influence the machining position with respect to the workpiece. The parameter only serves to position the workpiece with rotary axis C, so that the workpiece can be machined on the machine. This is required for machines where the traversing path is restricted in the X axis.

Peripheral surface Y

The peripheral Y machining plane corresponds to the Y/Z plane (G19). You can use peripheral surface machining with a Y axis for drilling and milling if, for instance, you want to mill a pocket with a flat base on the peripheral surface or drill holes that do not point to the center. You can choose between the inner or outer surface for this purpose.

Using parameter C0, you can define the position of the surface to be machined with respect to the workpiece itself. Before machining, the workpiece is appropriately positioned using rotary C.

9.4.2 Machining cycle, approach/retraction

Approaching and retracting during the machining cycle always follows the same pattern if you have not defined a special approach/retraction cycle.

If your machine has a tailstock, you can also take this into consideration when traversing.

The retraction for a cycle ends at the safety clearance. Only the subsequent cycle moves to the retraction plane. This enables a special approach/retraction cycle to be used.

Note

When selecting the traversing paths, the tool tip is always taken into account; i.e. the tool expansion is not considered. Therefore, you should ensure that the retraction planes are an appropriate distance away from the workpiece.

Approach/retraction sequence in a machining cycle

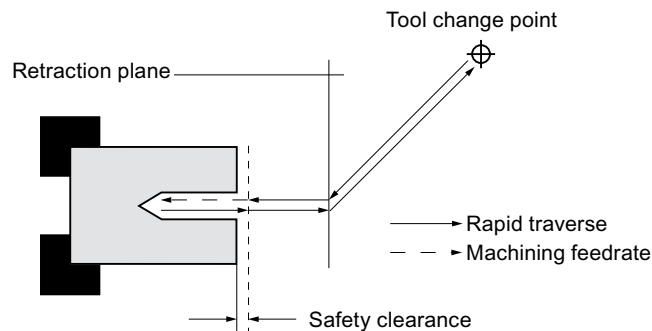

Figure 9-5 Machining cycle, approach/retraction

- The tool traverses in rapid traverse along the shortest path from the tool change point to the retraction plane, which runs parallel to the machining plane.
- After this, the tool traverses in rapid traverse to the safety clearance.
- Following this, the workpiece is then machined with the programmed machining feedrate.
- After machining, the tool retracts with rapid traverse to the safety clearance.
- The tool then continues to traverse vertically in rapid traverse to the retraction plane.
- From there, the tool traverses in rapid traverse along the shortest path to the tool change point. If the tool does not need to be changed between two machining processes, the tool traverses from the retraction plane to the next machining cycle.

The spindle (main, tool, or counter-spindle) begins to rotate immediately after the tool change.

You define the tool change point, the retraction plane, and the safety clearance in the program header.

Taking into account the tailstock

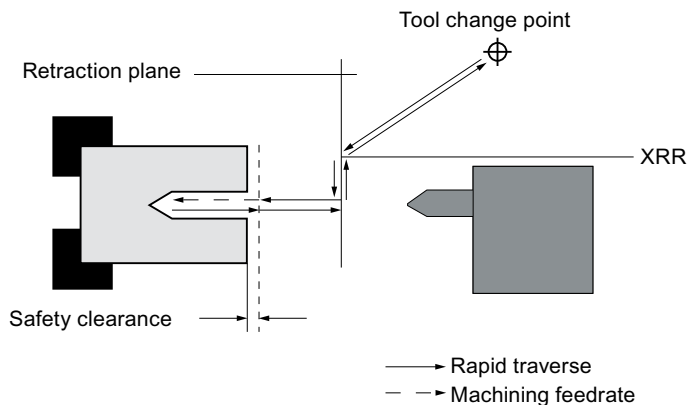

Figure 9-6 Approach/retraction taking into account the tailstock

- The tool traverses in rapid traverse from the tool change point along the shortest path to the retraction plane XRR from the tailstock.
- After this, the tool traverses in rapid traverse on the retraction plane in the X direction.
- After this, the tool traverses in rapid traverse to the safety clearance.
- Following this, the workpiece is then machined with the programmed machining feedrate.
- After machining, the tool retracts with rapid traverse to the safety clearance.
- The tool then continues to traverse vertically in rapid traverse to the retraction plane.
- After this, the tool traverses in the X direction to the retraction plane XRR from the tailstock.
- From there, the tool traverses in rapid traverse along the shortest path to the tool change point. If the tool does not need to be changed between two machining processes, the tool traverses from the retraction plane to the next machining cycle.

You define the tool change point, the retraction plane, the safety clearance, and the retraction plane for the tailstock in the program header.

See also

Programming the approach/retraction cycle (Page 318)

Program header (Page 296)

9.4.3 Absolute and incremental dimensions

When generating a machining step program, you can input positions in absolute or incremental dimensions, depending on how the workpiece drawing is dimensioned.

You can also use a combination of absolute and incremental dimensions, i.e. one coordinate as an absolute dimension and the other as an incremental dimension.

For the face axis (the X axis, in this case), in the machine data it is established whether the diameter or radius is programmed in absolute or incremental dimensions.

Please refer to the machine manufacturer's specifications.

Absolute dimensions (ABS)

With absolute dimensions, all position specifications refer to the zero point of the active coordinate system.

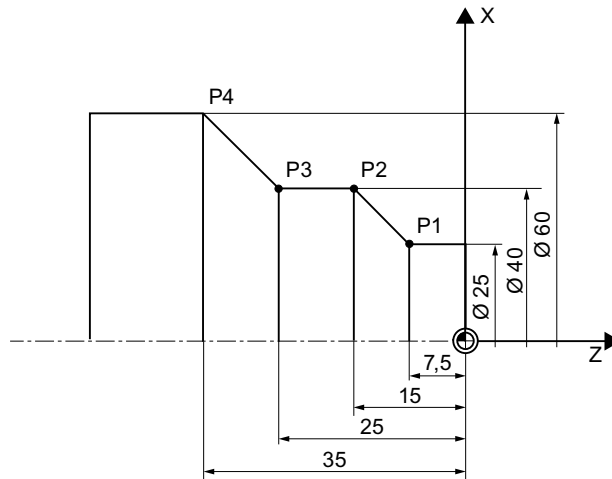

Figure 9-7 Absolute dimensions

The position specifications for the points P1 to P4 in absolute dimensions refer to the zero point:

P1: X25 Z-7.5

P2: X40 Z-15

P3: X40 Z-25

P4: X60 Z-35

Incremental dimensions (INC)

With incremental dimensions (also referred to as sequential dimensions) a position specification refers to the previously programmed point. This means that the input value corresponds to the path to be traversed. As a rule, the plus/minus sign does not matter when entering the incremental value, only the absolute value of the increment is evaluated. For some parameters, the plus/minus sign specifies the traversing direction. These exceptions are identified in the parameter table of the individual functions.

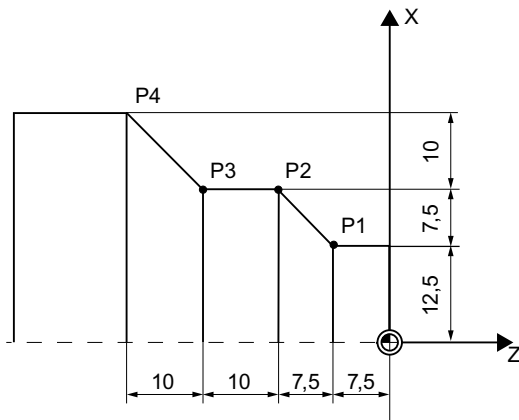

Figure 9-8 Incremental dimensions

The position specifications for points P1 to P4 in incremental dimensions are as follows:

- P1: X12.5 Z-7.5 (relative to the zero point)
- P2: X7.5 Z-7.5 (relative to P1)
- P3:X0 Z-10 (relative to P2)
- P4: X10 Z-10 (relative to P3)

9.4.4 Polar coordinates

You can specify positions using right-angled coordinates or polar coordinates.

If a point in a workpiece drawing is defined by a value for each coordinate axis, you can easily input the position into the parameter screen form using right-angled coordinates. For workpieces that are dimensioned with arcs or angular data, it is often easier if you input the positions using polar coordinates.

You can only program polar coordinates for the functions "Straight circle" and "Contour milling."

The point from which dimensioning starts in polar coordinates is called the "pole".

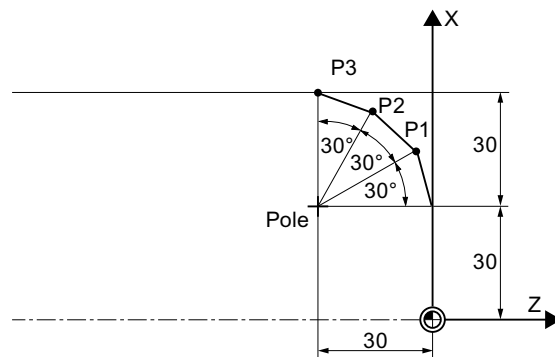

Figure 9-9 Polar coordinates

The position specifications for the pole and points P1 to P3 in polar coordinates are:

Pole: X30 Z30 (relative to the zero point)

P1: L30 α30° (relative to the pole)

P2: L30 α60° (relative to the pole)

P3: L30 α90° (relative to the pole)

9.4.5 Clamping the spindle

The "Clamp spindle" function must be set up by the machine manufacturer.



Machine manufacturer

Please refer to the machine manufacturer's specifications.

Note for selecting the clamp spindle function under ShopTurn

The machine manufacturer also specifies whether ShopTurn will clamp the spindle automatically if this would facilitate machining, or if you can decide the types of machining for which the spindle should be clamped.

If you are to decide the types of machining for which the spindle is to be clamped, the following applies:

You should note that when machining in the end face/end face C and peripheral surface/peripheral surface C planes, clamping only remains active for contour milling and drilling operations. On the other hand, when machining in the end face Y/end face B and peripheral surface Y planes, clamping is modal, i.e. it remains active until the machining plane is changed.

9.5 Creating a ShopTurn program

Create a separate program for each new workpiece that you would like to produce. The program contains the individual machining steps that must be performed to produce the workpiece.

If you create a new program, a program header and program end are automatically defined.

ShopTurn programs can be created in a new workpiece or under the folder "Part programs".

Procedure

Creating a ShopTurn program



1. Select the "Program Manager" operating area.



2. Select the desired storage location and position the cursor on the folder "Part programs" or under the folder "Workpieces" on the workpiece for which you wish to create a program.



3. Press the "New" and "ShopTurn" softkeys. The "New machining step programming" window opens.



4. Enter the required name and press the "OK" softkey. The name can contain up to 28 characters (name + dot + 3-character extension). You can use any letters (except accented), digits or the underscore symbol (_). The "ShopTurn" program type is selected. The editor is opened and the "Program header" parameter screen is displayed.

Filling out the program header



5. Select a work offset.



6. Enter the dimensions of the blank and the parameter, which are effective over the complete program, e.g. dimension units in mm or inch, tool axis, retraction plane, safety clearance and machining direction.

Press the "Teach TC position" softkey if you want to set the actual position of the tool as a tool change point.

The tool's coordinates are transferred into parameters XT and ZT.

Teaching in the tool change point is only possible if you have selected the machine coordinate system (Machine).



7. Press the "Accept" softkey. The work plan is displayed. Program header and end of program are created as program blocks. The end of program is automatically defined.

The retraction for a cycle ends at the safety clearance. Only the subsequent cycle moves to the retraction plane. This enables a special approach/retraction cycle to be used.

Changes to the retraction plane therefore take effect when retracting from the previous machining operation.

When selecting the traversing paths, the tool tip is always taken into account; i.e. the tool expansion is not considered. Therefore, you should ensure that the retraction planes are an appropriate distance away from the workpiece. The retraction planes refer to the workpiece. As a consequence, they are not influenced by a programmable offset.

See also

Creating a new workpiece (Page 777)









Changing program settings (Page 308)

Programming the approach/retraction cycle (Page 318)

9.6 Program header

In the program header, set the following parameters, which are effective for the complete program.

Parameter	Description	Unit
Measurement unit U	The setting of the measurement unit in the program header only refers to the position data in the actual program. All other data, such as feedrate or tool offsets, are entered in the unit of measure that you have set for the entire machine.	mm inch
Work offset U	Selection of the work offset in which the zero point of the workpiece is saved. You can also delete the default value of the parameter if you do not want to specify a work offset.	
Write to the work offset U	Enter the work offset in the program	
	<ul style="list-style-type: none"> No The actual Z value of the selected work offset is used. 	
	<ul style="list-style-type: none"> Yes Enter the work offset in the ZV parameter The actual Z value of the selected work offset is overwritten with the ZV value. 	
ZV	Z value of the work offset of the workpiece	mm
Blank U	Define the form and dimensions of the workpiece:	
	<ul style="list-style-type: none"> Cylinder 	
XA	Outer diameter \varnothing	mm
	<ul style="list-style-type: none"> Polygon 	
N	Number of edges	
SW / L U	Width across flats Edge length	mm
	<ul style="list-style-type: none"> Centered cuboid 	
W	Width of blank	mm
L	Length of blank	mm
	<ul style="list-style-type: none"> Tube 	
XA	Outer diameter \varnothing	mm
XI U	Inner diameter \varnothing (abs) or wall thickness (inc)	mm
ZA	Initial dimension	mm
ZI U	Final dimension (abs) or final dimension in relation to ZA (inc)	mm
ZB	Machining dimension (abs) or machining dimension in relation to ZA (inc)	mm
Retraction U	The retraction area indicates the area outside of which collision-free traversing of the axes must be possible.	
	<ul style="list-style-type: none"> simple 	
XRA U	Retraction plane X external \varnothing (abs) or retraction plane X referred to XA (inc)	mm
XRI U	- only for "pipe" blank Retraction plane X internal \varnothing (abs) or retraction plane X referred to XI (inc)	mm
ZRA U	Retraction plane Z front (abs) or retraction plane Z referred to ZA (inc)	mm

Parameter	Description	Unit
	<ul style="list-style-type: none"> extended - not for a "pipe" blank 	
XRA 	Retraction plane X external \emptyset (abs) or retraction plane X referred to XA (inc)	mm
XRI 	Retraction plane X internal \emptyset (abs) or retraction plane X referred to XI (inc)	mm
ZRA 	Retraction plane Z front (abs) or retraction plane Z referred to ZA (inc)	mm
	<ul style="list-style-type: none"> all 	
XRA 	Retraction plane X external \emptyset (abs) or retraction plane X referred to XA (inc)	mm
XRI 	Retraction plane X internal \emptyset (abs) or retraction plane X referred to XI (inc)	mm
ZRA 	Retraction plane Z front (abs) or retraction plane Z referred to ZA (inc)	mm
ZRI 	Retraction plant Z rear	mm
Tailstock 	<ul style="list-style-type: none"> Yes No 	
XRR	Retraction plane tailstock – (only "Yes" for tailstock)	mm
Tool change point 	<p>Tool change point, which must be approached by the revolver with its zero point.</p> <ul style="list-style-type: none"> WCS (Workpiece Coordinate System) MCS (Machine Coordinate System) <p>Notes</p> <ul style="list-style-type: none"> The tool change point must be far enough outside the retraction area that it is not possible for any tool to protrude into the retraction area while the revolver is moving. Ensure that the tool change point is relative to the zero point of the revolver and not the tool tip. 	
XT	Tool change point X \emptyset	mm
ZT	Tool change point Z	mm
Spindle chuck data	<ul style="list-style-type: none"> Yes You enter spindle chuck data in the program. No Spindle chuck data are transferred from the setting data. <p>Note: Please observe the machine manufacturer's instructions.</p>	
Spindle chuck data	<ul style="list-style-type: none"> Only chuck You enter spindle chuck data in the program. Complete You enter tailstock data in the program. <p>Note: Please observe the machine manufacturer's instructions.</p>	
Jaw type	<ul style="list-style-type: none"> Selecting the jaw type of the counterspindle. Dimensions of the front edge or stop edge - (only if spindle chuck data "yes") Jaw type 1 Jaw type 2 	

9.6 Program header

Parameter	Description	Unit
ZC4	The main spindle chuck dimensions - (only for spindle chuck data "yes")	mm
ZS4	Stop dimension of the main spindle - (only for spindle chuck data "yes")	mm
ZE4	Jaw dimension of the main spindle for jaw type 2 - (only for spindle chuck data "yes")	mm
ZC3	Chuck dimension of the counterspindle - (only for spindle chuck data "yes" and for a counterspindle that has been set up)	mm
ZS3	Stop dimension of the counterspindle - (only for spindle chuck data "yes" and for a counterspindle that has been set up)	mm
ZE3	Jaw dimension of the counterspindle with jaw type 2 - (only for spindle chuck data "yes" and for a counterspindle that has been set up)	mm
XR3	Tailstock diameter - (only for spindle chuck data "complete" and tailstock that has been set up)	mm
ZR3	Tailstock length - (only for spindle chuck data "complete" and tailstock that has been set up)	mm
SC	The safety clearance defines how close the tool can approach the workpiece in rapid traverse. Note Enter the safety clearance without sign into the incremental dimension.	
S	Spindle speed (maximum main spindle speed) If you want to machine the workpiece with a constant cutting rate, the spindle speed must be increased as soon as the workpiece diameter becomes smaller. Since the speed cannot be increased at will, you can set a speed limit for the main spindle (S1) and for the counter-spindle (S3), depending on the shape, size, and material of the workpiece or collet. The machine manufacturer only sets one speed limit for the machine, i.e. none that are dependent on the workpiece. Please refer to the machine manufacturer's specifications.	rev/min
Mach. direction of rotation 	Milling direction <ul style="list-style-type: none"> • Conventional milling • Climbing 	
Z3W	Machining position of the counter spindle in the MCS.	mm

9.7 Generating program blocks

After a new program is created and the program header is filled out, define the individual machining steps in program blocks that are necessary to machine the workpiece.

You can only create the program blocks between the program header and the program end.

Procedure

Selecting a technological function



1. Position the cursor in the work plan on the line behind which a new program block is to be inserted.
2. Using the softkeys, select the desired function.
The associated parameter screen is displayed.

...



3. First, program the tool, correction (offset) value, feedrate and spindle speed (T, D, F, S, V) and then enter the values for the other parameters.

Selecting a tool from the tool list



4. Press the "Select tools" softkey if you wish to select the tool for parameter "T".
The "Tool selection" window is opened.



5. Position the cursor in the tool list on the tool that you wish to use for machining and press the "To program" softkey.
The selected tool is accepted into the parameter screen form.

- OR -



Press the "Tool list" and "New tool" softkeys.
The "Tool selection" window is opened.



Using the softkeys on the vertical softkey bar, select the required tool with the data and press the "To program" softkey.

The selected tool is accepted into the parameter screen form.

The process plan is displayed and the newly generated program block is marked.

9.8 Tool, offset value, feedrate and spindle speed (T, D, F, S, V)

The following parameters should be entered for every program block.

Tool (T)

Each time a workpiece is machined, you must program a tool. Tools are selected by name, and the selection is integrated in all parameter screen forms of the machining cycles (with the exception for straight line/circle).

The tool length offsets become active as soon as the tool is changed.

Tool selection is modal for the straight line/circle, i.e. if the same tool is used to perform several machining steps in succession, you only have to program one tool for the first straight line/circle.

Cutting edge (D)

In the case of tools with several cutting edges, there is a separate set of individual tool offset data for each edge. For these tools, you must select or specify the number of the cutting edge that you would like to use for machining.

NOTICE





Risk of collision

If, for tools with several cutting edges, you specify the incorrect cutting edge number and move the tool, then collisions can occur. Always ensure that you enter the correct cutting edge number.

Radius compensation

The tool radius compensation is automatically taken into account during all machining cycles, with the exception of path milling and straight.

For path milling and straight lines, you have the option of programming the machining with or without radius compensation. The tool radius compensation is modal for straight lines, i.e. you have to deselect the radius compensation again if you want to traverse without radius compensation.

-  Radius compensation to right of contour
-  Radius compensation to left of contour
-  Radius compensation off
-  Radius compensation remains as previously set

Feedrate (F)

The feedrate F (also referred to as the machining feedrate) specifies the speed at which the axes move when machining the workpiece. The machining feedrate is entered in mm/min, mm/rev or in mm/tooth.

It is only possible to enter the feedrate in mm/tooth during milling; this ensures that each cutting edge of the milling cutter is cutting under the best possible conditions. The feedrate per tooth corresponds to the linear path traversed by the milling cutter when a tooth is engaged.

For milling and turning cycles, the feedrate during roughing is relative to the milling or cutting center point. This also applies to finishing, with the exception of contours with inner curves. In this case, the feedrate is relative to the contact point between the tool and the workpiece.

The maximum feedrate is determined via machine data.



Machine manufacturer

Please refer to the machine manufacturer's specifications.

Converting the feedrate (F) for drilling and milling

The feedrate entered for drilling cycles is automatically converted when switching from mm/min to mm/rev and vice versa using the selected tool diameter.

The feedrate entered for milling cycles is automatically converted when switching from mm/Z to mm/min and vice versa using the selected tool diameter.

Spindle speed (S)

The spindle speed S specifies the number of spindle revolutions per minute (rpm) and is programmed along with a tool. The speed specified relates to the main spindle (S1) or counter-spindle (S3) when turning and axial drilling, and to the tool spindle (S2) when drilling and milling.

The spindle starts immediately after the tool change. The spindle stops upon reset, program end, or a tool change. The spindle's direction of rotation is specified in the tool list for each tool.

Cutting rate (V)

The cutting rate V is a circumferential velocity (m/min) and is programmed together with a tool, as an alternative to the spindle speed. The cutting rate is relative to the main spindle (V1) or the counter-spindle (V3) for turning and axial drilling, and corresponds to the circumferential velocity of the workpiece at the point that is currently being machined.

However, for drilling and milling, the cutting rate is relative to the tool spindle (V2) and corresponds to the peripheral speed at which the cutting edge of the tool machines the workpiece.

Converting the spindle speed (S) / cutting rate (V) when milling

As an alternative to the cutting rate, you can also program the spindle speed.

For the milling cycles, the cutting rate (m/min) that is entered is automatically converted into the spindle speed (rpm) using the tool diameter - and vice versa.

Machining

When machining some cycles, you can choose between roughing, finishing, or complete machining. For certain milling cycles, finishing edge or finishing base are possible.

- Roughing
One or more machining operations with depth infeed
- Finishing
Single machining operation
- Edge finishing
Only the edge of the object is finished
- Base finishing
Only the base of the object is finished
- Complete machining

Roughing and finishing with one tool in a

- machining step
If you want to rough and finish using two different tools, you must call the machining cycle twice (1st block = roughing; 2nd block = finishing). The programmed parameters are retained when the cycle is called for the second time.

9.9 Call work offsets

You can call work offsets (G54, etc.) from any program.

You define work offsets in work offset lists. You can also view the coordinates of the selected offset here.

Procedure



1. Press the "Various", "Transformations" and "Work offset" softkeys.
The "Work offset" window opens.
2. Select the desired work offset (e.g. G54).
3. Press the "Accept" softkey.
The work offset is transferred into the work plan.

9.10 Repeating program blocks

If certain steps when machining a workpiece have to be executed more than once, it is only necessary to program these steps once. You have the option of repeating program blocks.

Note

Machining several workpieces

The program repeat function is not suitable to program repeat machining of parts.

In order to repeatedly machine the same workpieces, program this using "end of program".

Start and end marker







You must mark the program blocks that you want to repeat with a start and end marker. You can then call these program blocks up to 200 times within a program. The markers must be unique, i.e. they must have different names. No names used in the NCK can be used.

You can also set markers and repeats after creating the program, but not within linked program blocks.

Note

You can use one and the same marker as end marker for preceding program blocks and as start marker for following program blocks.

Procedure

1. Position the cursor at the program block, behind which a program block that will be repeated should follow.
2. Press the "Various" softkey.

3. Press the ">>" and "Repeat progr." softkeys.

4. Press the "Set marker" and "Accept" softkeys. A start marker is inserted behind the actual block.

5. Enter the program blocks that you want to repeat later.
6. Press the "Set marker" and "Accept" softkeys again. An end marker is inserted after the actual block.



7. Continue programming up to the point where you want to repeat the program blocks.



8. Press the "Various" and "Repeat progr." softkeys.



9. Enter the names of the start and end markers and the number of times the blocks are to be repeated.



10. Press the "Accept" softkey.
The marked program blocks are repeated.

9.11 Entering the number of workpieces

If you wish to produce a certain quantity of the same workpiece, then at the end of the program, specify that you wish to repeat the program.

If your machine has a bar loader for example, you can program the reloading of the workpiece and then the actual machining at the beginning of the program. At the end, cut off the completed workpiece.

Control the numbers of times that the program is repeated using the "Times, counters" window. Enter the number of required workpieces using the target number. You can track the number of machined and completed workpieces in the actual counter window.

Workpieces can be completely automatically produced in this fashion.

Controlling program repetition

End of program: Repeat	Times, counter: Counts the workpieces	
No	No	A CYCLE START is required for each workpiece.
No	Yes	A CYCLE START is required for each workpiece. The workpieces are counted.
Yes	Yes	The program is repeated without a new CYCLE START until the required number of workpieces have been machined.
Yes	No	Without a new CYCLE START, the program is repeated an infinite number of times. You can interrupt program execution with <RESET>.

Procedure

1. Open the "Program end" program block, if you want to machine more than one workpiece.
2. In the "Repeat" field, enter "Yes".
3. Press the "Accept" softkey.



If you start the program later, program execution is repeated.

Depending on the settings in the "Times, counters" window, the program is repeated until the set number of workpieces has been machined.

See also

Displaying the program runtime and counting workpieces (Page 225)

9.12 Changing program blocks

You can subsequently optimize the parameters in the programmed blocks or adapt them to new situations, e.g. if you want to increase the feedrate or shift a position. In this case, you can directly change all the parameters in every program block in the associated parameter screen form.

Procedure



1. Select the program that you wish to change in the "Program Manager" operating area.



2. Press the <Cursor right> or <INPUT> key.
The work plan of the program is displayed.



3. Position the cursor in the work plan at the desired program block and press the <Cursor right> key.
The parameter screen for the selected program block is displayed.



4. Make the desired changes.
5. Press the "Accept" softkey.

- OR -



Press the <Cursor left> key.

The changes are accepted in the program.

9.13 Changing program settings

Function

All parameters specified in the program header with the exception of the blank shape and the unit of measurement can be changed at any point in the program. It is also possible to change the basic setting for the direction of rotation of machining in the case of milling.

The settings in the program header are retentive, i.e. they remain active until they are changed.

Retraction

A changed retraction plane takes effect starting with the safety clearance of the last cycle, because the additional retraction from the next cycle is accepted.

Machining direction of rotation

The machining direction of rotation (climbing or conventional) is defined as the direction of movement of the milling tooth with respect to the workpiece. This means ShopTurn evaluates this parameter in conjunction with the direction of rotation of the spindle for milling, with the exception of path milling.

The basic setting for the machining direction is programmed in a machine data.



Machine manufacturer

Please refer to the machine manufacturer's specifications.

Procedure









1. Select the "Program" operating area.



2. Press the "Various" and "Settings" softkeys. The "Settings" input window opens.



Parameters

Parameter	Description	Unit
Retraction 	Lift mode <ul style="list-style-type: none"> • simple • Extended • all 	
XRA 	Retraction plane X external \emptyset (abs) or retraction plane X referred to XA (inc)	mm
XRI 	Retraction plane X internal \emptyset (abs) or retraction plane X referred to XI (inc) - (only for retraction "extended" and "all")	mm
ZRA 	Retraction plane Z front (abs) or retraction plane Z referred to ZA (inc)	mm
ZRI	Retraction plane Z rear – (only for retraction "all")	mm
Tailstock 	Yes <ul style="list-style-type: none"> • Tailstock is displayed for simulation / simultaneous recording • When approaching/retracting, the retraction logic is taken into account No	
XRR	Retraction plane – (only "Yes" for tailstock)	mm
Tool change point 	Tool change point <ul style="list-style-type: none"> • Work (Workpiece Coordinate System) • Machine (Machine Coordinate System) 	
XT	Tool change point X	mm
ZT	Tool change point Z	mm
SC	Safety clearance (inc) Acts in relation to the reference point. The direction in which the safety clearance is active is automatically determined by the cycle.	mm
S1	Maximum speed, main spindle	rev/min
Machining direction 	Milling direction: <ul style="list-style-type: none"> • Climbing • Conventional 	

9.14 Selection of the cycles via softkey

Overview of the machining steps

The following machining steps are available.

All of the cycles/functions available in the control are shown in this display. However, at a specific system, only the steps possible corresponding to the selected technology can be selected.



Drilling cycles only for turning/milling machine

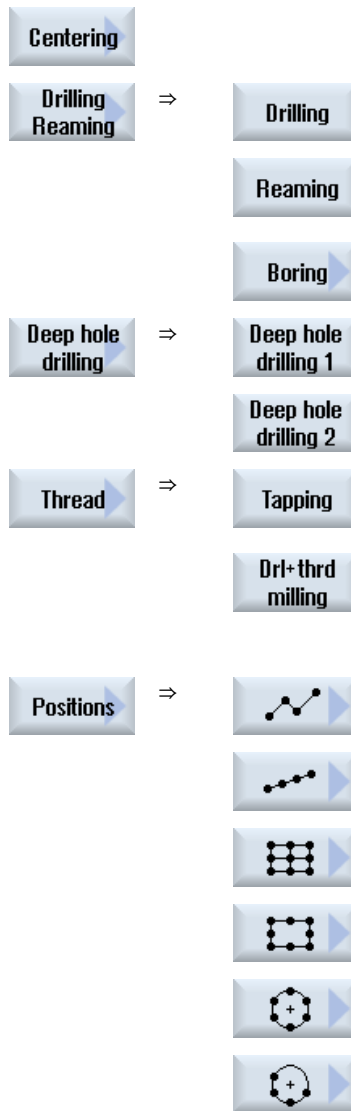

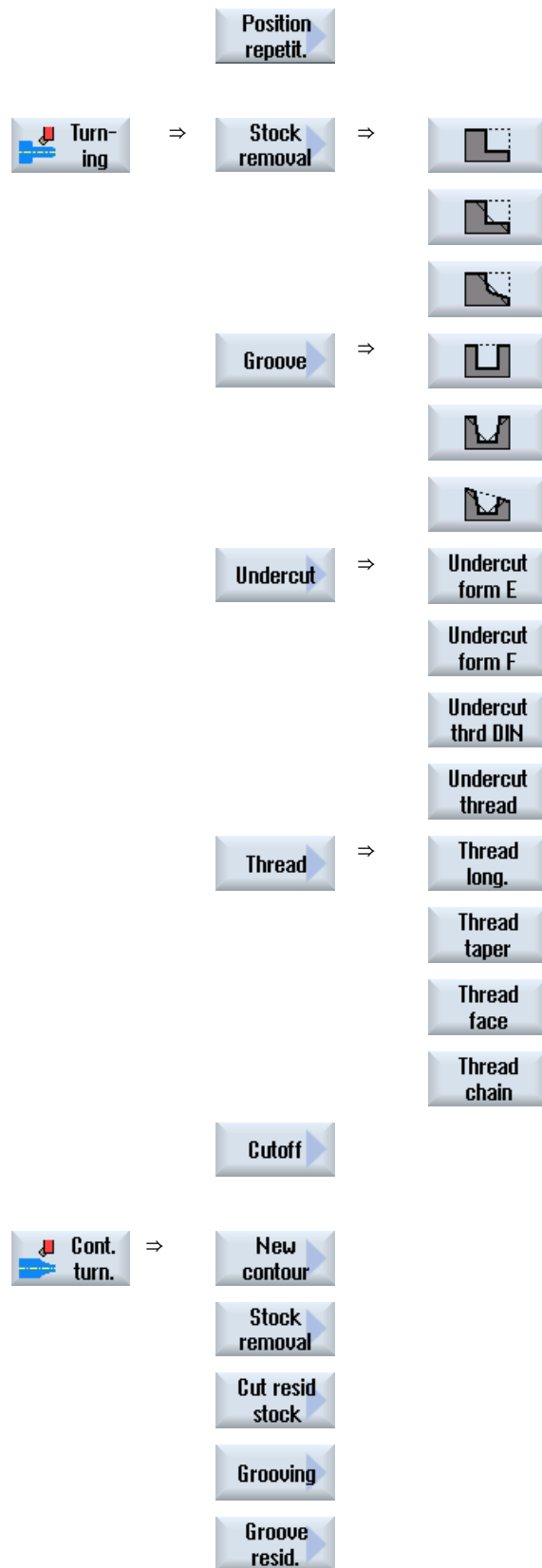

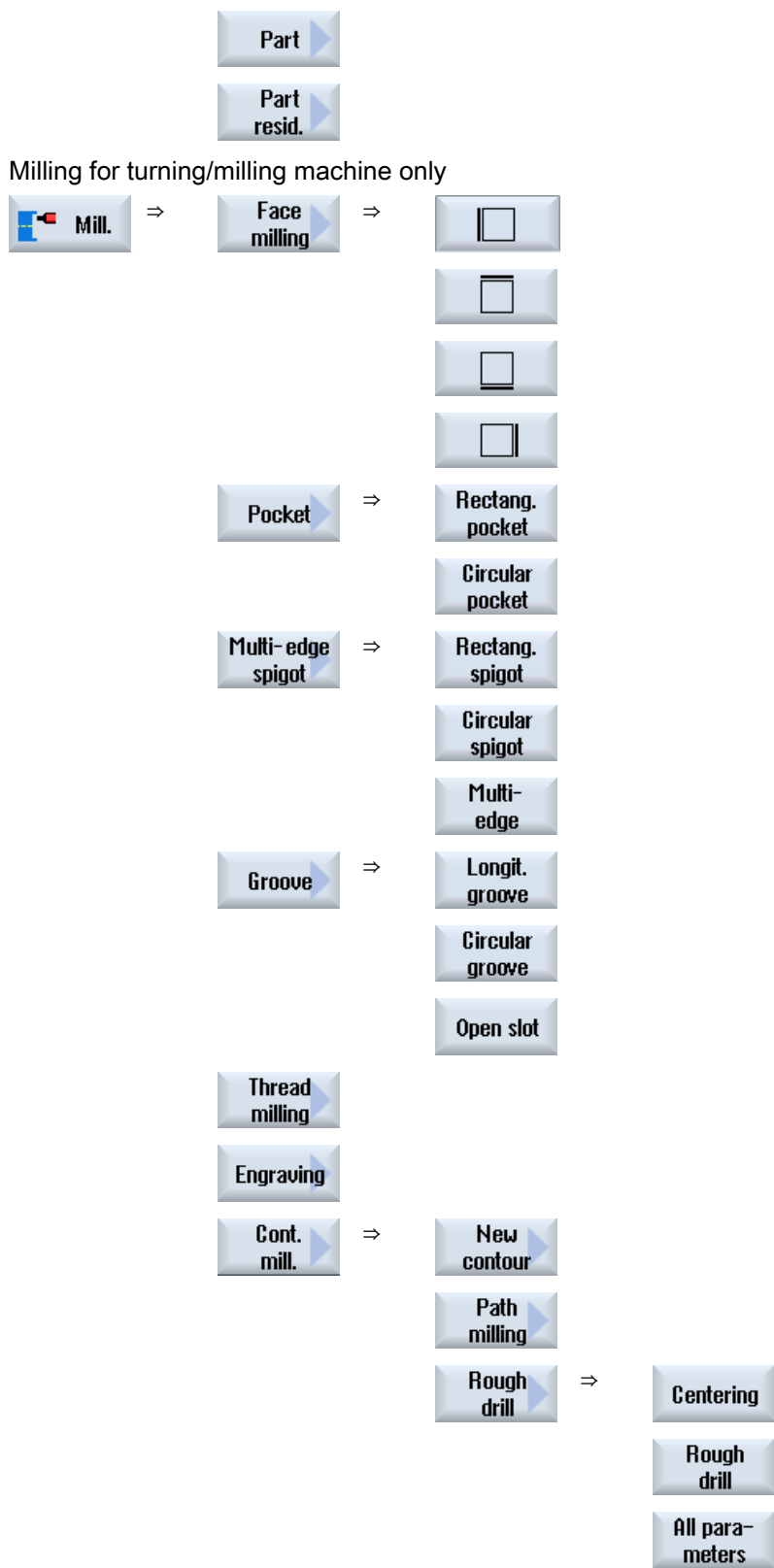

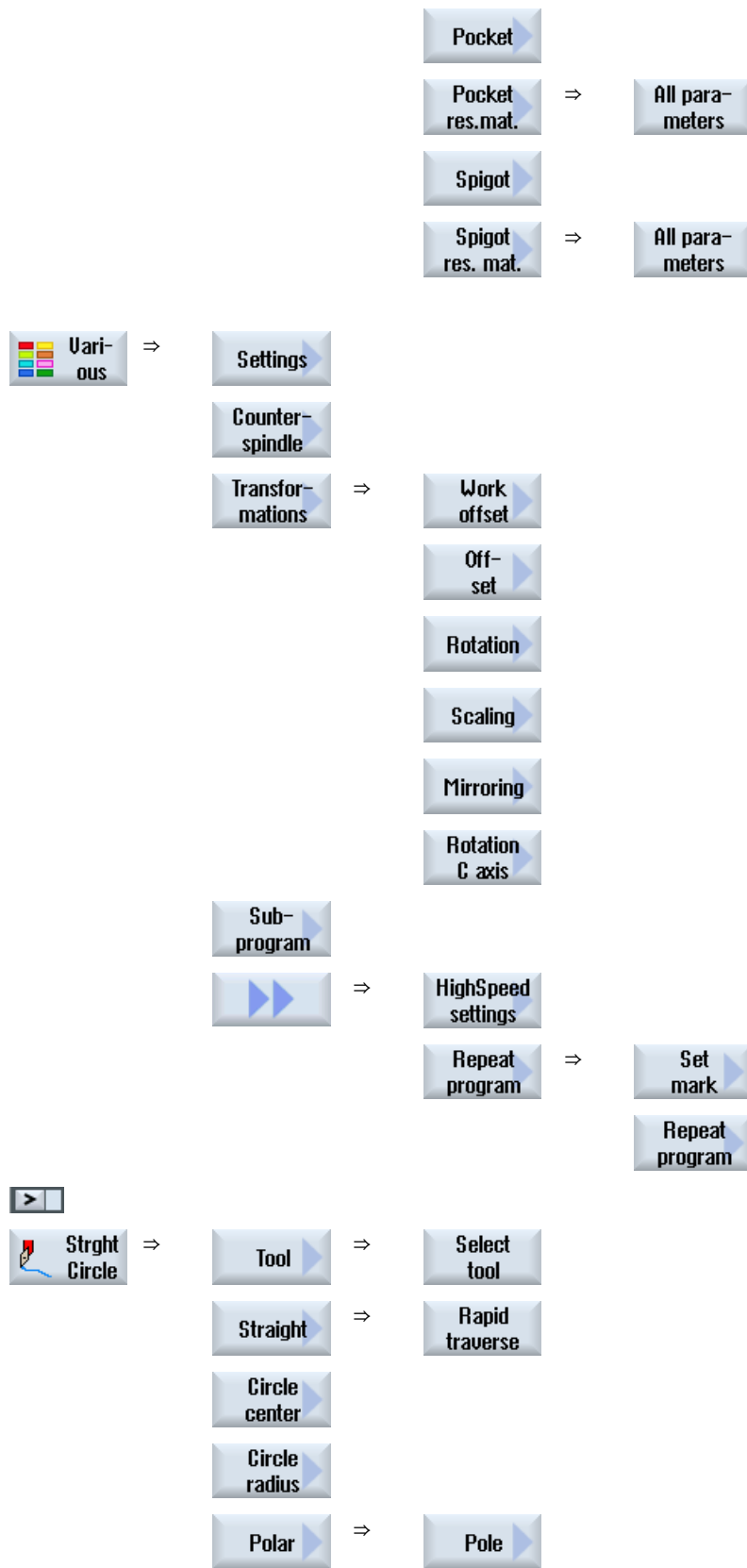

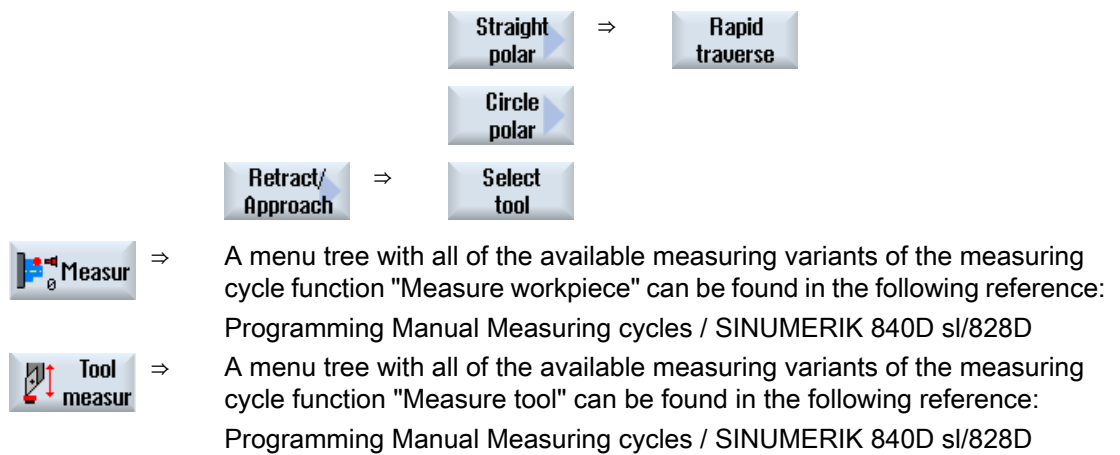

9.15 Calling technology functions

9.15.1 Additional functions in the input screens

Selection of units

- If, for example, the unit can be switched in a field, this is highlighted as soon as the cursor is positioned on the element. In this way, the operator recognizes the dependency. The selection symbol is also displayed in the tooltip.

Display of abs or inc

The abbreviations "abs" and "inc" for absolute and incremental values are displayed behind the entry fields when a switchover is possible for the field.

Help screens

2D and 3D graphics or sectional views are displayed for the parameterization of the cycles.

Online help

If you wish to obtain more detailed information about certain G code commands or cycle parameters, then you can call a context-sensitive online help.

9.15.2 Checking cycle parameters

The entered parameters are already checked during the program creation in order to avoid faulty entries.

If a parameter is assigned an illegal value, this is indicated in the input screen as follows:

- The entry field is displayed with a colored background (orange).
- The comment line displays a note.
- If the parameter entry field is selected with the cursor, the note is also displayed as a tool tip.

The programming can only be completed after the incorrect value has been corrected.

Faulty parameter values are also monitored with alarms during the cycle runtime.

9.15.3 Setting data for technological functions

Technological functions can be influenced and corrected using machine or setting data.

For additional information, please refer to the following documentation:

9.15.4 Programming variables

In principle, variables or expressions can also be used in the input fields of the screen forms instead of specific numeric values. In this way, programs can be created very flexibly.

Input of variables

Please note the following points when using variables:

- Values of variables and expressions are not checked since the values are not known at the time of programming.
- Variables and expressions cannot be used in fields in which a text is expected (e.g. tool name).
An exception is the "Engraving" function, in which you can assign the desired text in the text field via a variable as "Variable text".
- Selection fields generally cannot be programmed with variables.

Examples

```
VAR_A  
VAR_A+2*VAR_B  
SIN(VAR_C)
```

9.15.5 Changing a cycle call

You have called the desired cycle via softkey in the program editor, entered the parameters and confirmed with "Accept".

Procedure



1. Select the desired cycle call and press the <Cursor right> key.
The associated input screen of the selected cycle call is opened.

- OR -



Press the <SHIFT + INSERT> key combination.

This starts the edit mode for this cycle call and you can edit it like a normal NC block. This means that it is possible to generate an empty block before the cycle is called. For instance, to insert something before a cycle that is located at the beginning of the program.

Note: In edit mode, the cycle call can be changed in such a way that it can no longer be recompiled in the parameter screen.



You exit the edit mode by pressing the <SHIFT + INSERT> key combination.

- OR -



You are in the edit mode and press the <INPUT> key.
A new line is created after the cursor position.

9.15.6 Compatibility for cycle support

The cycle support is generally upwards compatible. This means that cycle calls in NC programs can always be recompiled with a higher software version, changed and then run again.

When transferring NC programs to a machine with a lower software version, it cannot be guaranteed, however, that the program will be able to be changed by recompiling cycle calls.

9.16 Programming the approach/retraction cycle

If you wish to shorten the approach/retraction for a machining cycle or solve a complex geometrical situation when approaching/retracting, you can generate a special cycle. In this case, the approach/retraction strategy normally used is not taken into account.

You can insert the approach/retraction cycle between any machining step program blocks, but not within linked program blocks.

Starting point

The starting point for the approach/retraction cycle is the safety clearance approached after the last machining operation.

Tool change

If you want to perform a tool change, you can move the tool through a total of 3 positions (P1 to P3) to the tool change point and through a maximum of 3 additional positions (P4 to P6) to the next starting point. If the tool does not need to be changed, however, you have a total of 6 positions available for the approach to the next starting position.

If 3 or 6 positions are not sufficient for the approach/retraction, you can call the cycle several times in succession to program further positions.

 **CAUTION**

Risk of collision

Note that the tool will move from the last position programmed in the approach/retraction cycle directly to the starting point for the next machining operation.

See also

Machining cycle, approach/retraction (Page 288)

Procedure



Press the menu forward key and the "Straight Circle" softkey.



Press the "Approach/retract" softkey.

Parameters	Description	Unit
F1 	Feedrate to approach the first position Alternatively, rapid traverse	mm/min
X1	1st position \varnothing (abs) or 1st position (inc)	mm
Z1	1st position (abs or inc)	mm

Parameters	Description	Unit
F2 U	Feedrate for approach to the second position Alternatively, rapid traverse	mm/min
X2	2nd position \emptyset (abs) or 2nd position (inc)	mm
Z2	2nd position (abs or inc)	mm
F3 U	Feedrate to approach the third position Alternatively, rapid traverse	mm/min
X3	3rd position \emptyset (abs) or 3rd position (inc)	mm
Z3	3rd position (abs or inc)	mm
Tool change U	WkzWpkt: Approach the tool change point from the last programmed position and carry out a tool change Direct: Tool is not changed at the tool change position, but at the last programmed position No: Tool is not changed	
T	Tool name - (only for "direct" tool change)	
D	Cutting edge number - (only for "direct" tool change)	
F4 U	Feedrate for approach to the fourth position Alternatively, rapid traverse	mm/min
X4	4th position \emptyset (abs) or 4th position (inc)	mm
Z4	4th position (abs or inc)	mm
F5 U	Feedrate to approach the fifth position Alternatively, rapid traverse	mm/min
X5	5st position \emptyset (abs) or 5th position (inc)	mm
Z5	5th position (abs or inc)	mm
F6 U	Feedrate to approach the sixth position Alternatively, rapid traverse	mm/min
X6	6th position \emptyset (abs) or 6th position (inc)	mm
Z6	6th position (abs or inc)	mm

9.17 Measuring cycle support

Measuring cycles are general subroutines designed to solve specific measurement tasks. They can be adapted to specific problems via parameter settings.



Software option

You require the "Measuring cycles" option to use "Measuring cycles".

References

You will find a more detailed description on how to use measuring cycles in:

Programming Manual Measuring cycles / SINUMERIK 840D sl/828D

9.18 Example: Standard machining

General information

The following example is described in detail as ShopTurn program. A G code program is generated in the same way; however, some differences must be observed.

If you copy the G code program listed below, read it into the control and open it in the editor, then you can track the individual program steps.



Machine manufacturer

Under all circumstances, observe the machine manufacturer's instructions.

Tools

The following tools are saved in the tool manager:

Roughing tool_80	80°, R0.6
Roughing tool_55	55°, R0.4
Finishing tool	35°, R0.4
Plunge cutter	Plate width 4
Threading tool_2	
Drill_D5	Ø5
Miller_D8	Ø8

Adapt the cutting data to the tools used and the specific application conditions at the machine.

Blank

Dimensions: Ø90 x 120

Material: Aluminum

Tool change point	Machine
XT	160abs
ZT	409abs
SC	1
S1	4000rev/min
Machining direction	Climbing



2. Press the "Accept" softkey.
 The work plan is displayed. Program header and end of program are created as program blocks.
 The end of program is automatically defined.

2. Stock removal cycle for facing



1. Press the "Turning" and "Stock removal" softkeys.

2. Select the machining strategy.
3. Enter the following technology parameters:
T Roughing **D1** **F** 0.300 mm/rev **V** 350 m/min
 tool_80
4. Enter the following parameters:

Machining	Roughing (▽)
Position	
Direction	Face (parallel to the X axis)
X0	90abs
Z0	2abs
X1	-1.6abs
Z1	0abs
D	2inc
UX	0inc
UZ	0.1inc



5. Press the "Accept" softkey.

3. Input of blank contour with contour computer



1. Press the "Cont. turn." and "New contour" softkeys.
The "New Contour" input window opens.



2. Enter the contour name (in this case: Cont_1).
The contour calculated as NC code is written as internal subprogram between a start and an end marker containing the entered name.



3. Press the "Accept" softkey.
The "Starting point" entry field opens.

4. Enter the starting point of the contour.

X 60abs Z 0abs



5. Press the "Accept" softkey.



6. Enter the following contour elements and acknowledge using the "Accept" softkey.



- 6.1 Z -40abs



- 6.2 X 80abs Z -45abs

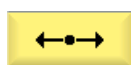

- 6.3 Z -65abs



- 6.4 X 90abs Z -70abs



- 6.5 Z -95abs



- 6.6 X 0abs

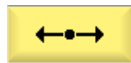

- 6.7 Z 0abs



- 6.8 X 60abs Z 0abs



- Press the "Accept" softkey.
 It is only necessary to enter the blank contour when using a pre-machined blank.

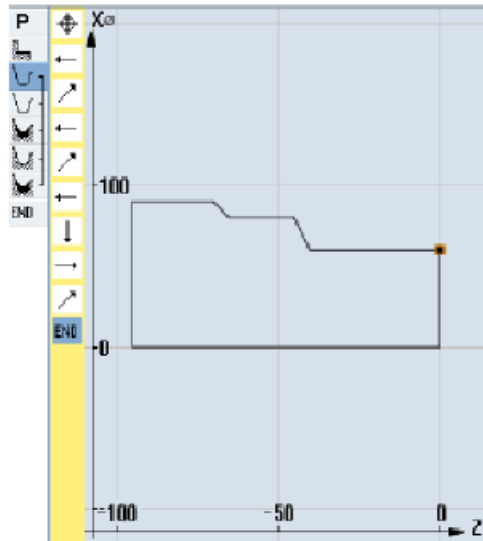

Blank contour

4. Input of finished part with contour computer



- Press the "Cont. turn." and "New contour" softkeys.
 The "New Contour" input window opens.



- Enter the contour name (in this case: Cont_2).
 The contour calculated as NC code is written as internal subprogram between a start and an end marker containing the entered name.



- Press the "Accept" softkey.
 The "Starting point" entry field opens.

- Specify the contour starting point of the contour.
 X 0abs Z 0abs



- Press the "Accept" softkey.



- Enter the following contour elements and acknowledge using the "Accept" softkey.



- 1 X 48abs FS 3

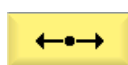

- 2 $\alpha 2$ 90°



- 3 **Direction of rotation** ?

R 23abs X 60abs K -35abs I 80 abs
 Afterwards, entry fields are inactive.



6.4 Using the "Dialog selection" softkey, select a required contour element and confirm using the "Dialog accept" softkey. The entry fields are active again. Enter the additional parameters.



FS 2



6.5 Z -80abs R 6



6.6 X 90abs Z -85abs FS3



6.7 Z -95abs



7. Press the "Accept" softkey.

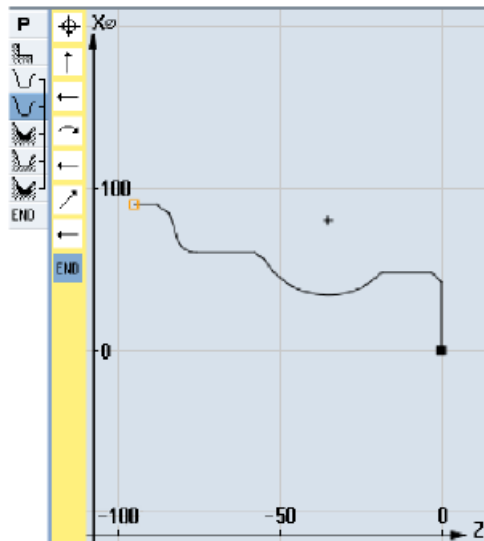

Finished-part contour

5. Stock removal (roughing)



1. Press the "Cont. turn." and "Stock removal" softkeys. The "Stock Removal" input window opens.



2. Enter the following technology parameters:
 T Roughing tool 80 D1 F 0.350 mm/rev V 400 m/min

3. Enter the following parameters:
Machining Roughing (▽)
Machining direction Longitudinal

Position outside
 Machining direction ←
 (from the face to the rear side)
 D 4.000inc
 Cutting depth ⇄
 UX 0.4inc
 UZ 0.2inc
 DI 0
 BL Cylinder
 XD 0inc
 ZD 0inc
 Relief cuts No
 Set machining area limits No



4. Press the "Accept" softkey.

If a blank programmed under "CONT_1" is used, under parameter "BL", the "Contour" blank description should be selected instead of "Cylinder". When selecting "Cylinder", the workpiece is cut from the solid material.

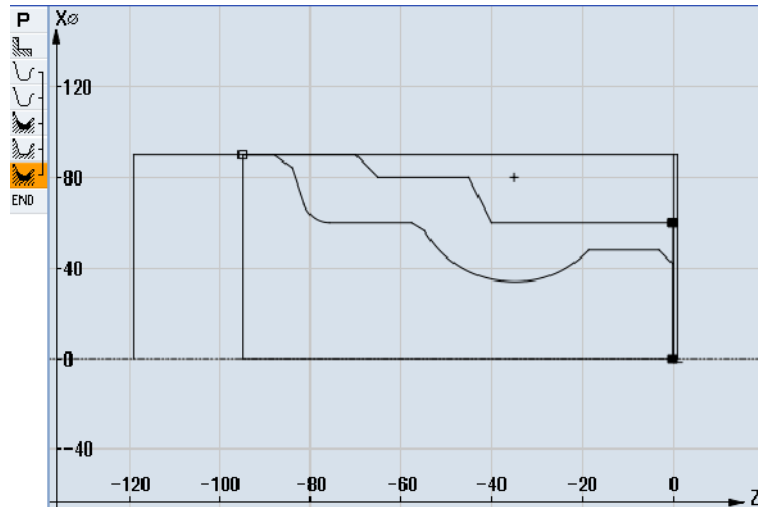

Stock removal contour

6. Solid machine residual material





1. Press the "Cont. turn." and "St. remov. resid." softkeys. The "Stock removal residual material" input window opens.



2. Enter the following technology parameters:

- T Roughing tool_55 D1 F 0.35 mm/rev V 400 m/min
- Enter the following parameters:

Machining	Roughing (▽)
Machining direction	Longitudinal
Position	outside
Machining direction	
D	2inc
Cutting depth	
UX	0.4inc
UZ	0.2inc
DI	0
Relief cuts	Yes
FR	0.200mm/rev
Set machining area limits	No
 - Press the "Accept" softkey.



7. Stock removal (finishing)



- Press the "Cont. turn." and "Stock removal" softkeys. The "Stock Removal" input window opens.
- Enter the following technology parameters:

T	Finishing tool_D1	F 0.1 mm/rev	V 450 m/min
---	-------------------	--------------	-------------
- Enter the following parameters:

Machining	Finishing (▽▽▽)
Machining direction	Longitudinal
Position	outside
Machining direction	
	(from the face to the rear side)
Allowance	No
Relief cuts	Yes
Set machining area limits	No
- Press the "Accept" softkey.





8. Groove (roughing)



1. Press the "Turning", "Groove" and "Groove with inclines" softkeys. The "Groove 1" entry field opens.

2. Enter the following technology parameters:
T Grooving **D1** **F 0.150 mm/rev** **V 220 m/min**
 tool

3. Enter the following parameters:

Machining	Roughing (∇)
Groove position	
Reference point	
X0	60abs
Z0	-70
B2	8inc
T1	4inc
α1	15degrees
α2	15degrees
FS1	1
R2	1
R3	1
FS4	1
D	2inc
UX	0.4inc
UZ	0.2inc
N	1

R2 1
 R3 1
 FS4 1
 N 1



4. Press the "Accept" softkey.

10. Longitudinal threads M48 x2 (roughing)



1. Press the "Turning", "Thread" and "Thread longitudinal" softkeys. The "Longitudinal thread" entry field opens.



2. Enter the following parameters:

T	Threading tool_2	D1
Table	without	
P	2mm/rev	
G	0	
S	995rev/min	
Machining type	Roughing (∇)	
Infeed: Constant cutting cross-section	Diminishing	
Thread	External thread	
X0	48abs	
Z0	0abs	
Z1	-25abs	
LW	4inc	
LR	4inc	
H1	1.227inc	
αP	30degrees	
Infeed		
ND	5	
U	0.150inc	
VR	1inc	
Multiple threads	No	
α0	0degrees	



3. Press the "Accept" softkey.

11. Longitudinal threads M48 x 2 (finishing)



1. Press the "Turning", "Thread" and "Thread longitudinal" softkeys. The "Longitudinal thread" entry field opens.



2. Enter the following parameters:

T	Threading tool_2	D1
Table	without	
P	2mm/rev	
G	0	
S	995rev/min	
Machining type	Finishing (VVV)	
Thread	External thread	
X0	48abs	
Z0	0abs	
Z1	-25abs	
LW	4inc	
LR	4inc	
H1	1.227inc	
αP	30degrees	
Infeed		
NN	2	
VR	1inc	
Multiple threads	No	
α0	0degrees	



3. Press the "Accept" softkey.

12. Drilling



1. Press the "Drilling", "Drilling reaming" and "Drilling" softkeys. The "Drilling" input window opens.



2. Enter the following technology parameters:

T Drill_D5	D1	F 0.1 mm/rev	V 50 m/min
-------------------	-----------	---------------------	-------------------
3. Enter the following parameters:

Machined surface	Face C
Drilling depth	Tip
Z1	10inc
DT	0s



4. Press the "Accept" softkey.

13. Positioning



1. Press the "Drilling", "Positions" and "Freely Programmable Positions" softkeys.



The "Positions" input window opens.



2. Enter the following parameters:

Machined surface	Face C
Coordinate system	Polar
Z0	0abs
C0	0abs
L0	16abs
C1	90abs
L1	16abs
C2	180abs
L2	16abs
C3	270abs
L3	16abs



3. Press the "Accept" softkey.

14. Milling the rectangular pocket



1. Press the "Milling", "Pocket" and "Rectangular pocket" softkeys. The "Rectangular Pocket" input window opens.



2. Enter the following technology parameters:

T Miller_D8	D1	F 0.030 mm/tooth	V 200 m/min
--------------------	-----------	-------------------------	--------------------

3. Enter the following parameters:

Machined surface	Face C
-------------------------	--------

Machining type	Roughing (∇)
Machining position	Single position
X0	0abs
Y0	0abs
Z0	0abs
W	23
L	23
R	8
α0	4Degrees
Z1	5inc
DXY	50%
DZ	3
UXY	0.1mm
UZ	0
Insertion	Vertical
FZ	0.015mm/tooth



4. Press the "Accept" softkey.

9.18.3 Results/simulation test

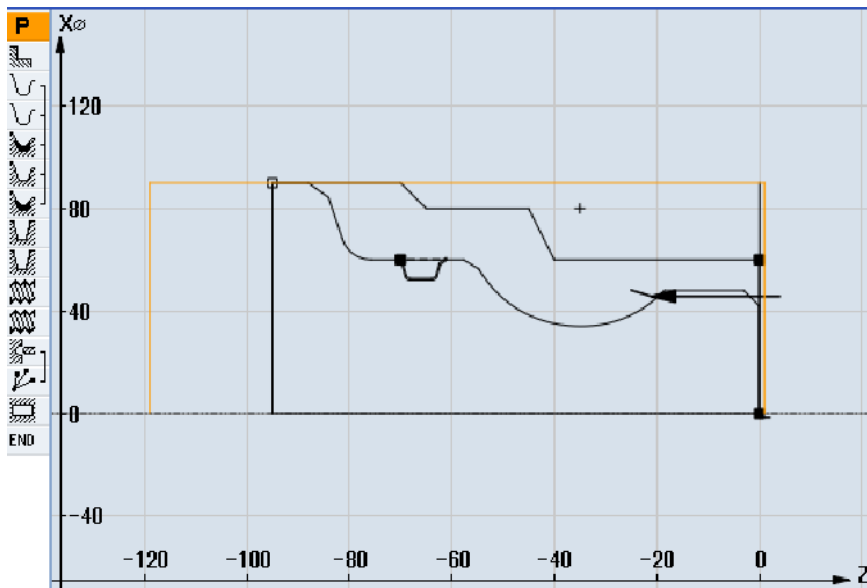

Figure 9-10 Programming graphics

P Program header		Work offset G54
	Stock removal ▾	T=Schrupper_80 F0.3/rev V=350m Face X0=90
	Contour	KONT_1
	Contour	KONT_2
	Stock removal ▾	T=Schrupper 80 F0.35/rev V=400m
	Residual cutting ▾	T=Schrupper_55 F0.35/rev V=400m
	Stock removal ▾ ▾ ▾	T=Schlichter F0.1/rev V=450m
	Groove ▾	T=Stecher F0.15/rev V=220m X0=60 Z0=-70
	Groove ▾ ▾ ▾	T=Stecher F0.1/rev V=220m X0=60 Z0=-70
	Thread long. ▾	T=Gewindestahl_2 P2mm/rev S=995rev Outside
	Thread long. ▾ ▾ ▾	T=Gewindestahl_2 P2mm/rev S=995rev Outside
	Drilling	⊕ T=Bohrer_D5 F0.1/min V=50m Z1=10inc
	001: Positions	⊕ Z0=0 C0=0 L0=16 C1=90 L1=16 C2=180 L2=16
	Rectang.pocket ▾	⊕ T=Fräser_D8 F0.03/min V=200m X0=0 Y0=0
	END End of program	

Figure 9-11 Process plan

Program test by means of simulation

During simulation, the current program is calculated in its entirety and the result displayed in graphic form.

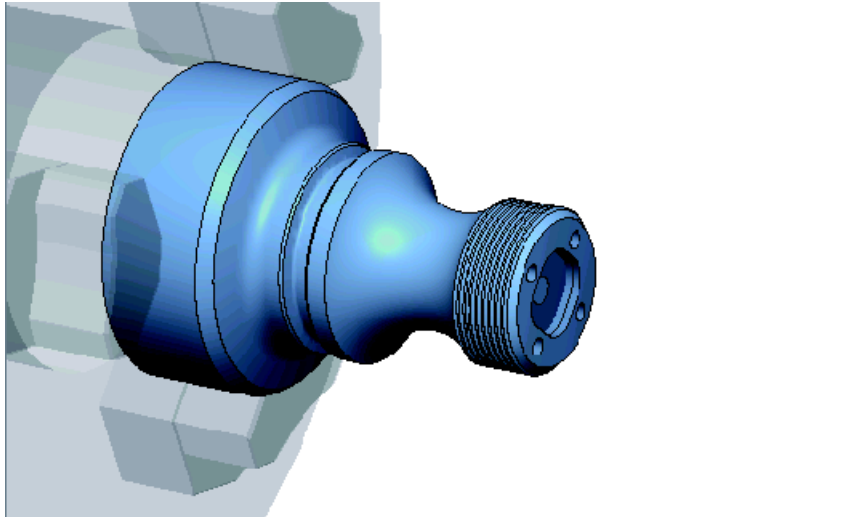

Figure 9-12 3D view

9.18.4 G code machining program

```

N1 G54
N2 WORKPIECE(,,"","CYLINDER",192,2,-120,-100,90)
N3 G0 X200 Z200 Y0
,*****
N4 T="ROUGHING TOOL_80" D1
N5 M06
N6 G96 S350 M04
N7 CYCLE951(90,2,-1.6,0,-1.6,0,1,2,0,0.1,12,0,0,0,1,0.3,0,2,1110000)
N8 G96 S400
N9 CYCLE62(,2,"E_LAB_A_CONT_2","E_LAB_E_CONT_2")
N10 CYCLE952("STOCK REMOVAL_1","BLANK_1",
2301311,0.35,0.15,0,4,0.1,0.1,0.4,0.2,0.1,0,1,0,0,,,,,2,2,,,0,1,,0,12,1110110)
N11 G0 X200 Z200
,*****
N12 T="ROUGHING TOOL_55" D1
N13 M06
N14 G96 S400 M04
N15 CYCLE952("STOCK REMOVAL_2","BLANK_1","Blank_1",
1301311,0.35,0.2,0,2,0.1,0.1,0.4,0.2,0.1,0,1,0,0,,,,,2,2,,,0,1,,0,112,1100110)
N16 G0 X200 Z200
,*****
N17 T="FINISHING TOOL" D1
N18 M06
N19 G96 S450 M04
N20 CYCLE952("STOCK REMOVAL_3",,"",
1301321,0.1,0.5,0,1.9,0.1,0.1,0.2,0.1,0.1,0,1,0,0,,,,,2,2,,,0,1,,0,12,1000110)
N21 G0 X200 Z200
,*****
N22 T="GROOVING TOOL" D1
N23 M06
N24 G96 S220 M04
N25 CYCLE930(60,-70,5.856406,8,4,,0,15,15,1,1,1,1,0.2,2,1,10110,,1,30,0.15,1,0.4,0.2,2,1001010)
N26 CYCLE930(60,-70,5.856406,8,4,,0,15,15,1,1,1,1,0.2,2,1,10120,,1,30,0.1,1,0.1,0.1,2,1001110)
N27 G0 X200 Z200
,*****
N28 T="THREADING TOOL_2" D1
N29 M06
N30 G97 S995 M03
N31 CYCLE99(0,48,-25,,4,4,1.226,0.1,30,0,5,0,2,1100103,4,1,0.2815,0.5,0,0,1,0,0.707831,1,,,,,2,0)
N32 CYCLE99(0,48,-25,,4,4,1.226,0.02,30,0,3,2,2,1210103,4,1,0.5,0.5,0,0,1,0,0.707831,1,,,,,2,0)
N33 G0 X200 Z200
,*****

```



```
N34 T="DRILL_D5" D1
N35 M06
N36 SPOS=0
N37 SETMS(2)
N38 M24 ; couple-in driven tool, machine-specific
N39 G97 S3183 M3
N40 G94 F318
N41 TRANSMIT
N42 MCALL CYCLE82(1,0,1,,10,0,0,1,11)
N43 HOLES2(0,0,16,0,30,4,1010,0,,1)
N44 MCALL
N45 M25 ; couple out driven tool, machine-specific
N46 SETMS(1)
N47 TRAFOOF
N48 G0 X200 Z200
;*****
N49 T="MILLER_D8"
N50 M6
N51 SPOS=0
N52 SETMS(2)
N53 M24
N54 G97 S1989 M03
N55 G95 FZ=0.15
N56 TRANSMIT
N57 POCKET3(20,0,1,5,23,23,8,0,0,4,3,0,0,0.12,0.08,0,11,50,8,3,15,0,2,0,1,2,11100,11,111)
N58 M25
N59 TRAFOOF
N60 DIAMON
N61 SETMS(1)
N62 G0 X200 Z200
N63 M30
;*****
N64 E_LAB_A_CONT_1: ;#SM Z:3
;#7 __DlGk contour definition begin - Don't change!;*GP*;*RO*;*HD*
G18 G90 DIAMOF;*GP*
G0 Z0 X30 ;*GP*
G1 Z-40 ;*GP*
Z-45 X40 ;*GP*
Z-65 ;*GP*
Z-70 X45 ;*GP*
Z-95 ;*GP*
X0 ;*GP*
Z0 ;*GP*
X30 ;*GP*
```

9.18 Example: Standard machining

```

;CON,2,0.0000,1,1,MST:0,0,AX:Z,X,K,I;*GP*;*RO*;*HD*
;S,EX:0,EY:30;*GP*;*RO*;*HD*
;LL,EX:-40;*GP*;*RO*;*HD*
;LA,EX:-45,EY:40;*GP*;*RO*;*HD*
;LL,EX:-65;*GP*;*RO*;*HD*
;LA,EX:-70,EY:45;*GP*;*RO*;*HD*
;LL,EX:-95;*GP*;*RO*;*HD*
;LD,EY:0;*GP*;*RO*;*HD*
;LR,EX:0;*GP*;*RO*;*HD*
;LA,EX:0,EY:30;*GP*;*RO*;*HD*
;#End contour definition end - Don't change!;*GP*;*RO*;*HD*
E_LAB_E_CONT_1:
N65 E_LAB_A_CONT_2: ;#SM Z:4
;#7__DlgK contour definition begin - Don't change!;*GP*;*RO*;*HD*
G18 G90 DIAMOF;*GP*
G0 Z0 X0 ;*GP*
G1 X24 CHR=3 ;*GP*
Z-18.477 ;*GP*
G2 Z-55.712 X30 K=AC(-35) I=AC(40) ;*GP*
G1 Z-80 RND=6 ;*GP*
Z-85 X45 CHR=3 ;*GP*
Z-95 ;*GP*
;CON,V64,2,0.0000,0,0,MST:0,0,AX:Z,X,K,I;*GP*;*RO*;*HD*
;S,EX:0,EY:0,ASE:90;*GP*;*RO*;*HD*
;LU,EY:24;*GP*;*RO*;*HD*
;F,LFASE:3;*GP*;*RO*;*HD*
;LL,DIA:225/0,AT:90;*GP*;*RO*;*HD*
;ACW,DIA:210/0,EY:30,CX:-35,CY:40,RAD:23;*GP*;*RO*;*HD*
;LL,EX:-80;*GP*;*RO*;*HD*
;R,RROUND:6;*GP*;*RO*;*HD*
;LA,EX:-85,EY:45;*GP*;*RO*;*HD*
;F,LFASE:3;*GP*;*RO*;*HD*
;LL,EX:-95;*GP*;*RO*;*HD*
;#End contour definition end - Don't change!;*GP*;*RO*;*HD*
E_LAB_E_CONT_2:

```

Programming technology functions (cycles)

10.1 Drilling

10.1.1 General

General geometry parameters

- Retraction plane RP and reference point Z0
Normally, reference point Z0 and retraction plane RP have different values. The cycle assumes that the retraction plane is in front of the reference point.

Note

If the values for reference point and retraction planes are identical, a relative depth specification is not permitted. Error message "Reference plane defined incorrectly" is output and the cycle is not executed.

This error message is also output if the retraction plane is located after the reference point, i.e. its distance to the final drilling depth is smaller.

- Safety clearance SC
Acts in relation to the reference point. The direction in which the safety clearance is active is automatically determined by the cycle.
- Drilling depth
Depending on the selection of the drill shank or drill tip or the centering diameter, the programmed drilling depth refers to the following for cycles with a selection field:
 - Tip (drilling depth in relation to the tip)
The drill is inserted into the workpiece until the drill tip reaches the value programmed for Z1.
 - Shank (drilling depth in relation to the shank)
The drill is inserted into the workpiece until the drill shank reaches the value programmed for Z1. The angle entered in the tool list is taken into account.
 - Diameter (centering in relation to the diameter, only for CYCLE81)
The diameter of the centering hole is programmed at Z1. In this case, the tip angle of the tool must be specified in the tool list. The drill is inserted into the workpiece until the specified diameter is reached.

Drilling positions

The cycle assumes the tested hole coordinates of the plane.

10.1 Drilling

The hole centers should therefore be programmed before or after the cycle call as follows (see also Section, Cycles on single position or position pattern (MCALL)):

- A single position should be programmed before the cycle call
- Position patterns (MCALL) should be programmed after the cycle call
 - as drilling pattern cycle (line, circle, etc.) or
 - as a sequence of positioning blocks for the hole centers

See also

Selection of the cycles via softkey (Page 269)

10.1.2 Centering (CYCLE81)

Function

With the "Centering" function, the tool drills with the programmed spindle speed and feedrate either:

- Down to the programmed final drilling depth or
- So deep until the programmed diameter of the centering is reached

The tool is retracted after a programmed dwell time has elapsed.

Clamping the spindle

For ShopTurn, "Clamp spindle" function can be set up by the machine manufacturer.



Machine manufacturer

Please refer to the machine manufacturer's specifications.

See also

Clamping the spindle (Page 293)

Approach/retraction

1. The tool moves with G0 to safety clearance of the reference point.
2. Inserted into the workpiece with G1 and the programmed feedrate F until the depth or the centering diameter is reached.
3. On expiry of a dwell time DT, the tool is retracted at rapid traverse G0 to the retraction plane.

Procedure





1. The part program or ShopTurn program to be processed has been created and you are in the editor.
2. Press the "Drilling" softkey.
3. Press the "Centering" softkey.
The "Centering" input window opens.

Parameters, G code program			Parameters, ShopTurn program		
PL	Machining plane		T	Tool name	
RP	Retraction plane	mm	D	Cutting edge number	
SC	Safety clearance	mm	F	Feedrate	mm/min mm/rev
			S / V	Spindle speed or constant cutting rate	rpm m/min

Parameter	Description	Unit
Machining position (only for G code)	<ul style="list-style-type: none"> • Single position Drill hole at programmed position • Position pattern Position with MCALL 	
Z0 (only for G code)	Reference point Z	mm
Machining surface (only for Shop-Turn)	<ul style="list-style-type: none"> • Face C • Face Y • Peripheral surface C • Peripheral surface Y 	
Position (only for Shop-Turn)	<ul style="list-style-type: none"> • At the front (face) • At the rear (face) • Outside (peripheral surface) • Inside (peripheral surface) 	
(only for Shop-Turn)	Clamp/release spindle The function must be set up by the machine manufacturer.	
Centering	<ul style="list-style-type: none"> • Diameter (centered with reference to the diameter) The angle for the center drill entered in the tool list is applied. • Tip (centered with reference to the depth) The drill is inserted into the workpiece until the programmed insertion depth is reached. 	
∅	It is inserted into the workpiece until the diameter is correct. - (for diameter centering only)	mm

10.1 Drilling

Parameter	Description	Unit
Z1 	Drilling depth (abs) or drilling depth in relation to Z0 (inc) It is inserted into the workpiece until it reaches Z1. - (for tip centering only)	mm
DT 	<ul style="list-style-type: none"> • Dwell time (at final drilling depth) in seconds • Dwell time (at final drilling depth) in revolutions 	s rev

10.1.3 Drilling (CYCLE82)

Function

With the "Drilling" function, the tool drills with the programmed spindle speed and feedrate down to the specified final drilling depth (shank or tip).

The tool is retracted after a programmed dwell time has elapsed.

Clamping the spindle

For ShopTurn, the "Clamp spindle" function can be set up by the machine manufacturer.



Machine manufacturer

Please refer to the machine manufacturer's specifications.

Input simple

For simple machining operations, you have the option to reduce the wide variety of parameters to the most important parameters using the "Input" selection field. In this "Input simple" mode, the hidden parameters are allocated a fixed value that cannot be adjusted.



Machine manufacturer

Various defined values can be pre-assigned using setting data.

Please refer to the machine manufacturer's specifications.

If the workpiece programming requires it, you can display and change all of the parameters using "Input complete".

See also

Clamping the spindle (Page 293)

Approach/retraction

1. The tool moves with G0 to safety clearance of the reference point.
2. The tool is inserted into the workpiece with G1 and the programmed feedrate F until it reaches the programmed final depth Z1.
3. When a dwell time DT expires, the tool is retracted at rapid traverse G0 to the retraction plane.

Procedure













1. The part program or ShopTurn program to be processed has been created and you are in the editor.
2. Press the "Drilling" softkey.
3. Press the "Drilling Reaming" softkey.
4. Press the "Drilling" softkey.
The "Drilling" input window opens.



Parameters in the "Input complete" mode

G code program parameters			ShopTurn program parameters		
Input		• Complete			
PL	Machining plane		T	Tool name	
RP	Retraction plane	mm	D	Cutting edge number	
SC	Safety clearance	mm	F	Feedrate	mm/min mm/rev
			S / V	Spindle speed or constant cutting rate	rpm m/min



Parameter	Description	Unit
Machining position (only for G code)	<ul style="list-style-type: none"> • Single position Drill hole at programmed position • Position pattern Position with MCALL 	
Z0 (only for G code)	Reference point Z	mm
Machining surface (only for Shop-Turn)	<ul style="list-style-type: none"> • Face C • Face Y • Peripheral surface C • Peripheral surface Y 	





10.1 Drilling

Parameter	Description	Unit
Position  (only for Shop-Turn)	<ul style="list-style-type: none"> At the front (face) At the rear (face) Outside (peripheral surface) Inside (peripheral surface) 	
  (only for Shop-Turn)	Clamp/release spindle The function must be set up by the machine manufacturer.	
Drilling depth 	<ul style="list-style-type: none"> Shank (drilling depth in relation to the shank) The drill is inserted into the workpiece until the drill shank reaches the value programmed for Z1. The angle entered in the tool list is taken into account. Tip (drilling depth in relation to the tip) The drill is inserted into the workpiece until the drill tip reaches the value programmed for Z1. <p>Note: If it is not possible to define an angle for the drill in the tool management, it will not be possible to select tip or shank (always tip, 0 field)</p>	
Z1 	Drilling depth (abs) or drilling depth in relation to Z0 (inc) It is inserted into the workpiece until it reaches Z1.	mm
Predrilling 	<ul style="list-style-type: none"> Yes No 	
ZA - (only for pre-drilling "yes") 	Predrilling depth (abs) or predrilling depth in relation to the reference point (inc)	mm
FA - (only for pre-drilling "yes") 	Reduced predrilling feedrate as a percentage of the drilling feedrate	%
	Predrilling feedrate (ShopMill)	mm/min or mm/rev
	Predrilling feedrate (G code)	Distance/min or distance/rev
Through drilling 	<ul style="list-style-type: none"> Yes Through drilling with feedrate FD No 	
ZD - (only for through drilling "yes") 	Depth for feedrate reduction (abs) or depth for feedrate reduction in relation to Z1 (inc)	mm



Parameter	Description	Unit
FD - (only for through drilling "yes") 	Reduced feedrate for through drilling referred to drilling feedrate F	%
	Feedrate for through drilling (ShopTurn)	mm/min or mm/rev
	Feedrate for through drilling (G code)	Distance/min or distance/rev
DT - (only for through drilling "no") 	<ul style="list-style-type: none"> Dwell time (at final drilling depth) in seconds Dwell time (at final drilling depth) in revolutions 	s rev

Parameters in the "Input simple" mode

G code program parameters			ShopTurn program parameters		
Input 	<ul style="list-style-type: none"> Simple 				
RP	Retraction plane	mm	T	Tool name	
			D	Cutting edge number	
			F 	Feedrate	mm/min mm/rev
			S / V 	Spindle speed or constant cutting rate	rpm m/min

Parameter	Description	
Machining position (only for G code) 	<ul style="list-style-type: none"> Single position Drill hole at programmed position. Position pattern Position with MCALL 	
Machining surface  (only for ShopTurn)	<ul style="list-style-type: none"> Face C Face Y Peripheral surface C Peripheral surface Y 	
Position  (only for ShopTurn)	<ul style="list-style-type: none"> At the front (face) At the rear (face) Outside (peripheral surface) Inside (peripheral surface) 	
  (only for ShopTurn)	Clamp/release spindle The function must be set up by the machine manufacturer.	

10.1 Drilling

Parameter	Description	
Drilling depth 	<ul style="list-style-type: none"> Shank (drilling depth in relation to the shank) The drill is inserted into the workpiece until the drill shank reaches the value programmed for Z1. The angle entered in the tool list is taken into account. Tip (drilling depth in relation to the tip) The drill is inserted into the workpiece until the drill tip reaches the value programmed for Z1. <p>Note: If it is not possible to define an angle for the drill in the tool management, it will not be possible to select tip or shank (always tip, 0 field).</p>	
Z0 (only for G code)	Reference point Z	mm
Z1 	Drilling depth (abs) or drilling depth in relation to Z0 (inc). It is inserted into the workpiece until it reaches Z1.	
DT 	Dwell time at final drilling depth	s rev

Hidden parameters

The following parameters are hidden. They are pre-assigned fixed values or values that can be adjusted using setting data.

Parameter	Description	Value	Can be set in SD
PL (only for G code)	Machining plane	Defined in MD 52005	
SC (only for G code)	Safety clearance	1 mm	x
Predrilling			
ZA	Predrilling depth		
FA	Reduced predrilling feedrate		
Through drilling			
ZD	Depth for reduced feedrate		
FD	Reduced through drilling feedrate		



Machine manufacturer

Please refer to the machine manufacturer's specifications.

10.1.4 Reaming (CYCLE85)

Function

With the "Reaming" cycle, the tool is inserted in the workpiece with the programmed spindle speed and the feedrate programmed at F.

If Z1 has been reached and the dwell time expired, the reamer is retracted at the programmed retraction feedrate to the retraction plane.

Clamping the spindle

For ShopTurn, the "Clamp spindle" function can be set up by the machine manufacturer.



Machine manufacturer

Please refer to the machine manufacturer's specifications.

See also

Clamping the spindle (Page 293)

Approach/retraction

1. The tool moves with G0 to safety clearance of the reference point.
2. The tool is inserted into the workpiece with the programmed feedrate F until it reaches the final depth Z1.
3. Dwell time DT at final drilling depth.
4. Retraction to retraction plane with programmed retraction feedrate FR.







Procedure



1. The part program or ShopTurn program to be processed has been created and you are in the editor.
2. Press the "Drilling" softkey.
3. Press the "Drilling Reaming" softkey.
4. Press the "Reaming" softkey.
The "Reaming" input window opens.

Parameters, G code program			Parameters, ShopTurn program		
PL	Machining plane		T	Tool name	
RP	Retraction plane	mm	D	Cutting edge number	
SC	Safety clearance	mm	F	Feedrate	mm/min mm/rev
F	Feedrate	*	S / V	Spindle speed or constant cutting rate	rpm m/min

10.1 Drilling

Parameter	Description	Unit
Machining position  (only for G code)	<ul style="list-style-type: none"> • Single position Drill hole at programmed position • Position pattern Position with MCALL 	
Z0 (only for G code)	Reference point Z	mm
FR (only for G code)	Feedrate during retraction	*
FR (only for Shop-Turn)	Feedrate during retraction	mm/min mm/rev
Machining surface  (only for Shop-Turn)	<ul style="list-style-type: none"> • Face C • Face Y • Peripheral surface C • Peripheral surface Y 	
Position  (only for Shop-Turn)	<ul style="list-style-type: none"> • At the front (face) • At the rear (face) • Outside (peripheral surface) • Inside (peripheral surface) 	
  (only for Shop-Turn)	Clamp/release spindle The function must be set up by the machine manufacturer.	
Z1	Drilling depth (abs) or drilling depth in relation to Z0 (inc) It is inserted into the workpiece until it reaches Z1.	mm
DT 	<ul style="list-style-type: none"> • Dwell time (at final drilling depth) in seconds • Dwell time (at final drilling depth) in revolutions 	s rev

* Unit of feedrate as programmed before the cycle call

10.1.5 Boring (CYCLE86)

Function

With the "Boring" cycle, the tool approaches the programmed position in rapid traverse, allowing for the retraction plane and safety clearance. It is then inserted into the workpiece at the feedrate programmed under F until it reaches the programmed depth (Z1). There is an oriented spindle stop with the SPOS command. After the dwell time has elapsed, the tool is retracted either with or without lift of the tool.

Note

If, for example, swiveling or mirroring has been performed with CYCLE800 before machining, the SPOS command must be adapted so that the spindle position acts synchronously with DX and DY.

Clamping the spindle

For ShopTurn, the "Clamp spindle" function can be set up by the machine manufacturer.



Machine manufacturer

Please refer to the machine manufacturer's specifications.

Lift

When lifting, define the amount of lift D and the tool orientation angle α .

Note

The "Boring" cycle can be used if the spindle to be used for the boring operation is technically able to go into position-controlled spindle operation.

See also

Clamping the spindle (Page 293)

Approach/retraction

1. The tool moves with G0 to safety clearance of the reference point.
2. Travel to the final drilling depth with G1 and the speed and feedrate programmed before the cycle call.
3. Dwell time at final drilling depth.
4. Oriented spindle hold at the spindle position programmed under SPOS.
5. With the "Lift" selection, the cutting edge retracts from the hole edge with G0 in up to three axes.

10.1 Drilling

6. Retraction with G0 to the safety clearance of the reference point.
7. Retraction to retraction plane with G0 to drilling position in the two axes of the plane (coordinates of the hole center point).

Procedure



1. The part program or ShopTurn program to be processed has been created and you are in the editor.
 2. Press the "Drilling" softkey.





 3. Press the softkey "Boring" for G code.







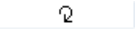

- OR -
3. Press the softkeys "Drilling Reaming" and "Boring" for ShopTurn



- The "Boring" input window opens.

Parameters, G code program			Parameters, ShopTurn program		
PL 	Machining plane		T	Tool name	
RP	Retraction plane	mm	D	Cutting edge number	
SC	Safety clearance	mm	F 	Feedrate	mm/min mm/rev
			S / V 	Spindle speed or constant cutting rate	rpm m/min

Parameter	Description	Unit
Machining position  (only for G code)	<ul style="list-style-type: none"> • Single position Drill hole at programmed position. • Position pattern Position with MCALL 	
DIR  (only for G code)	Direction of rotation <ul style="list-style-type: none"> •  •  	
Z0 (only for G code)	Reference point Z	mm

Parameter	Description	Unit
Machining surface  (only for Shop-Turn)	<ul style="list-style-type: none"> • Face C • Face Y • Peripheral surface C • Peripheral surface Y 	
Position  (only for Shop-Turn)	<ul style="list-style-type: none"> • At the front (face) • At the rear (face) • Outside (peripheral surface) • Inside (peripheral surface) 	
  (only for Shop-Turn)	Clamp/release spindle The function must be set up by the machine manufacturer.	
Z1 	Drilling depth (abs) or drilling depth in relation to Z0 (inc)	mm
DT 	<ul style="list-style-type: none"> • Dwell time at final drilling depth in seconds • Dwell time at final drilling depth in revolutions 	s rev
SPOS	Spindle stop position	Degrees
Lift mode 	<ul style="list-style-type: none"> • Do not lift off contour The cutting edge is not fully retracted, but traverses back to the safety clearance in rapid traverse. • Lift The cutting edge is retracted from the hole edge and then moved back to the retraction plane. 	
DX (only G Code)	Retraction distance in the X direction (incremental) - (for lift-off only)	mm
DY (only G code)	Retraction distance in the Y direction (incremental) - (for lift-off only)	mm
DZ (only G code)	Retraction distance in the Z direction (incremental) - (for lift-off only)	mm
D (only ShopTurn)	Retraction distance (incremental) - (for lift only)	mm

10.1.6 Deep-hole drilling 1 (CYCLE83)

Function

With the "Deep-hole drilling 1" cycle, the tool is inserted in the workpiece with the programmed spindle speed and feedrate in several infeed steps until the depth Z1 is reached. The following can be specified:

- Number of infeed steps constant or decreasing (via programmable degression factor)
- Chip breaking without lifting or swarf removal with tool retraction
- Feedrate factor the 1st infeed to reduce the feedrate or increase the feedrate (e.g. if a hole has already be predrilled)

10.1 Drilling

- Dwell times
- Depth in relation to drill shank of drill tip

Clamping the spindle

For ShopTurn, the "Clamp spindle" function can be set up by the machine manufacturer.



Machine manufacturer

Please refer to the machine manufacturer's specifications.

Input simple

For simple machining operations, you have the option to reduce the wide variety of parameters to the most important parameters using the "Input" selection field. In this "Input simple" mode, the hidden parameters are allocated a fixed value that cannot be adjusted.



Machine manufacturer

Various defined values can be pre-assigned using setting data.

Please refer to the machine manufacturer's specifications.

If the workpiece programming requires it, you can display and change all of the parameters using "Input complete".

Approach/retraction during chip breaking

1. The tool moves with G0 to safety clearance of the reference point.
2. The tool drills with the programmed spindle speed and feedrate $F = F \cdot FD1$ [%] up to the first infeed depth.
3. Dwell time at drilling depth DTB.
4. The tool is retracted by retraction distance V2 for chip breaking and drills up to the next infeed depth with programmed feedrate F.
5. Step 4 is repeated until the final drilling depth Z1 is reached.
6. Dwell time at final drilling depth DT.
7. The tool retracts to the retraction plane at rapid traverse.

Approach/retraction during stock removal

1. The tool moves with G0 to safety clearance of the reference point.
2. The tool drills with the programmed spindle speed and feedrate $F = F \cdot FD1$ [%] up to the first infeed depth.
3. Dwell time at drilling depth DTB.
4. The tool retracts from the workpiece for the stock removal with rapid traverse to the safety clearance.
5. Dwell time at starting point DTS.

6. Approach of the last drilling depth with G0, reduced by the clearance distance V3.
7. Drilling is then continued to the next drilling depth.
8. Steps 4 to 7 are repeated until the programmed final drilling depth Z1 is reached.
9. Dwell time at final drilling depth.
10. The tool retracts to the retraction plane at rapid traverse.

Procedure











1. The part program or ShopTurn program to be processed has been created and you are in the editor.
 2. Press the "Drilling" softkey.
 3. Press the "Deep-hole drilling" and "Deep-hole drilling 1" softkeys.
- The "Deep-hole drilling 1" input window opens.





Parameters in the "Input complete" mode

G code program parameters			ShopTurn program parameters		
Input		• Complete			
PL 	Machining plane		T	Tool name	
RP	Retraction plane	mm	D	Cutting edge number	
SC	Safety clearance	mm	F 	Linear feedrate Feedrate per revolution	mm/min mm/rev
			S / V 	Spindle speed or Constant cutting rate	rpm m/min



Parameter	Description	Unit
Machining position (only for G code)	<ul style="list-style-type: none"> • Single position Drill hole at programmed position • Position pattern (MCALL) Position with MCALL 	
Machining surface (only for Shop-Turn)	<ul style="list-style-type: none"> • Face C • Face Y • Peripheral surface C • Peripheral surface Y 	

10.1 Drilling









Parameter	Description	Unit
Position  (only for Shop-Turn)	<ul style="list-style-type: none"> At the front (face) At the rear (face) Outside (peripheral surface) Inside (peripheral surface) 	
  (only for Shop-Turn)	Clamp/release spindle The function must be set up by the machine manufacturer.	
Machining 	<ul style="list-style-type: none"> Swarf removal The drill is retracted from the workpiece for swarf removal. Chip breaking The drill is retracted by the retraction distance V2 for chip breaking. 	
Z0 (only for G code)	Reference point Z	mm
Drilling depth 	<ul style="list-style-type: none"> Shank (drilling depth in relation to the shank) The drill is inserted into the workpiece until the drill shank reaches the value programmed for Z1. The angle entered in the tool list is taken into account. Tip (drilling depth in relation to the tip) The drill is inserted into the workpiece until the drill tip reaches the value programmed for Z1. <p>Note: If it is not possible to define an angle for the drill in the tool management, it will not be possible to select tip or shank (always tip, 0 field).</p>	
Z1 	Final drilling depth (abs) or final drilling depth in relation to Z0 (inc) It is inserted into the workpiece until it reaches Z1.	mm
FD1	Percentage for the feedrate at the first infeed	%
D  (only for G code)	1st drilling depth (abs) or 1st drilling depth in relation to Z0 (inc)	mm
D (only for Shop-Turn)	Maximum depth infeed.	mm
DF 	<p>Infeed:</p> <ul style="list-style-type: none"> Degression amount by which each additional infeed is reduced. Percentage for each additional infeed. <p>DF = 100%: Infeed increment remains constant. DF < 100%: Infeed increment is reduced in direction of final drilling depth.</p> <p>Example: Last infeed was 4 mm; DF is 80% Next infeed = 4 x 80% = 3.2 mm Next infeed = 3.2 x 80% = 2.56 mm, etc.</p>	mm %
V1	<p>Minimum infeed - (only for DF in %)</p> <p>Parameter V1 is only available if DF<100 has been programmed.</p> <p>If the infeed increment becomes very small, a minimum infeed can be programmed in parameter "V1".</p> <p>V1 < Infeed increment: The tool is inserted by the infeed increment.</p> <p>V1 > Infeed increment: The tool is inserted by the infeed value programmed under V1.</p>	mm

Parameter	Description	Unit
V2	Retraction distance after each machining step – (for chip breaking only). Distance by which the drill is retracted for chip breaking. V2 = 0: The tool is not retracted but is left in place for one revolution.	mm
Clearance distance (for swarf removal only) 	<ul style="list-style-type: none"> Manual The clearance distance must be entered manually. Automatic The clearance distance is calculated by the cycle. 	
V3	Clearance distance – (for swarf removal only and manual limit distance) Distance to the last infeed depth that the drill approaches in rapid traverse after swarf removal.	mm
DTB (only for G code) 	<ul style="list-style-type: none"> Dwell time at drilling depth in seconds Dwell time at drilling depth in revolutions Note: DT > 0: The programmed value is effective DT = 0: The same value is effective as programmed under DTB (DT = DTB)	s rev
DT 	<ul style="list-style-type: none"> Dwell time at final drilling depth in seconds Dwell time at final drilling depth in revolutions 	s rev
DTS (only for G code) 	<ul style="list-style-type: none"> Dwell time for swarf removal in seconds Dwell time for swarf removal in revolutions 	s rev

Parameters in the "Input simple" mode

G code program parameters			ShopTurn program parameters		
Input 	<ul style="list-style-type: none"> simple 				
RP	Retraction plane	mm	T	Tool name	
			D	Cutting edge number	
			F 	Linear feedrate Feedrate per revolution	mm/min mm/rev
			S / V 	Spindle speed or Constant cutting rate	rpm m/min

10.1 Drilling

Parameter	Description	
Machining position 	<ul style="list-style-type: none"> • Single position Drill hole at programmed position. • Position pattern Position with MCALL 	
Machining 	<ul style="list-style-type: none"> • Swarf removal The drill is retracted from the workpiece for swarf removal. • Chipbreaking The drill is retracted by the retraction distance V2 for chipbreaking. 	
Z0 (only for G code)	Reference point Z	mm
Machining surface (only for ShopTurn) 	<ul style="list-style-type: none"> • Face C • Face Y • Peripheral surface C • Peripheral surface Y 	
Position (only for ShopTurn) 	<ul style="list-style-type: none"> • At the front (face) • At the rear (face) • Outside (peripheral surface) • Inside (peripheral surface) 	
 	Clamp/release spindle The function must be set up by the machine manufacturer.	
Z1 	Final drilling depth (abs) or final drilling depth in relation to Z0 (inc) It is inserted into the workpiece until it reaches Z1.	
D - (only for G code) 	1st drilling depth (abs) or 1st drilling depth in relation to Z0 (inc)	mm
D - (only for Shop-Turn)	Maximum depth infeed	mm

Hidden parameters

The following parameters are hidden. They are pre-assigned fixed values or values that can be adjusted using setting data.

Parameter	Description	Value	Can be set in SD
PL (only for G code)	Machining plane	Defined in MD 52005	
SC (only for G code)	Safety clearance	1 mm	x
Drilling depth	Drilling depth in relation to the tip	Tip	
FD1	Percentage for the feedrate for the first infeed	90 %	x
DF	Percentage for each additional infeed (for swarf removal only)	90 %	x
V1	Minimum infeed	1.2 mm	x
V2	Retraction distance after each machining step	1.4 mm	x
Clearance distance	The clearance distance is calculated by the cycle	Automatic	

Parameter	Description	Value	Can be set in SD
DBT (only for G code)	Dwell time at drilling depth	0.6 s	x
DT	Dwell time at final drilling depth	0.6 s	x
DTS (only for G code)	Dwell time for swarf removal (for swarf removal only)	0.6 s	x

**Machine manufacturer**

Please refer to the machine manufacturer's specifications.

10.1.7 Deep-hole drilling 2 (CYCLE830)

Function

The cycle "Deep-hole drilling 2" covers the complete functionality of "Deep-hole drilling 1".
in addition, the cycle provides the following functions:

- Predrilling with reduced feedrate
- Taking into account a pilot hole
- Soft first cut when entering the material
- Drilling to the final depth in one cut
- Through drilling with reduced feedrate
- Control for switching-in and switching-out the coolant

Input simple

For simple machining operations, you have the option to reduce the wide variety of parameters to the most important parameters using the "Input" selection field. In this "Input simple" mode, the hidden parameters are allocated a fixed value that cannot be adjusted.

**Machine manufacturer**

Various defined values can be pre-assigned using setting data.
Please refer to the machine manufacturer's specifications.

If the workpiece programming requires it, you can display and change all of the parameters using "Input complete".

Approach/retraction during chipbreaking

1. The tool moves with G0 to safety clearance of the reference point.
2. The tool drills with the programmed spindle speed and feedrate $F = F \cdot FD1$ [%] up to the 1st infeed depth.

10.1 Drilling

3. Dwell time at drilling depth DTB.
4. The tool is retracted by retraction distance V2 for chipbreaking and drills up to the next infeed depth with programmed feedrate F.
5. Step 4 is repeated until the final drilling depth Z1 is reached.
6. Dwell time at final drilling depth DT.
7. The tool retracts to the retraction plane at rapid traverse.

Approach/retraction during stock removal

1. The tool moves with G0 to safety clearance of the reference point.
2. The tool drills with the programmed spindle speed and feedrate $F = F \cdot FD1$ [%] up to the 1st infeed depth.
3. Dwell time at drilling depth DTB.
4. The tool retracts from the workpiece for the stock removal with rapid traverse to the safety clearance.
5. Dwell time at starting point DTS.
6. Approach of the last drilling depth with G0, reduced by the clearance distance V3.
7. Drilling is then continued to the next drilling depth.
8. Steps 4 to 7 are repeated until the programmed final drilling depth Z1 is reached.
9. The tool retracts to the retraction plane at rapid traverse.

Deep-hole drilling at the entrance to the hole

The following versions are available for deep-hole drilling 2:

- Deep-hole drilling with/without predrilling
- Deep-hole drilling with pilot hole

Note

Predrilling or pilot hole mutually exclude one another.

Predrilling

For predrilling, the reduced feedrate (FA) is used up to the predrilling depth (ZA) and then the drilling feedrate is used. For drilling with several infeed steps, the predrilling depth must be between the reference point and the 1st drilling depth.

Through drilling

For a through-hole, starting from the remaining drilling depth (ZD), a reduced feedrate (FD) is used.

Pilot hole

The cycle optionally takes into account the depth of a pilot hole. This can be programmed with `abs/inc` – or a multiple of the hole diameter (1.5 to 5*D is typical, for example) – and is assumed that it is available.

If a pilot hole exists, the 1st drilling depth must be between the pilot hole and the final drilling depth. The tool enters the pilot hole with reduced feedrate and reduced speed; these values can be programmed.

Direction of spindle rotation

The direction of spindle rotation with which the tool enters and withdraws from the pilot hole can be programmed as follows:

- with stationary spindle
- with clockwise rotating spindle
- with counterclockwise rotating spindle

This avoids long or thin drills from being broken.

Horizontal drilling

For horizontal drilling using spiral drills, entering the pilot hole is improved if the cutting edges of the drill are also in the horizontal position. To support this, the alignment of the drill in the spindle can be programmed for a specific position (SPOS).

The feedrate is stopped before reaching the pilot hole depth, the speed increased to the drilling speed and the coolant switched in.

Soft first cut into the material

The entry into the material can be influenced, depending on the tool and the material.

The soft first cut comprises two partial distances:

- The first cut feedrate is maintained to a programmable first feed distance ZS1.
- An additional programmable feed distance ZS2 immediately following ZS1 is used to continuously increase the first cut feedrate (with FLIN) to the drilling feedrate.

With chip breaking / swarf removal, this mechanism takes effect at each infeed.

The input parameters ZS1 and ZS2 are maximum values that are limited by the cycle to the infeed depth to be executed.

Deep-hole drilling at the exit from the hole

It makes sense to reduce the feedrate when for through drilling the exit is inclined with respect to the tool axis.

- Through drilling "no"
The machining feedrate is used when drilling to the final drilling depth. You then have the option of programming a dwell time at the drilling depth.
- Through drilling "yes"
Up to the remaining drilling depth, you program drilling with the drilling feedrate and, from that point onward, you program drilling with a special feedrate FD.

Retraction

Retraction can be realized at the pilot hole depth or the retraction plane.

- Retraction to the retraction plane is realized with G0 or feedrate, programmable speed as well as direction of rotation respectively stationary spindle.
- For retraction at the pilot hole depth, subsequent retraction and insertion are performed with the same data.

Note

Direction of spindle rotation

The direction of spindle rotation is not reversed; however, where necessary, can be stopped.

Coolant

The technology and tools require that also in the G code, the control for the coolant is supported.

- Coolant on
Switch on at Z0 + safety clearance or at the pilot hole depth (if a pilot hole is being used)
- Coolant off
Always switch off at the final drilling depth
- Programming in the G code
An executable block (M command or subprogram call), which can be programmed as string.

Procedure

1. The part program or ShopTurn program to be processed has been created and you are in the editor.
 2. Press the "Drilling" softkey.
 3. Press the "Deep-hole drilling" and "Deep-hole drilling 2" softkeys.
- The "Deep-hole drilling 2" input window opens.













Parameters in the "Input complete" mode







G code program parameters		ShopTurn program parameters			
Input 	• Complete				
PL	Machining plane				

G code program parameters			ShopTurn program parameters		
RP	Retraction plane	mm	T	Tool name	
SC	Safety clearance	mm	D	Cutting edge number	
F	Feedrate	Path/rev Path/min	F	Linear feedrate Feedrate per revolution	mm/min mm/rev
S / V 	Direction of spindle rotation		S / V 	Spindle speed or Constant cutting rate	rpm m/min
	Spindle speed or Constant cutting rate	rpm Distance/ min			

Parameter	Description	Unit
Machining position (only G code)	<ul style="list-style-type: none"> Single position Drill hole at programmed position Position pattern with MCALL 	
Z0 (only G code)	Reference point Z	mm
Machining surface (only ShopTurn)	<ul style="list-style-type: none"> Face Face B Peripheral 	
Position (only for ShopTurn) 	<ul style="list-style-type: none"> At the front (face) At the rear (face) Outside (peripheral surface) Inside (peripheral surface) 	
Drilling depth 	<ul style="list-style-type: none"> Shank (drilling depth in relation to the shank) The drill is inserted into the workpiece until the drill shank reaches the value programmed for Z1. The angle entered in the tool list is taken into account. Tip (drilling depth in relation to the tip) The drill is inserted into the workpiece until the drill tip reaches the value programmed for Z1. 	
Z1 	Final drilling depth (abs) or final drilling depth in relation to Z0 (inc). It is inserted into the workpiece until it reaches Z1.	mm
Coolant on - (only G code)	M function to switch on the coolant.	
Technology at the entrance to the hole	Selecting the drilling feedrate <ul style="list-style-type: none"> Without predrilling Drilling with feedrate F With predrilling Drilling with feedrate FA With pilot hole Insertion in the pilot hole with feedrate FP. 	
ZP - (only for pilot hole) 	Depth of the pilot hole as a factor of the bore diameter Depth of the pilot hole in relation to Z0 (inc) or depth of the pilot hole (abs)	* Ø mm

10.1 Drilling

Parameter	Description	Unit	
ZPV - (only for pilot hole) 	Clearance distance of pilot hole	mm	
FP - (only for pilot hole) 	First cut feedrate as a percentage of the drilling feedrate	%	
	First cut feedrate (ShopTurn)	mm/rev or mm/min	
	First cut feedrate (G code)	distance/min or distance/rev	
SP / VP (only for pilot hole)	 Approach when spindle is stationary	Degrees	
		Spindle speed when approaching as percentage of the drilling speed	%
		Spindle speed during approach	rpm
		Constant cutting rate when approaching (G code)	Path/min
Constant cutting rate when approaching (ShopTurn)		m/min	
ZA - (only for pre-drilling) 	Predrilling depth (abs) or predrilling depth in relation to Z0 (inc)	mm	
FA - (only for pre-drilling) 	Predrilling feedrate as a percentage of the drilling feedrate	%	
	Predrilling feedrate (ShopTurn)	mm/min or mm/rev.	
	Predrilling feedrate (G code)	distance/min or distance/rev	
Soft first cut 	<ul style="list-style-type: none"> • Yes First cut with feedrate FS • No First cut with drilling feedrate 		
ZS1 (only "Yes" for soft first cut)	Depth of each first cut with constant first cut feedrate FS (inc)	mm	
FS (only "Yes" for soft first cut) 	First cut feedrate as a percentage of the drilling feedrate	%	
	First cut feedrate (ShopTurn)	mm/min or mm/rev.	
	First cut feedrate (G code)	distance/min or distance/rev	
ZS2 (only "Yes" for soft first cut)	Depth of each first cut for feedrate increase (inc)	mm	
Machining 	<ul style="list-style-type: none"> • One cut • Chip breaking • Swarf removal • Chip breaking and swarf removal 		
FD1	Percentage for the feedrate at the first infeed.	%	
D 	1st drilling depth (abs) or 1st drilling depth in relation to Z0 (inc)	mm	

Parameter	Description	Unit
DF 	Infeed: <ul style="list-style-type: none"> Degression amount by which each additional infeed is reduced. Percentage for each additional infeed. DF = 100%: Infeed increment remains constant. DF < 100%: Infeed increment is reduced in direction of final drilling depth. Example: Last infeed was 4 mm; DF is 80% Next infeed = 4 x 80% = 3.2 mm Next infeed = 3.2 x 80% = 2.56 mm, etc.	mm %
V1	Minimum infeed - (only for DF in %) Parameter V1 is only available if DF<100 has been programmed. If the infeed increment becomes very small, a minimum infeed can be programmed in parameter "V1". V1 < Infeed increment: The tool is inserted by the infeed increment. V1 > Infeed increment: The tool is inserted by the infeed value programmed under V1.	mm
V2 (only for chip breaking and soft first cut "no")	Retraction distance after each machining step. Distance by which the drill is retracted for chip breaking. V2 = 0: The tool is not retracted but is left in place for one revolution.	mm
DTB 	<ul style="list-style-type: none"> Dwell time at drilling depth in seconds Dwell time at drilling depth in revolutions 	s rev
Clearance distance (only for swarf removal and soft first cut "no")	<ul style="list-style-type: none"> Manual The clearance distance must be entered manually. Automatic The clearance distance is calculated by the cycle. 	
V3 – (for "manual" clearance distance only)	Clearance distance (inc)	mm
N - (only for "chip breaking and swarf removal")	Number of chip breaking strokes before each swarf removal operation.	
Retraction for swarf removal 	<ul style="list-style-type: none"> Swarf removal at the pilot hole depth Swarf removal at the safety clearance 	
DTS 	<ul style="list-style-type: none"> Dwell time for swarf removal in seconds Dwell time for swarf removal in revolutions 	s rev
Through drilling 	<ul style="list-style-type: none"> Yes Through drilling with feedrate FD No Drilling with constant feedrate 	
ZD - (only for through drilling "yes") 	Depth for through drilling feedrate (abs) or depth for through drilling feedrate in relation to Z1 (inc)	mm











10.1 Drilling

Parameter	Description	Unit	
FD - (only for through drilling "yes")	Feedrate for through drilling referred to drilling feedrate F.	%	
	Feedrate for through drilling (ShopTurn).	mm/min or mm/rev.	
	Feedrate for through drilling (G code).	distance/min or distance/rev	
DT - (only for through drilling "no")	<ul style="list-style-type: none"> Dwell time at final depth in seconds Dwell time at final depth in revolutions 	s U	
Retraction	<ul style="list-style-type: none"> Retraction to pilot hole depth Retraction to retraction plane 		
FR	Retraction in rapid traverse		
	Retraction feedrate (G code)	Path/min	
	Retraction feedrate (ShopTurn)	mm/min	
SR / VR (only for selected spindle direction of rotation)	Retraction with stationary spindle		
	Direction of spindle rotation during retraction	Spindle speed for retraction to the drilling speed	%
		Spindle speed for retraction	rpm
		Constant cutting rate for retraction (G code)	Path/min
	Constant cutting rate for retraction (ShopTurn)	m/min	
Coolant off - (only G code)	M function to switch off the coolant		

Parameters in the "Input simple" mode

G code program parameters			ShopTurn program parameters		
Input	<ul style="list-style-type: none"> simple 				
RP	Retraction plane	mm	T	Tool name	
F	Feedrate	mm/min mm/rev	D	Cutting edge number	
S / V	Spindle speed or constant cutting rate	rpm m/min	F	Feedrate	mm/min mm/rev
			S / V	Spindle speed or constant cutting rate	rpm m/min

Parameter	Description	Unit
Machining position (only G code)	<ul style="list-style-type: none"> Single position Drill hole at programmed position Position pattern with MCALL 	
Z0 (only G code)	Reference point Z	mm

Parameter	Description	Unit
Machining surface  (only ShopTurn)	<ul style="list-style-type: none"> • Face • Face B • Peripheral 	
Z1 	Final drilling depth (abs) or final drilling depth in relation to Z0 (inc) It is inserted into the workpiece until it reaches Z1.	mm
Coolant on - (only G code)	M function to switch on the coolant	
ZP 	Depth of the pilot hole as a factor of the bore diameter Depth of the pilot hole in relation to Z0 (inc) or depth of the pilot hole (abs)	* Ø mm
ZPV 	Clearance distance of pilot hole	mm
FP 	First cut feedrate in percent of the drilling feedrate	%
	First cut feedrate (ShopTurn)	mm/rev or mm/min
	First cut feedrate (G code)	distance/min or distance/rev
SP	 Spindle position during approach (spindle off)	Degrees
Soft section 	<ul style="list-style-type: none"> • Yes First cut with feedrate FS • No First cut with drilling feedrate 	
ZS1 (only "Yes" for soft first cut)	Depth of each first cut with constant first cut feedrate FS (inc)	mm
ZS2 (only "Yes" for soft first cut)	Depth of each first cut for feedrate increase (inc)	mm
FS (only "Yes" for soft first cut) 	First cut feedrate in percent of the drilling feedrate	%
	First cut feedrate (ShopTurn)	mm/min or mm/rev
	First cut feedrate (G code)	distance/min or distance/rev
Through drilling 	<ul style="list-style-type: none"> • Yes Through drilling with feedrate FD • No 	
ZD - (only for through drilling "yes") 	Depth for through drilling feedrate (abs) or depth for through drilling feedrate in relation to Z1 (inc)	mm
FD - (only for through drilling "yes") 	Feedrate for through drilling referred to drilling feed rate F	%
	Feedrate for through drilling (ShopTurn)	mm/min or mm/rev
	Feedrate for through drilling (G code)	distance/min or distance/rev
Coolant off - (only G code)	M function to switch off the coolant	

10.1 Drilling

Hidden parameters

The following parameters are hidden. They are pre-assigned fixed values or values that can be adjusted using setting data.

Parameter	Description	Value	Can be set in SD
PL (only for G code)	Machining plane	Defined in MD 52005	
SC (only for G code)	Safety clearance	1 mm	x
Drilling depth	Drilling depth referred to the shaft or tip	Tip	
Entrance to the hole	Technology at the entrance to the hole	With pilot hole	
ZA	Predrilling depth (inc)	1mm	
FA	Predrilling feed	50 %	
Drilling interruption	<ul style="list-style-type: none"> • 1 cut • Chipbreaking • Swarf removal • Chipbreaking and swarf removal 		
D	1st drilling depth referred to Z0 (inc.)	10 mm	
FD1	Percentage for the feedrate for the first infeed		
DF	Percentage for the feedrate for each additional infeed Infeed increment is continually reduced in the direction of final drilling depth	90 %	
V1	Minimum infeed V1 < Infeed increment: The tool is inserted by the infeed increment V1 > Infeed increment: The tool is inserted by the infeed value programmed under V1.	2 mm	
V2	Retraction distance after each machining step	1 mm	
Clearance distance	The clearance distance is calculated by the cycle.	Automatic	
DTB	Dwell time at each drilling depth	0.6 s	
N - (only for "chip-breaking and swarf removal")	Number of chipbreaking strokes before each swarf removal operation	1	
Retraction for swarf removal	Swarf removal at the pilot hole depth or safety clearance	Safety clearance	
DTS	Dwell time for swarf removal in seconds	0.6 s	
DT - (only for through drilling "no")	Dwell time at final depth in seconds	0.6 s	
Retraction	Retraction to pilot hole depth or retraction plane	Pilot hole depth	
FR	Retraction in rapid traverse		

Parameter	Description	Value	Can be set in SD
Direction of spindle rotation during retraction		M5	
SR (only for selected spindle direction of rotation)	Spindle speed for retraction referred to the drilling speed	10 %	

**Machine manufacturer**

Please observe the information provided by the machine manufacturer.

10.1.8 Tapping (CYCLE84, 840)

Function

You can machine an internal thread with the "tapping" cycle.

The tool moves to the safety clearance with the active speed and rapid traverse. The spindle stops, spindle and feedrate are synchronized. The tool is then inserted in the workpiece with the programmed speed (dependent on %S).

You can choose between drilling in one cut, chipbreaking or retraction from the workpiece for swarf removal.

Depending on the selection in the "Compensating chuck mode" field, alternatively the following cycle calls are generated:

- With compensating chuck: CYCLE840
- Without compensating chuck: CYCLE84

When tapping with compensating chuck, the thread is produced in one cut. CYCLE84 enables tapping to be performed in several cuts if the spindle is equipped with a measuring system.

Clamping the spindle

For ShopTurn, the "Clamp spindle" function can be set up by the machine manufacturer.

**Machine manufacturer**

Please refer to the machine manufacturer's specifications.

Input simple (only for G code)

For simple machining operations, you have the option to reduce the wide variety of parameters to the most important parameters using the "Input" selection field. In this "Input simple" mode, the hidden parameters are allocated a fixed value that cannot be adjusted.



Machine manufacturer

Various defined values can be pre-assigned using setting data.

Please refer to the machine manufacturer's specifications.

If the workpiece programming requires it, you can display and change all of the parameters using "Input complete".

Approach/retraction - CYCLE840 - with compensating chuck

1. The tool moves with G0 to safety clearance of the reference point.
2. The tool drills with G1 and the programmed spindle speed and direction of rotation to depth Z1. The feedrate F is calculated internally in the cycle from the speed and pitch.
3. The direction of rotation is reversed.
4. Dwell time at final drilling depth.
5. Retraction to safety clearance with G1.
6. Reversal of direction of rotation or spindle stop.
7. Retraction to retraction plane with G0.

Approach/retraction CYCLE84 - without compensating chuck in the "1 cut" mode

1. Travel with G0 to the safety clearance of the reference point.
2. Spindle is synchronized and started with the programmed speed (dependent on %S).
3. Tapping with spindle-feedrate synchronization to Z1.
4. Spindle stop and dwell time at drilling depth.
5. Spindle reverse after dwell time has elapsed.
6. Retraction with active spindle retraction speed (dependent on %S) to safety clearance
7. Spindle stop.
8. Retraction to retraction plane with G0.

Approach/retraction CYCLE84 - without compensating chuck in the "swarf removal" mode

1. The tool drills at the programmed spindle speed S (dependent on %S) as far as the 1st infeed depth (maximum infeed depth D).
2. Spindle stop and dwell time DT.
3. The tool retracts from the workpiece for the stock removal with spindle speed SR to the safety clearance.
4. Spindle stop and dwell time DT.

5. The tool then drills with spindle speed S as far as the next infeed depth.
6. Steps 2 to 5 are repeated until the programmed final drilling depth Z1 is reached.
7. On expiry of dwell time DT, the tool is retracted with spindle speed SR to the safety clearance. The spindle stops and retracts to the retraction plane.

Approach/retraction CYCLE84 - without compensating chuck in the "chip breaking" mode

1. The tool drills at the programmed spindle speed S (dependent on %S) as far as the 1st infeed depth (maximum infeed depth D).
2. Spindle stop and dwell time DT.
3. The tool retracts by the retraction distance V2 for chip breaking.
4. The tool then drills to the next infeed depth at spindle speed S (dependent on %S).
5. Steps 2 to 4 are repeated until the programmed final drilling depth Z1 is reached.
6. On expiry of dwell time DT, the tool is retracted with spindle speed SR to the safety clearance. The spindle stops and retracts to the retraction plane.



Machine manufacturer



Please refer to the machine manufacturer's specifications.

Procedure











1. The part program or ShopTurn program to be processed has been created and you are in the editor.
2. Press the "Drilling" softkey.
3. Press the "Thread" and "Tapping" softkeys. The "Tapping" input window opens.

Parameters in the "Input complete" mode



G code program parameters			ShopTurn program parameters		
Input (only for G code) • Complete					
PL 	Machining plane		T	Tool name	
RP	Retraction plane	mm	D	Cutting edge number	
SC	Safety clearance	mm	S / V 	Spindle speed or constant cutting rate	rpm m/min



10.1 Drilling

Parameter	Description	Unit
Compensating chuck mode 	<ul style="list-style-type: none"> with compensating chuck without compensating chuck 	
Machining position  (only for G code)	<ul style="list-style-type: none"> Single position Drill hole at programmed position Position pattern Position with MCALL 	
Z0 (only for G code)	Reference point Z	mm
Machining - (with compensating chuck) 	<p>You can select the following technologies for tapping:</p> <ul style="list-style-type: none"> with encoder Tapping with spindle encoder without encoder Tapping without spindle encoder - the following fields are displayed: <ul style="list-style-type: none"> Select the "pitch" parameter (only G code) Enter parameter "DT" (only ShopMill) <p>Note: For ShopMill, the selection box is only displayed if tapping without encoder is enabled. Please observe the information provided by your machine manufacturer.</p>	
SR (only for Shop-Turn)	Spindle speed for retraction - (only for spindle speed "S")	rev/min
VR (only for Shop-Turn)	Constant cutting rate for retraction - (only for constant cutting rate "V")	m/min
Machining surface  (only for Shop-Turn)	<ul style="list-style-type: none"> Face C Face Y Face B Peripheral surface C Peripheral surface Y 	
Position  (only for Shop-Turn)	<ul style="list-style-type: none"> At the front (face) At the rear (face) Outside (peripheral surface) Inside (peripheral surface) 	
  (only for Shop-Turn)	Clamp/release spindle The function must be set up by the machine manufacturer.	
Z1 	End point of the thread (abs) or thread length (inc) - only for G code and ShopTurn machining surface "face" It is inserted into the workpiece until it reaches Z1.	mm
X1 	End point of the thread (abs) or thread length (inc) - (only for ShopTurn machining surface, "peripheral") It is inserted into the workpiece until X1 is reached.	mm

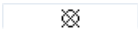
Parameter	Description	Unit
Pitch - (only machining without encoder) U (only for G code)	<ul style="list-style-type: none"> User input Pitch is obtained from the input Active feedrate Pitch is obtained from the feedrate 	
Thread (only for G code) U	Direction of rotation of the thread <ul style="list-style-type: none"> Right-hand thread Left-hand thread (only in mode "without compensating chuck")	
Table U	Thread table selection: <ul style="list-style-type: none"> without ISO metric Whitworth BSW Whitworth BSP UNC 	
Selection U	Selection of table value: e.g. <ul style="list-style-type: none"> M3; M10; etc. (ISO metric) W3/4"; etc. (Whitworth BSW) G3/4"; etc. (Whitworth BSP) 1" - 8 UNC; etc. (UNC) 	
P U - (selection only possible for table selection "without")	Pitch ... <ul style="list-style-type: none"> in MODULUS: $MODULUS = Pitch/\pi$ in turns per inch: Used with pipe threads, for example. When entered per inch, enter the integer number in front of the decimal point in the first parameter field and the figures after the decimal point as a fraction in the second and third field. in mm/rev in inch/rev The pitch is determined by the tool used.	MODULUS Turns/" mm/rev in/rev
α S (only for G code)	Starting angle offset - (only for tapping without compensating chuck)	Degrees
S (only for G code)	Spindle speed - (only for tapping without compensating chuck)	rev/min
Machining (not in the "with compensating chuck" mode) U	The following machining operations can be selected: <ul style="list-style-type: none"> 1 cut The thread is drilled in one cut without interruption. Chipbreaking The drill is retracted by the retraction amount V2 for chipbreaking. Swarf removal The drill is retracted from the workpiece for swarf removal. 	
D	Maximum depth infeed - (only when used without compensating chuck, swarf removal or chipbreaking)	mm







10.1 Drilling

Parameter	Description	Unit
Retraction U	Retraction distance - (for chipbreaking only) <ul style="list-style-type: none"> Manual Retraction distance after each machining step (V2) Automatic The tool is retracted by one revolution. 	
V2	Retraction distance after each machining step – (only without compensating chuck, chip-breaking and manual retraction) Distance by which the drill is retracted for chipbreaking.	mm
DT (for ShopTurn, only in the mode "with compensating chuck without encoder")	Dwell time in seconds: <ul style="list-style-type: none"> without compensating chuck <ul style="list-style-type: none"> 1 cut: Dwell time at final drilling depth Chip breaking: Dwell time at drilling depth Swarf removal: Dwell time at the drilling depth and after retraction with compensating chuck <ul style="list-style-type: none"> with encoder: Dwell time after drilling without encoder: Dwell time at final drilling depth 	s
SR (only for G code)	Spindle speed for retraction - (only for when a compensating chuck is not used)	rev/min
SDE U (only for G code)	Direction of rotation after end of cycle: <ul style="list-style-type: none">    	
Technology U	Adapting the technology: <ul style="list-style-type: none"> Yes <ul style="list-style-type: none"> Exact stop Precontrol Acceleration Spindle No <p>Note: The technology fields are only displayed if their display has been enabled. Please observe the information provided by your machine manufacturer.</p>	
Exact stop (only for technology, yes) U	<ul style="list-style-type: none"> Empty: Behavior the same as it was before the cycle was called G601: Block advance for exact stop fine G602: Block advance for exact stop coarse G603: Block advance if the setpoint is reached 	
Precontrol (only for technology, yes) U	<ul style="list-style-type: none"> Empty: Behavior the same as it was before the cycle was called FFWON: with precontrol FFWOF: without precontrol 	



Parameter	Description	Unit
Acceleration (only for technology, yes) 	(only in mode "without compensating chuck") <ul style="list-style-type: none"> • Empty: Behavior the same as it was before the cycle was called • SOFT: Jerk-limited (soft) acceleration of the axes • BRISK: Abrupt acceleration of the axes • DRIVE: Reduced axis acceleration 	
Spindle (only for technology, yes) 	(only in mode "without compensating chuck") <ul style="list-style-type: none"> • Speed controlled: Spindle for MCALL: Speed-controlled mode • Position controlled: Spindle for MCALL: Position-controlled operation 	

Parameters in the mode "Input simple" (only for G code program)

G code program parameters					
Input 	<ul style="list-style-type: none"> • simple 				
RP	Retraction plane	mm			

Parameter	Description	Unit
Compensating chuck mode 	<ul style="list-style-type: none"> • with compensating chuck • Without compensating chuck 	
Machining position 	<ul style="list-style-type: none"> • Single position Drill hole at programmed position. • Position pattern Position with MCALL 	
Z0	Reference point Z	mm
Z1 	End point of the thread (abs) or thread length (inc) It is inserted into the workpiece until it reaches Z1.	mm
Machining - (with compensating chuck) 	<ul style="list-style-type: none"> • With encoder Tapping with spindle encoder • without encoder Tapping without spindle encoder; selection: - Define "Pitch" parameter 	
Pitch - (only machining without encoder) 	<ul style="list-style-type: none"> • User input Pitch is obtained from the input • Active feedrate Pitch is obtained from the feedrate 	
Thread 	Direction of rotation of the thread <ul style="list-style-type: none"> • Right-hand thread • Left-hand thread (only in mode "without compensating chuck")	

10.1 Drilling

Parameter	Description	
P 	Pitch ... <ul style="list-style-type: none"> in MODULUS: $MODULUS = Pitch/\pi$ in turns per inch: Used with pipe threads, for example. When entered per inch, enter the integer number in front of the decimal point in the first parameter field and the figures after the decimal point as a fraction in the second and third field. in mm/rev in inch/rev The pitch is determined by the tool being used	MODULUS Turns/" mm/rev in/rev
S	Spindle speed - (only for tapping without compensating chuck)	
Machining  (not for "with compensating chuck")	The following machining operations can be selected: <ul style="list-style-type: none"> 1 cut The thread is drilled in one cut without interruption. Chipbreaking The drill is retracted by the retraction amount V2 for chipbreaking. Swarf removal The drill is retracted from the workpiece for swarf removal. 	
D	Maximum depth infeed - (only for tapping without compensating chuck, swarf removal or chipbreaking)	mm
SR	Spindle speed for retraction - (only for "without compensating chuck")	rev/min

Hidden parameters

The following parameters are hidden. They are pre-assigned fixed values or values that can be adjusted using setting data.

Parameter	Description	Value	Can be set in SD
PL	Machining plane	Defined in MD 52005	
SC	Safety clearance	1 mm	x
Table	Thread table selection	without	
αS	Starting angle offset	0°	
Retraction	Without retraction distance after each machining step - (for chip breaking only)	Automatic	
DT	Dwell time at final drilling depth	0.6 s	x
SDE	Direction of rotation after end of cycle		



Machine manufacturer

Please refer to the machine manufacturer's specifications.

10.1.9 Drill and thread milling (CYCLE78)

Function

You can use a drill and thread milling cutter to manufacture an internal thread with a specific depth and pitch in one operation. This means that you can use the same tool for drilling and thread milling, a change of tool is superfluous.

The thread can be machined as a right- or left-hand thread.

Clamping the spindle

For ShopTurn, the "Clamp spindle" function can be set up by the machine manufacturer.



Machine manufacturer

Please refer to the machine manufacturer's specifications.

See also

Clamping the spindle (Page 293)

Approach/retraction

1. The tool traverses with rapid traverse to the safety clearance.
2. If pre-drilling is required, the tool traverses at a reduced drilling feedrate to the predrilling depth defined in a setting data (ShopMill/ShopTurn). When programming in G code, the predrilling depth can be programmed using an input parameter.



Machine manufacturer

Please also refer to the machine manufacturer's instructions.

1. The tool bores at drilling feedrate F1 to the first drilling depth D. If the final drilling depth Z1 is not reached, the tool will travel back to the workpiece surface in rapid traverse for stock removal. Then the tool will traverse with rapid traverse to a position 1 mm above the drilling depth previously achieved - allowing it to continue drilling at drill feedrate F1 at the next infeed. Parameter "DF" is taken into account from the 2nd infeed and higher (refer to the table "Parameters").
2. If another feedrate FR is required for through-boring, the residual drilling depth ZR is drilled with this feedrate.
3. If required, the tool traverses back to the workpiece surface for stock removal before thread milling with rapid traverse.
4. The tool traverses to the starting position for thread milling.
5. The thread milling is carried out (climbing, conventional or conventional + climbing) with milling feedrate F2. The thread milling acceleration path and deceleration path is traversed in a semicircle with concurrent infeed in the tool axis.

10.1 Drilling









Procedure



1. The part program or ShopTurn program to be processed has been created and you are in the editor.
2. Press the "Drilling" softkey.
3. Press the "Thread" and "Cut thread" softkeys.
The "Drilling and thread milling" input window opens.

Parameters, G code program			Parameters, ShopTurn program		
PL 	Machining plane		T	Tool name	
RP	Retraction plane	mm	D	Cutting edge number	
SC	Safety clearance	mm	F 	Feedrate	mm/min mm/rev
			S / V 	Spindle speed or constant cutting rate	rpm m/min

Parameters	Description	Unit
Machining position (only for G code)	<ul style="list-style-type: none"> • Single position Drill hole at programmed position • Position pattern Position with MCALL 	
F1 (only for G code)	Drilling feedrate	mm/min mm/rev
Z0 (only for G code)	Reference point Z	mm
Machining surface (only for Shop-Turn)	<ul style="list-style-type: none"> • Face C • Face Y • Peripheral surface C • Peripheral surface Y 	
Position (only for Shop-Turn)	<ul style="list-style-type: none"> • At the front (face) • At the rear (face) • Outside (peripheral surface) • Inside (peripheral surface) 	
 (only for Shop-Turn)	Clamp/release spindle (only for end face Y/peripheral surface Y) The function must be set up by the machine manufacturer.	
Z1	Thread length (inc) or end point of the thread (abs)	mm

Parameters	Description	Unit
D	Maximum depth infeed	mm
DF 	<ul style="list-style-type: none"> Percentage for each additional infeed DF=100: Infeed increment remains constant DF<100: Infeed increment is reduced in direction of final drilling depth Z1. Example: last infeed 4 mm; DF 80% next infeed = 4 x 80% = 3.2 mm next but one infeed = 3.2 x 80% = 2.56 mm etc. Amount for each additional infeed 	% mm
V1	<p>Minimum infeed - (only for DF, percentage for each additional infeed)</p> <p>Parameter V1 is only available if DF < 100 has been programmed.</p> <p>If the infeed increment becomes very small, a minimum infeed can be programmed in parameter "V1".</p> <p>V1 < Infeed increment: The tool is inserted by the infeed increment</p> <p>V1 > Infeed increment: The tool is inserted by the infeed value programmed under V1.</p>	mm
Predrilling 	<p>Predrilling with reduced feedrate</p> <ul style="list-style-type: none"> Yes No <p>The reduced drilling feedrate is obtained as follows:</p> <p>Drilling feedrate $F1 < 0.15$ mm/rev: Predrilling feedrate = 30% of F1</p> <p>Drilling feedrate $F1 \geq 0.15$ mm/rev: Predrilling feedrate = 0.1 mm/rev</p>	
AZ (only for G code)	Predrilling depth with reduced drilling feedrate - ("yes", only for predrilling)	mm
Through boring 	<p>Remaining drilling depth with drilling feedrate</p> <ul style="list-style-type: none"> Yes No 	
ZR	Residual drilling depth for through boring - ("yes", only for through boring)	mm
FR 	Drilling feedrate for remaining drilling depth - ("yes", only for through boring)	mm/min mm/rev
Chip removal 	<p>Stock removal before thread milling</p> <ul style="list-style-type: none"> Yes No <p>Return to workpiece surface for stock removal before thread milling.</p>	
Thread 	<p>Direction of rotation of the thread</p> <ul style="list-style-type: none"> Righthand thread Lefthand thread 	
F2 	Feedrate for thread milling	mm/min mm/tooth
Table 	<p>Thread table selection:</p> <ul style="list-style-type: none"> without ISO metric Whitworth BSW Whitworth BSP UNC 	

10.1 Drilling

Parameters	Description	Unit
Selection - (not for table "Without") U	Selection, table value: e.g. <ul style="list-style-type: none"> • M3; M10; etc. (ISO metric) • W3/4"; etc. (Whitworth BSW) • G3/4"; etc. (Whitworth BSP) • N1" - 8 UNC; etc. (UNC) 	
P U - (selection only possible for "Table without selection")	Pitch ... <ul style="list-style-type: none"> • in MODULUS: $MODULUS = Pitch/\pi$ • in turns per inch: Used with pipe threads, for example. When entered per inch, enter the integer number in front of the decimal point in the first parameter field and the figures after the decimal point as a fraction in the second and third field. • in mm/rev • in inch/rev The pitch is determined by the tool used.	MODULUS Turns/" mm/rev in/rev
Z2	Retraction amount before thread milling The thread depth in the direction of the tool axis is defined using Z2. Z2 is relative to the tool tip.	mm
∅	Nominal diameter	mm
Milling direction U	<ul style="list-style-type: none"> • Climbing: Mill thread in one cycle. • Conventional: Mill thread in one cycle. • Climbing - conventional: Mill thread in two cycles: rough cutting is performed by conventional milling with defined allowances, then finish cutting is performed with climb milling with milling feedrate FS. 	
FS U	Finishing feedrate rate - (only for climbing - conventional milling)	mm/min mm/tooth

10.1.10 Positions and position patterns

Function

- Arbitrary positions
- Position on a line, on a grid or frame
- Position on a full or pitch circle

Programming a position pattern in ShopTurn

Several position patterns can be programmed in succession (up to 20 technologies and position patterns in total). They are executed in the order in which you program them.

Note

The number of positions that can be programmed in a "Positions" step is limited to a maximum of 600!

The programmed technologies and subsequently programmed positions are automatically linked by the control.

Displaying and hiding positions

You can display or hide any positions (Section "Displaying and hiding positions (Page 397)").

Approach/retraction

1. Within a position pattern, or while approaching the next position pattern, the tool is retracted to the retraction plane and the new position or position pattern is then approached at rapid traverse.
2. With subsequent technological operations (e.g. centering - drilling - tapping), the respective drilling cycle must be programmed after calling the next tool (e.g. drill) and immediately afterwards the call of the position pattern to be machined.

Tool traverse path

- ShopTurn
The programmed positions are machined with the previously programmed tool (e.g. center drill). Machining of the positions always starts at the reference point. In the case of a grid, machining is performed first in the direction of the 1st axis and then meandering back and forth. The frame and hole circle are machined counter-clockwise.
- G codes
For G code, for rows/frames/grids, a start is always made at the next corner of the frame or grid or the end of the row. The frame and circle or pitch circle are machined counter-clockwise.

Working with rotary axis

In the G code, the C axis is supported during drilling (any position pattern, full circle, and pitch circle).

With ShopTurn, the C axis is supported by the following selection options of the machining area:

- Face C
- Peripheral surface C

10.1.11 Arbitrary positions (CYCLE802)

Function

The "Arbitrary positions" function allows you to program any positions, i.e. in rectangular or polar coordinates. Individual positions are approached in the order in which you program them. Press "Delete all" softkey to delete all positions programmed in X/Y.

Rotary axis

ZC plane

You program in ZC to prevent the Y axis moving during machining.

To ensure that the holes point to the center of the "Cylinder", you must first position the Y axis centrally above the "Cylinder".

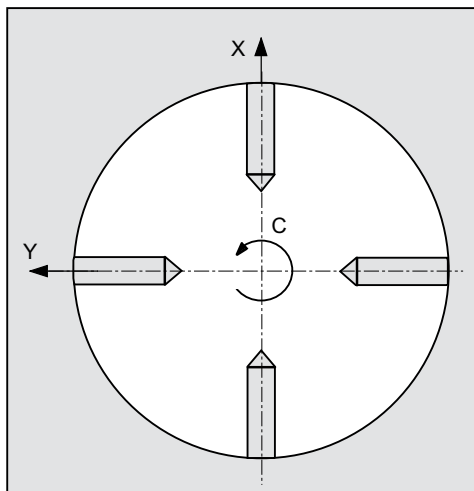

Figure 10-1 Y axis is centered above the cylinder

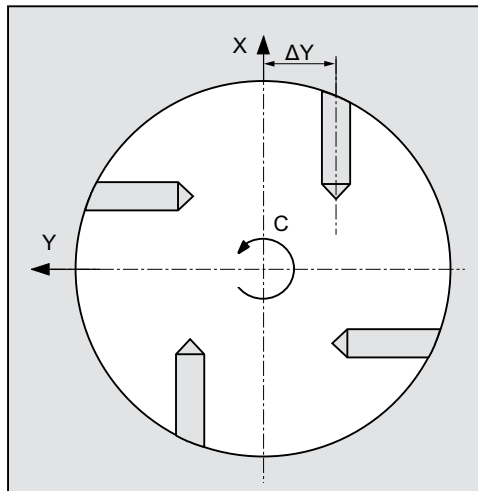

Figure 10-2 Y axis is not centered above the cylinder

YZC plane

You program in YZC if the Y axis should also move during machining. A value can be specified for each position.

In addition to the possibilities of ZC, the following is also possible, for example.

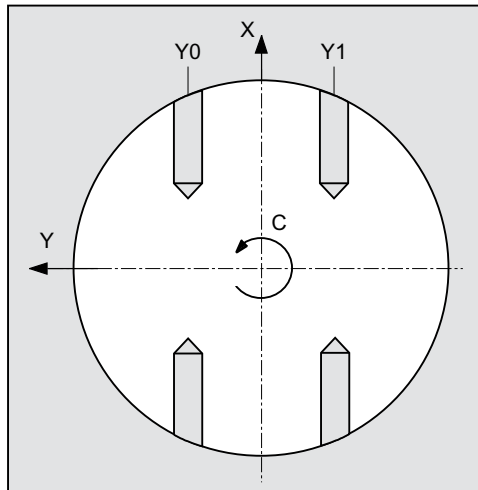

Figure 10-3 Y axis is traversed (Y0, Y1)























10.1 Drilling

Procedure















1. The part program or ShopTurn program to be processed has been created and you are in the editor.
2. Press the "Drilling" softkey.
3. Press the "Positions" and "Arbitrary positions" softkeys. The "Positions" input window opens.

Parameter	Description	Unit
LAB (only for G code)	Repeat jump label for position	
PL (only for G code)	Machining plane	
Axes (only for G code) 	<p>Selection of the participating axes</p> <ul style="list-style-type: none"> • XY (1st and 2nd axis of the plane) • ZC (rotary axis and assigned linear axis) • YZC (rotary axis and both axes of the plane) <p>Note: Rotary axes are only displayed in the selection field if they have been released for use in the position pattern. Please observe the information provided by your machine manufacturer.</p>	
Machining surface (only for Shop-Turn)	<ul style="list-style-type: none"> • Face C • Face Y • Face B • Peripheral surface C • Peripheral surface Y 	
Position (only for Shop-Turn)	<ul style="list-style-type: none"> • At the front (face) • At the rear (face) • Outside (peripheral surface) • Inside (peripheral surface) 	
Coordinate system (only for Shop-Turn)	<ul style="list-style-type: none"> • Right-angled or polar Dimensions in right-angled coordinates or polar coordinates (only for face C and face Y) • Right-angled or cylindrical Dimensions in right-angled coordinates or cylindrical coordinates - (only for peripheral surface C) 	

Parameter	Description	Unit
X0 Y0 X1  ...X8  Y1  ...Y8  (only for G code)	Axes XY (at right angles) X coordinate of 1st position (abs) Y coordinate of 1st position (abs) X coordinate for additional positions (abs or inc) Y coordinate for additional positions (abs or inc)	mm mm mm mm
Z0 C0 Z1  ... Z8  C1  ... C8  (only for G code)	Axes ZC (for G19) Z coordinate of 1st position (abs) C coordinate of 1st position (abs) Z coordinates for additional positions (abs or inc) C coordinates for additional positions (abs or inc)	mm Degrees mm Degrees
Y0 Z0 C0 Y1  ... Y5  Z1  ... Z5  C1  ...C5  (only for G code)	Axes YZC (for G19) Y coordinate of 1st position (abs) Z coordinate of 1st position (abs) C coordinate of 1st position Y coordinates of additional positions (abs or inc) Z coordinates for additional positions (abs or inc) C coordinates for additional positions (abs or inc)	mm mm Degrees mm mm Degrees
Z0 CP X0 Y0 X1  ... X7  Y1  ... Y7  (only for Shop-Turn)	Face C and face Y - at right angles Z coordinate of the reference point (abs) Positioning angle for machining area (only for face Y) Angle CP does not have any effect on the machining position in relation to the workpiece. It is only used to position the workpiece with the rotary axis C in such a way that machining is possible on the machine. X coordinate of 1st position (abs) Y coordinate of 1st position (abs) X coordinate for additional positions (abs or inc) Incremental dimension: The sign is also evaluated Y coordinate for additional positions (abs or inc) Incremental dimension: The sign is also evaluated	mm Degrees mm mm mm mm
Z0 CP C0 L0 C1  ... C7  L1  ... L7  (only for ShopTurn)	Face C and face Y - polar (ShopTurn: Z coordinate of the reference point (abs) Positioning angle for machining area (only for face Y) Angle CP does not have any effect on the machining position in relation to the workpiece. It is only used to position the workpiece with the rotary axis C in such a way that machining is possible on the machine. C coordinate of 1st position (abs) 1st position of hole with reference to Y axis (abs) C coordinate for additional positions (abs or inc) Incremental dimension: The sign is also evaluated Distance to position (abs or inc) Incremental dimension: The sign is also evaluated	mm Degrees Degrees mm Degrees mm

10.1 Drilling

Parameter	Description	Unit
	Peripheral surface C - at right angles	
X0	Cylinder diameter \varnothing (abs)	mm
Y0	Y coordinate of 1st position (abs)	mm
Z0	Z coordinate of 1st position (abs)	mm
Y1  ...Y7 	Y coordinate for additional positions (abs or inc) Incremental dimension: The sign is also evaluated	mm
Z1  ...Z7  (only for ShopTurn)	Z coordinate for additional positions (abs or inc) Incremental dimension: The sign is also evaluated	mm
	Peripheral surface C - cylindrical	
C0	C coordinate of 1st position (abs)	Degrees
Z0	1st position of hole with reference to Z axis (abs)	mm
C1  ...C7 	C coordinate for additional positions (abs or inc) Incremental dimension: The sign is also evaluated	Degrees
Z1  ... Z7  (only for ShopTurn)	Additional positions in the Z axis (abs or inc) Incremental dimension: The sign is also evaluated	mm
	Peripheral surface Y:	
X0	Reference point in X direction (abs)	mm
C0	Positioning angle for machining surface	Degrees
Y0	Y coordinate of 1st position (abs)	mm
Z0	Z coordinate of 1st position (abs)	mm
Y1  ...Y7 	Y coordinate for additional positions (abs or inc) Incremental dimension: The sign is also evaluated	mm
Z1  ...Z7  (only for ShopTurn)	Z coordinate for additional positions (abs or inc) Incremental dimension: The sign is also evaluated	mm

10.1.12 Row position pattern (HOLES1)

Function

You can program any number of positions at equal distances along a line using the "Row position pattern" function.

Procedure



1. The part program or ShopTurn program to be processed has been created and you are in the editor.
 2. Press the "Drilling" softkey.
 3. Press the "Positions" and "Row" softkeys.
- The "Position row" input window opens.

Parameter	Description	Unit
LAB (only for G code)	Repeat jump label for position	
PL (only for G code)	Machining plane	
Machining surface (only for Shop-Turn)	<ul style="list-style-type: none"> • Face C • Face Y • Peripheral surface C • Peripheral surface Y 	
Position (only for Shop-Turn)	<ul style="list-style-type: none"> • At the front (face) • At the rear (face) • Outside (peripheral surface) • Inside (peripheral surface) 	
X0 Y0 α 0 (only for G Code)	<p>X coordinate of the reference point X (abs) This position must be programmed absolutely in the 1st call.</p> <p>Y coordinate of the reference point Y (abs) This position must be programmed absolutely in the 1st call.</p> <p>Angle of rotation of the line referred to the X axis Positive angle: Line is rotated counter-clockwise. Negative angle: Line is rotated clockwise.</p>	mm mm Degrees
Z0 X0 Y0 α 0 (only for Shop-Turn)	<p>Face C:</p> <p>Z coordinate of the reference point (abs)</p> <p>X coordinate of the reference point – first position (abs)</p> <p>Y coordinate of the reference point – first position (abs)</p> <p>Angle of rotation of line in relation to the X axis Positive angle: Line is rotated counter-clockwise. Negative angle: Line is rotated clockwise.</p>	mm mm mm Degrees

10.1 Drilling

Parameter	Description	Unit
Z0	Face Y: Z coordinate of the reference point (abs)	mm
CP	Positioning angle for machining area Angle CP does not have any effect on the machining position in relation to the workpiece. It is only used to position the workpiece with the rotary axis C in such a way that machining is possible on the machine.	Degrees
X0	X coordinate of the reference point – first position (abs)	mm
Y0	Y coordinate of the reference point – first position (abs)	mm
α0 (only for Shop-Turn)	Angle of rotation of line in relation to the X axis Positive angle: Line is rotated counter-clockwise. Negative angle: Line is rotated clockwise.	Degrees
X0	Peripheral surface C: Cylinder diameter \varnothing (abs)	mm
Y0	Y coordinate of the reference point – first position (abs)	mm
Z0	Z coordinate of the reference point – first position (abs)	mm
α0 (only for Shop-Turn)	Angle of rotation of line with reference to Y axis Positive angle: Line is rotated counter-clockwise. Negative angle: Line is rotated clockwise.	Degrees
X0	Peripheral surface Y: X coordinate of the reference point (abs)	mm
C0	Positioning angle for machining surface	Degrees
Y0	Y coordinate of the reference point – first position (abs)	mm
Z0	Z coordinate of the reference point – first position (abs)	mm
α0 (only for Shop-Turn)	Angle of rotation of line with reference to Y axis Positive angle: Line is rotated counter-clockwise. Negative angle: Line is rotated clockwise.	Degrees
L0	Distance of the 1st position to reference point	mm
L	Distance between the positions	mm
N	Number of positions	

10.1.13 Grid or frame position pattern (CYCLE801)

Function

- You can use the "Grid position pattern" function (CYCLE801) to program any number of positions that are spaced at an equal distance along one or several parallel lines. If you want to program a rhombus-shaped grid, enter angle αX or αY .
- Frame
You can use the "Frame position pattern" function (CYCLE801) to program any number of positions that are spaced at an equal distance on a frame. The spacing may be different on both axes. If you want to program a rhombus-shaped frame, enter angle αX or αY .

Procedure



1. The part program or ShopTurn program to be processed has been created and you are in the editor.
2. Press the "Drilling" softkey.
3. Press the "Positions" softkey.
4. Press the "Grid" softkey.

- OR -
Press the "Frame" softkey.

The "Grid position" or "Frame position" input window opens.

Parameters - "Grid" position pattern



Parameter	Description	Unit
LAB (only for G code)	Repeat jump label for position	
PL (only for G code)	Machining plane	
Machining surface (only for Shop-Turn)	<ul style="list-style-type: none"> • Face C • Face Y • Peripheral surface C • Peripheral surface Y 	
Position (only for Shop-Turn)	<ul style="list-style-type: none"> • At the front (face) • At the rear (face) • Outside (peripheral surface) • Inside (peripheral surface) 	

10.1 Drilling

Parameter	Description	Unit
X0 Y0 α0 (only for G Code)	X coordinate of the reference point X (abs) This position must be programmed absolutely in the 1st call. Y coordinate of the reference point Y (abs) This position must be programmed absolutely in the 1st call. Angle of rotation of the line referred to the X axis Positive angle: Line is rotated counter-clockwise. Negative angle: Line is rotated clockwise.	mm mm Degrees
Z0 X0 Y0 α0 (only for Shop-Turn)	Face C: Z coordinate of the reference point (abs) X coordinate of the reference point – first position (abs) Y coordinate of the reference point – first position (abs) Angle of rotation of line in relation to the X axis Positive angle: Line is rotated counter-clockwise. Negative angle: Line is rotated clockwise.	mm mm mm Degrees
Z0 CP X0 Y0 α0 (only for Shop-Turn)	Face Y: Z coordinate of the reference point (abs) Positioning angle for machining area The CP angle does not have any effect on the machining position in relation to the workpiece. It is only used to position the workpiece with the rotary axis C in such a way that machining is possible on the machine. X coordinate of the reference point – first position (abs) Y coordinate of the reference point – first position (abs) Angle of rotation of line in relation to the X axis Positive angle: Line is rotated counter-clockwise. Negative angle: Line is rotated clockwise.	mm Degrees mm mm Degrees
X0 Y0 Z0 α0 (only for Shop-Turn)	Peripheral surface C: Cylinder diameter \varnothing (abs) Y coordinate of the reference point – first position (abs) Z coordinate of the reference point – first position (abs) Angle of rotation of line with reference to Y axis Positive angle: Line is rotated counter-clockwise. Negative angle: Line is rotated clockwise.	mm mm mm Degrees

Parameter	Description	Unit
	Peripheral surface Y:	
X0	X coordinate of the reference point (abs)	mm
C0	Positioning angle for machining surface	Degrees
Y0	Y coordinate of the reference point – first position (abs)	mm
Z0	Z coordinate of the reference point – first position (abs)	mm
$\alpha 0$ (only for Shop-Turn)	Angle of rotation of line with reference to Y axis Positive angle: Line is rotated counter-clockwise. Negative angle: Line is rotated clockwise.	Degrees
αX	Shear angle X	Degrees
αY	Shear angle Y	Degrees
L1	Distance between columns	mm
L2	Distance between rows	mm
N1	Number of columns	
N2	Number of rows	

Parameters - "Frame" position pattern

Parameter	Description	Unit
LAB (only for G code)	Repeat jump label for position	
PL  (only for G code)	Machining plane	
Machining surface  (only for Shop-Turn)	<ul style="list-style-type: none"> • Face C • Face Y • Peripheral surface C • Peripheral surface Y 	
Position  (only for Shop-Turn)	<ul style="list-style-type: none"> • At the front (face) • At the rear (face) • Outside (peripheral surface) • Inside (peripheral surface) 	
X0 Y0 $\alpha 0$ (only for G Code)	X coordinate of the reference point X (abs) This position must be programmed absolutely in the 1st call. Y coordinate of the reference point Y (abs) This position must be programmed absolutely in the 1st call. Angle of rotation of the line referred to the X axis Positive angle: Line is rotated counter-clockwise. Negative angle: Line is rotated clockwise.	mm mm Degrees

10.1 Drilling

Parameter	Description	Unit
Z0 X0 Y0 $\alpha 0$ (only for Shop-Turn)	Face C: Z coordinate of the reference point (abs) X coordinate of the reference point – first position (abs) Y coordinate of the reference point – first position (abs) Angle of rotation of line in relation to the X axis Positive angle: Line is rotated counter-clockwise. Negative angle: Line is rotated clockwise.	mm mm mm Degrees
Z0 CP X0 Y0 $\alpha 0$ (only for Shop-Turn)	Face Y: Z coordinate of the reference point (abs) Positioning angle for machining area The CP angle does not have any effect on the machining position in relation to the work-piece. It is only used to position the workpiece with the rotary axis C in such a way that machining is possible on the machine. X coordinate of the reference point – first position (abs) Y coordinate of the reference point – first position (abs) Angle of rotation of line in relation to the X axis Positive angle: Line is rotated counter-clockwise. Negative angle: Line is rotated clockwise.	mm Degrees mm mm Degrees
X0 Y0 Z0 $\alpha 0$ (only for Shop-Turn)	Peripheral surface C: Cylinder diameter \varnothing (abs) Y coordinate of the reference point – first position (abs) Z coordinate of the reference point – first position (abs) Angle of rotation of line with reference to Y axis Positive angle: Line is rotated counter-clockwise. Negative angle: Line is rotated clockwise.	mm mm mm Degrees
X0 C0 Y0 Z0 $\alpha 0$ (only for Shop-Turn)	Peripheral surface Y: X coordinate of the reference point (abs) Positioning angle for machining surface Y coordinate of the reference point – first position (abs) Z coordinate of the reference point – first position (abs) Angle of rotation of line with reference to Y axis Positive angle: Line is rotated counter-clockwise. Negative angle: Line is rotated clockwise.	mm Degrees mm mm Degrees
L0 L N	Distance of the 1st position to reference point Distance between the positions Number of positions	mm mm
αX αY L1 L2 N1 N2	Shear angle X Shear angle Y Distance between columns Distance between rows Number of columns Number of rows	Degrees Degrees mm mm

10.1.14 Circle or pitch circle position pattern (HOLES2)

Function

You can program holes on a full circle or a pitch circle of a defined radius with the "Circle position pattern" and "Pitch circle position pattern" functions. The basic angle of rotation (α_0) for the 1st position is relative to the X axis. The control calculates the angle of the next hole position as a function of the total number of holes. The angle it calculates is identical for all positions.

The tool can approach the next position along a linear or circular path.

Rotary axes

If rotary axes are set up on your machine, you can select these axes for the "circle" or "pitch circle" position patterns.



Machine manufacturer

Please observe the information provided by the machine manufacturer.

Procedure



1. The part program or ShopTurn program to be processed has been created and you are in the editor.
2. Press the "Drilling" softkey.
3. Press the "Positions" softkey.
4. Press the "Circle" softkey.

- OR -





Press the "Pitch circle" softkey.





The "Position circle" or "Position pitch circle" input window is opened.

Parameters - "Circle" position pattern

Parameter	Description	Unit
LAB (only for G code)	Repeat jump label for position	
PL  (only for G code)	Machining plane	

10.1 Drilling



Parameter	Description	Unit
Axes  (only for G code)	Selection of the participating axes: <ul style="list-style-type: none"> • XY (1st and 2nd axis of the plane) • ZC (rotary axis and assigned linear axis) Note: Rotary axes are only displayed in the selection field if they have been released for use in the position pattern. Please observe the information provided by your machine manufacturer.	
X0 Y0 α0 R N Positioning  (only for G code)	Axes XY (at right angles) X coordinate of the reference point (abs) Y coordinate of the reference point (abs) Starting angle for first position referred to the X axis. Positive angle: Circle is rotated counter-clockwise. Negative angle: Circle is rotated clockwise. Radius Number of positions <ul style="list-style-type: none"> • Straight line: Next position is approached linearly in rapid traverse. • Circular: Next position is approached along a circular path at the feedrate defined in the machine data. 	mm mm Degrees mm
Z0 C0 N (only for G code)	Axes ZC (G19) Z coordinate of the reference point (abs) Start angle of the C axis (abs) Number of positions	mm Degrees
Machining surface  (only for Shop-Turn)	<ul style="list-style-type: none"> • Face C • Face Y • Peripheral surface C • Peripheral surface Y 	
Position  (only for Shop-Turn)	<ul style="list-style-type: none"> • At the front (face) • At the rear (face) • Outside (peripheral surface) • Inside (peripheral surface) 	
Position  (only for Shop-Turn)	Selection options for the following positions - (only for face C/Y) <ul style="list-style-type: none"> • center • off-center 	





Parameter	Description	Unit
center/ off-center Z0 X0 Y0 $\alpha 0$ R N Positioning  (only for Shop-Turn)	<p>Face C:</p> <p>Position circle center on the face surface</p> <p>Position circle off-center on the face surface</p> <p>Z coordinate of the reference point (abs)</p> <p>X coordinate of the reference point (abs) – (only for off-center)</p> <p>Y coordinate of the reference point (abs) – (only for off-center)</p> <p>Starting angle for first position referred to the X axis.</p> <p>Positive angle: Circle is rotated counter-clockwise.</p> <p>Negative angle: Circle is rotated clockwise.</p> <p>Radius</p> <p>Number of positions</p> <ul style="list-style-type: none"> • Straight line: Next position is approached linearly in rapid traverse. • Circular: Next position is approached along a circular path at the feedrate defined in the machine data. 	mm mm mm Degrees mm
center/ off-center Z0 CP X0 or L0  Y0 or C0  $\alpha 0$ R N Positioning  (only for Shop-Turn)	<p>Face Y:</p> <p>Position circle center on the face surface</p> <p>Position circle off-center on the face surface</p> <p>Z coordinate of the reference point (abs)</p> <p>Positioning angle for machining area</p> <p>The CP angle does not have any effect on the machining position in relation to the workpiece. It is only used to position the workpiece with the rotary axis C in such a way that machining is possible on the machine.</p> <p>X coordinate of the reference point (abs) or reference point length, polar – (only for off-center)</p> <p>Y coordinate of the reference point (abs) or reference point angle, polar – (only for off-center)</p> <p>Starting angle for first position referred to the X axis.</p> <p>Positive angle: Circle is rotated counter-clockwise.</p> <p>Negative angle: Circle is rotated clockwise.</p> <p>Radius</p> <p>Number of positions</p> <ul style="list-style-type: none"> • Straight line: Next position is approached linearly in rapid traverse. • Circular: Next position is approached along a circular path at the feedrate defined in the machine data. 	mm Degrees mm mm Degrees Degrees mm

10.1 Drilling





Parameter	Description	Unit
X0 Z0 $\alpha 0$ N (only for Shop-Turn)	Peripheral surface C: Cylinder diameter \varnothing (abs) Z coordinate of the reference point (abs) Starting angle for first position referred to the Y axis. Positive angle: Circle is rotated counter-clockwise. Negative angle: Circle is rotated clockwise. Number of positions	mm mm Degrees
X0 C0 Y0 Z0 $\alpha 0$ N R Positioning  (only for Shop-Turn)	Peripheral surface Y: X coordinate of the reference point (abs) Positioning angle for machining surface Y coordinate of the reference point (abs) Z coordinate of the reference point (abs) Starting angle for first position referred to the Y axis. Positive angle: Circle is rotated counter-clockwise. Negative angle: Circle is rotated clockwise. Number of positions Radius <ul style="list-style-type: none"> • Straight line: Next position is approached linearly in rapid traverse. • Circular: Next position is approached along a circular path at the feedrate defined in the machine data. 	mm Degrees mm mm Degrees mm

Parameters - "Pitch circle" position pattern

Parameter	Description	Unit
LAB (only for G code)	Repeat jump label for position	
PL  (only for G code)	Machining plane	
Axes  (only for G code)	Selection of the participating axes: <ul style="list-style-type: none"> • XY (1st and 2nd axis of the plane) • ZC (rotary axis and assigned linear axis) <p>Note: Rotary axes are only displayed in the selection field if they have been released for use in the position pattern. Please observe the information provided by your machine manufacturer.</p>	

Parameter	Description	Unit
X0 Y0 $\alpha 0$ $\alpha 1$ R N Positioning  (only for G code)	Axes XY (at right angles) X coordinate of the reference point (abs) Y coordinate of the reference point (abs) Starting angle for first position referred to the X axis. Positive angle: Circle is rotated counter-clockwise. Negative angle: Circle is rotated clockwise. Incrementing angle Radius Number of positions <ul style="list-style-type: none"> • Straight line: Next position is approached linearly in rapid traverse. • Circular: Next position is approached along a circular path at the feedrate defined in the machine data. 	mm mm Degrees Degrees mm
Z0 C0 N (only for G code)	Axes ZC (with G19) Z coordinate of the reference point (abs) Start angle of the C axis (abs) Number of positions	mm Degrees
Machining surface  (only for Shop-Turn)	<ul style="list-style-type: none"> • Face C • Face Y • Peripheral surface C • Peripheral surface Y 	
Position  (only for Shop-Turn)	<ul style="list-style-type: none"> • At the front (face) • At the rear (face) • Outside (peripheral surface) • Inside (peripheral surface) 	
Position  (only for Shop-Turn)	Selection options for the following positions - (only for face C/Y) <ul style="list-style-type: none"> • center • off-center 	
center/ off-center Z0 X0 Y0 $\alpha 0$ $\alpha 1$ R N Positioning  (only for Shop-Turn)	Face C: Position circle center on the face surface Position circle off-center on the face surface Z coordinate of the reference point (abs) X coordinate of the reference point (abs) – (only for off-center) Y coordinate of the reference point (abs) – (only for off-center) Starting angle for first position referred to the X axis. Positive angle: Circle is rotated counter-clockwise. Negative angle: Circle is rotated clockwise. Incrementing angle Radius Number of positions <ul style="list-style-type: none"> • Straight line: Next position is approached linearly in rapid traverse. • Circular: Next position is approached along a circular path at the feedrate defined in the machine data. 	mm mm mm Degrees Degrees mm

10.1 Drilling

Parameter	Description	Unit
center/ off-center Z0 CP X0 or L0  Y0 or C0  α0 α1 R N Positioning  (only for Shop-Turn)	<p>Face Y:</p> <p>Position circle center on the face surface</p> <p>Position circle off-center on the face surface</p> <p>Z coordinate of the reference point (abs)</p> <p>Positioning angle for machining area</p> <p>The CP angle does not have any effect on the machining position in relation to the workpiece. It is only used to position the workpiece with the rotary axis C in such a way that machining is possible on the machine.</p> <p>X coordinate of the reference point (abs) or reference point length, polar – (only for off-center)</p> <p>Y coordinate of the reference point (abs) or reference point angle, polar – (only for off-center)</p> <p>Starting angle for first position referred to the X axis.</p> <p>Positive angle: Circle is rotated counter-clockwise.</p> <p>Negative angle: Circle is rotated clockwise.</p> <p>Incrementing angle</p> <p>Radius</p> <p>Number of positions</p> <ul style="list-style-type: none"> • Straight line: Next position is approached linearly in rapid traverse. • Circular: Next position is approached along a circular path at the feedrate defined in the machine data. 	mm Degrees mm Degrees Degrees Degrees mm
X0 Z0 α0 α1 N (only for Shop-Turn)	<p>Peripheral surface C:</p> <p>Cylinder diameter \varnothing (abs)</p> <p>Z coordinate of the reference point (abs)</p> <p>Starting angle for first position referred to the Y axis.</p> <p>Positive angle: Circle is rotated counter-clockwise.</p> <p>Negative angle: Circle is rotated clockwise.</p> <p>Incrementing angle</p> <p>Number of positions</p>	mm mm Degrees Degrees
X0 C0 Y0 Z0 α0 α1 N R Positioning  (only for Shop-Turn)	<p>Peripheral surface Y:</p> <p>X coordinate of the reference point (abs)</p> <p>Positioning angle for machining surface</p> <p>Y coordinate of the reference point (abs)</p> <p>Z coordinate of the reference point (abs)</p> <p>Starting angle for first position referred to the Y axis.</p> <p>Positive angle: Circle is rotated counter-clockwise.</p> <p>Negative angle: Circle is rotated clockwise.</p> <p>Incrementing angle</p> <p>Number of positions</p> <p>Radius</p> <ul style="list-style-type: none"> • Straight line: Next position is approached linearly in rapid traverse. • Circular: Next position is approached along a circular path at the feedrate defined in the machine data. 	mm Degrees mm mm Degrees Degrees mm

10.1.15 Displaying and hiding positions

Function

You can hide any positions in the following position patterns:

- Position pattern line
- Position pattern grid
- Position pattern frame
- Full circle position pattern
- Pitch circle position pattern

The hidden positions are skipped when machining.

Display

The programmed positions of the position pattern are shown as follows in the programming graphic:

- x Position is activated = displayed (position is shown as a cross)
- o Position deactivated = hidden (position shown as a circle)

Selecting positions

You have the option of either displaying or hiding positions - by activating the checkbox in the displayed position table either using the keyboard or mouse.

Procedure:



1. The part program or ShopTurn program to be processed has been created and you are in the editor.
2. Press the "Drilling" and "Positions" softkeys.
3. Press the "Line/Grid/Frame" or "Full/Pitch Circle" softkeys.



4. Press the "Hide position" softkey.
The "Hide position" window opens on top of the input form of the position pattern.
The positions are displayed in a table.
The numbers of the positions, their coordinates (X, Y) as well as a checkbox with the state (activated = on / deactivated = off) are displayed.
The actual position in the graphic is highlighted in color.
5. Using the mouse, select the required position and deactivate or activate the checkbox in order to hide the position or display it again.
In the diagram, skipped positions are shown in the form of a circle and displayed (active) positions are shown in the form of a cross.
Note: You have the option of selecting individual positions using the <Cursor up> or <Cursor down> keys – and hiding and displaying using the <SELECT> key.

Display or hide all positions at once



1. Press the "Hide all" softkey to hide all positions.



2. Press the "Show all" softkey to display all positions again.

10.1.16 Repeating positions

Function

If you want to approach positions that you have already programmed again, you can do this quickly with the function "Repeat position".

You must specify the number of the position pattern. The cycle automatically assigns this number (for ShopTurn). You will find this position pattern number in the work plan (program view) or G-code program after the block number.

Procedure



1. The part program or ShopTurn program to be processed has been created and you are in the editor.
2. Press the "Drilling", and "Repeat position" softkeys.
The "Repeat positions" input window opens.



3. After you have entered the label or the position pattern number, e.g. 1, press the "Accept" softkey. The position pattern you have selected is then approached again.

Parameter	Description	Unit
LAB (only for G code)	Repeat jump label for position	
Position (only for ShopTurn)	Enter the number of the position pattern	

10.2 Rotate

10.2.1 General

In all turning cycles apart from contour turning (CYCLE95), in the combined roughing and finishing mode, when finishing it is possible to reduce the feedrate as a percentage.



Machine manufacturer

Please also refer to the machine manufacturer's specifications.

10.2.2 Stock removal (CYCLE951)

Function

You can use the "Stock removal" cycle for longitudinal or transverse stock removal of corners at outer or inner contours.

Note

Removing stock from corners

For this cycle, the safety clearance is additionally limited using setting data. The lower value is taken for machining.

Please refer to the machine manufacturer's specifications.

Machining method

- **Roughing**

In roughing applications, paraxial cuts are machined to the finishing allowance that has been programmed. If no finishing allowance has been programmed, the workpiece is roughed down to the final contour.

During roughing, the cycle reduces the programmed infeed depth D if necessary so that it is possible for cuts of an equal size to be made. For example, if the overall infeed depth is 10 and you have specified an infeed depth of 3, this would result in cuts of 3, 3, 3 and 1. The cycle would reduce the infeed depth to 2.5 to create 4 equally sized cuts.

The angle between the contour and the tool cutting edge determines whether the tool rounds the contour at the end of each cut by the infeed depth D, in order to remove residual corners, or is raised immediately. The angle beyond which rounding is performed is stored in a machine data element.



Machine manufacturer

Please also refer to the machine manufacturer's instructions.

If the tool does not round the corner at the end of the cut, it is raised by the safety distance or a value specified in the machine data at rapid traverse. The cycle always observes the lower value; otherwise, stock removal at inner contours, for example, could cause the contour to be damaged.



Machine manufacturer

Please also refer to the machine manufacturer's instructions.

- **Finishing**
Finishing is performed in the same direction as roughing. The cycle automatically selects and deselects tool radius compensation during finishing.

Approach/retraction

1. The tool first moves at rapid traverse to the starting point of the machining operation calculated internally in the cycle (reference point + safety distance).
2. The tool moves to the first infeed depth at rapid traverse.
3. The first cut is made at machining feedrate.
4. The tool rounds the contour at machining feedrate or is raised at rapid traverse (see "Roughing").
5. The tool is moved at rapid traverse to the starting point for the next infeed depth.
6. The next cut is made at machining feedrate.
7. Steps 4 to 6 are repeated until the final depth is reached.
8. The tool moves back to the safety distance at rapid traverse.

Procedure





1. The part program or ShopTurn program to be processed has been created and you are in the editor.
2. Press the "Turning" softkey.
3. Press the "Stock removal" softkey.
The "Stock Removal" input window opens.
4. Select one of the three stock removal cycles via the softkeys:
Simple straight stock removal cycle.
The "Stock removal 1" input window opens.
- OR
Straight stock removal cycle with radii or chamfers.
The "Stock removal 2" input window opens.
- OR
Stock removal cycle with oblique lines, radii, or chamfers.
The "Stock Removal 3" input window opens.

10.2 Rotate

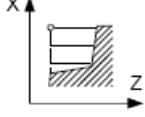
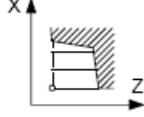
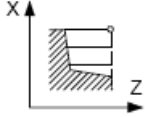
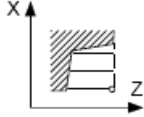
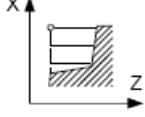
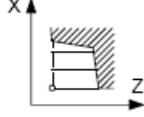
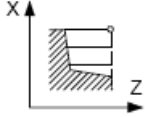
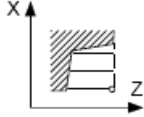
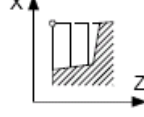
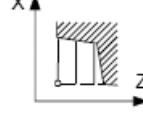
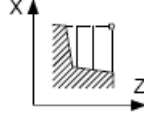
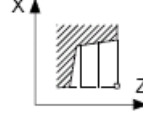
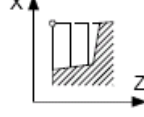
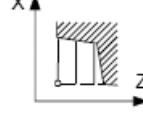
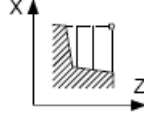
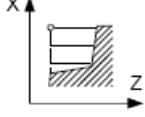
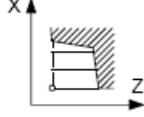
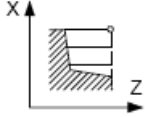
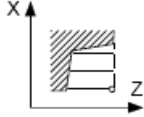
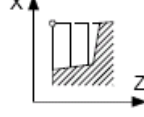
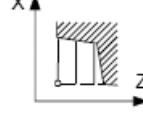
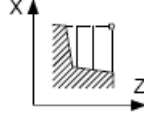
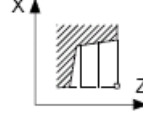
G code program parameters			ShopTurn program parameters		
PL	Machining plane		T	Tool name	
SC	Safety clearance	mm	D	Cutting edge number	
F	Feedrate	*	F	Feedrate	mm/rev
			S / V	Spindle speed or constant cutting rate	rpm m/min

Parameter	Description	Unit											
Machining U	<ul style="list-style-type: none"> ▽ (roughing) ▽▽▽ (finishing) 												
Position U	Machining position: 												
Machining direction U	Stock removal direction (transverse or longitudinal) in the coordinate system												
	Parallel to the Z axis (longitudinal) <table border="1" style="width:100%; text-align:center;"> <tr> <td>outside</td> <td>inside</td> </tr> <tr> <td></td> <td></td> </tr> <tr> <td></td> <td></td> </tr> </table>	outside	inside					Parallel to the X axis (transverse) <table border="1" style="width:100%; text-align:center;"> <tr> <td>outside</td> <td>Inside</td> </tr> <tr> <td></td> <td></td> </tr> <tr> <td></td> <td></td> </tr> </table>	outside	Inside			
outside	inside												
													
													
outside	Inside												
													
													
X0	Reference point in X Ø (abs, always diameter)	mm											
Z0	Reference point in Z (abs)	mm											
X1 U	End point X (abs) or end point X in relation to X0 (inc)												
Z1 U	End point Z (abs) or end point Z in relation to Z0 (inc)												
D	Maximum depth infeed – (not for finishing)	mm											
UX	Finishing allowance in X – (not for finishing)	mm											
UZ	Finishing allowance in Z – (not for finishing)	mm											
FS1...FS3 or R1...R3 U	Chamfer width (FS1...FS3) or rounding radius (R1...R3) - (not for stock removal 1)	mm											

Parameter	Description	Unit
	Parameter selection of intermediate point The intermediate point can be determined through position specification or angle. The following combinations are possible - (not for stock removal 1 and 2) <ul style="list-style-type: none"> • XM ZM • XM α1 • XM α2 • α1 ZM • α2 ZM • α1 α2 	
XM 	Intermediate point X \varnothing (abs) or intermediate point X in relation to X0 (inc)	mm
ZM 	Intermediate point Z (abs or inc)	mm
α 1	Angle of the 1st edge	Degrees
α 2	Angle of the 2nd edge	Degrees

* Unit of feedrate as programmed before the cycle call

10.2.3 Groove (CYCLE930)

Function

You can use the "Groove" cycle to machine symmetrical and asymmetrical grooves on any straight contour elements.

You have the option of machining outer or inner grooves, longitudinally or transversely (face). Use the "Groove width" and "Groove depth" parameters to determine the shape of the groove. If a groove is wider than the active tool, it is machined in several cuts. The tool is moved by a maximum of 80% of the tool width for each groove.

You can specify a finishing allowance for the groove base and the flanks; roughing is then performed down to this point.

The dwell time between recessing and retraction is stored in a setting data element.



Machine manufacturer

Please also refer to the machine manufacturer's specifications.

Approach/retraction during roughing

Infeed depth $D > 0$

1. The tool first moves to the starting point calculated internally in the cycle at rapid traverse.
2. The tool cuts a groove in the center of infeed depth D .
3. The tool moves back by $D + \text{safety clearance}$ with rapid traverse.
4. The tool cuts a groove next to the first groove with infeed depth $2 \cdot D$.
5. The tool moves back by $D + \text{safety clearance}$ with rapid traverse.





10.2 Rotate

6. The tool cuts alternating in the first and second groove with the infeed depth $2 \cdot D$, until the final depth T1 is reached.
Between the individual grooves, the tool moves back by $D + \text{safety clearance}$ with rapid traverse. After the last groove, the tool is retracted at rapid traverse to the safety distance.
7. All subsequent groove cuts are made alternating and directly down to the final depth T1.
Between the individual grooves, the tool moves back to the safety distance at rapid traverse.





Approach/retraction during finishing

1. The tool first moves to the starting point calculated internally in the cycle at rapid traverse.
2. The tool moves at the machining feedrate down one flank and then along the bottom to the center.
3. The tool moves back to the safety distance at rapid traverse.
4. The tool moves at the machining feedrate along the other flank and then along the bottom to the center.
5. The tool moves back to the safety distance at rapid traverse.

Procedure

1. The part program or ShopTurn program to be processed has been created and you are in the editor.
2. Press the "Turning" softkey.
 
3. Press the "Groove" softkey.
 
4. Select one of the three groove cycles with the softkey:
 - Simple groove cycle

 The "Groove 1" input window opens.
 - OR
 - Groove cycle with inclines, radii, or chamfers.

 The "Groove 2" input window opens.
 - OR
 - Groove cycle on an incline with inclines, radii or chamfers.

 The "Groove 3" input window opens.

Parameters, G code program			Parameters, ShopTurn program		
PL	Machining plane		T	Tool name	
SC	Safety clearance	mm	D	Cutting edge number	
F	Feedrate	*	F	Feedrate	mm/rev
			S / V	Spindle speed or constant cutting rate	rpm m/min

Parameter	Description	Unit
Machining 	<ul style="list-style-type: none"> • ∇ (roughing) • $\nabla\nabla\nabla$ (finishing) • $\nabla + \nabla\nabla\nabla$ (roughing and finishing) 	
Position 	Groove position: 	
X0	Reference point in X \emptyset	mm
Z0	Reference point in Z	mm
B1	Groove width	mm
T1	Groove depth \emptyset (abs) or groove depth referred to X0 or Z0 (inc)	mm
D	<ul style="list-style-type: none"> • Maximum depth infeed for insertion – (only for ∇ and $\nabla + \nabla\nabla\nabla$) • For zero: Insertion in a cut – (only for ∇ and $\nabla + \nabla\nabla\nabla$) D = 0: 1. cut is made directly to final depth T1 D > 0: 1st and 2nd cuts are made alternately to infeed depth D, in order to achieve a better chip flow and prevent the tool from breaking, refer to approaching/retraction when roughing. Alternate cutting is not possible if the tool can only reach the groove base at one position.	mm
UX or U 	Finishing allowance in X or finishing allowance in X and Z – (only for ∇ and $\nabla + \nabla\nabla\nabla$)	mm
UZ	Finishing allowance in Z – (for UX, only for ∇ and $\nabla + \nabla\nabla\nabla$)	mm
N	Number of grooves (N = 1...65535)	
DP	Distance between grooves (inc) DP is not displayed when N = 1	mm
$\alpha 1, \alpha 2$	Flank angle 1 or flank angle 2 - (only for grooves 2 and 3) Asymmetric grooves can be described by separate angles. The angles can be between 0 and < 90°.	Degrees
FS1...FS4 or R1...R4 	Chamfer width (FS1...FS4) or rounding radius (R1...R4) - (only for grooves 2 and 3)	mm
$\alpha 0$	Angle of the incline – (only for groove 3)	Degrees

* Unit of feedrate as programmed before the cycle call

10.2.4 Undercut form E and F (CYCLE940)

Function

You can use the "Undercut form E" or "Undercut form F" cycle to turn form E or F undercuts in accordance with DIN 509.

Approach/retraction

1. The tool first moves to the starting point calculated internally in the cycle at rapid traverse.
2. The undercut is made in one cut at the machining feedrate, starting from the flank through to the cross-feed VX.
3. The tool moves back to the starting point at rapid traverse.

Procedure

1. The part program or ShopTurn program to be processed has been created and you are in the editor.
2. Press the "Turning" softkey.
3. Press the "Undercut" softkey.









The "Undercut" input window opens.
4. Select one of the following undercut cycles via the softkeys:

Press the "Undercut form E" softkey.
The "Undercut form E (DIN 509)" input window opens.

- OR







Press the "Undercut form F" softkey.
The "Undercut form F (DIN 509)" input window opens.

Parameters, G code program (undercut, form E)			Parameters, ShopTurn program (undercut, form E)		
PL	Machining plane		T	Tool name	
SC	Safety clearance	mm	D	Cutting edge number	
F	Feedrate	*	F	Feedrate	mm/rev
			S / V	Spindle speed or constant cutting rate	rpm m/min



Parameters	Description	Unit
Position 	Form E machining position:    	
	Undercut size according to DIN table: E.g.: E1.0 x 0.4 (undercut form E)	
X0	Reference point X \emptyset	mm
Z0	Reference point Z	mm
X1	Allowance in X \emptyset (abs) or allowance in X (inc)	mm
		
VX 	Cross feed \emptyset (abs) or cross feed (inc)	mm

* Unit of feedrate as programmed before the cycle call

Parameters, G code program (undercut, form F)			Parameters, ShopTurn program (undercut, form F)		
PL	Machining plane		T	Tool name	
SC	Safety clearance	mm	D	Cutting edge number	
F	Feedrate	*	F	Feedrate	mm/rev
			S / V 	Spindle speed or constant cutting rate	rpm m/min

Parameters	Description	Unit
Position 	Form F machining position:    	
	Undercut size according to DIN table: e.g.: F0.6 x 0.3 (undercut form F)	
X0	Reference point X \emptyset	mm
Z0	Reference point Z	mm

10.2 Rotate

Parameters	Description	Unit
X1 	Allowance in X Ø (abs) or allowance in X (inc)	mm
Z1 	Allowance in Z (abs) or allowance in Z (inc) – (for undercut form F only)	mm
VX 	Cross feed Ø (abs) or cross feed (inc)	mm

* Unit of feedrate as programmed before the cycle call

10.2.5 Thread undercuts (CYCLE940)

Function



The "Thread undercut DIN" or "Thread undercut" cycle is used to program thread undercuts to DIN 76 for workpieces with a metric ISO thread, or freely definable thread undercuts.

Approach/retraction

1. The tool first moves to the starting point calculated internally in the cycle at rapid traverse.
2. The first cut is made at the machining feedrate, starting from the flank and traveling along the shape of the thread undercut as far as the safety distance.
3. The tool moves to the next starting position at rapid traverse.
4. Steps 2 and 3 are repeated until the thread undercut is finished.
5. The tool moves back to the starting point at rapid traverse.

During finishing, the tool travels as far as cross-feed VX.

Procedure

1. The part program or ShopTurn program to be processed has been created and you are in the editor.
2. Press the "Turning" softkey.
 
3. Press the "Undercut" softkey.
 
4. Press the "Thread undercut DIN" softkey.
 











The "Thread Undercut (DIN 76)" input window opens.

- OR -

 Press the "Thread undercut" softkey.
 

The "Thread Undercut" input window opens.









Parameters, G code program (undercut, thread DIN)			Parameters, ShopTurn program (undercut, thread DIN)		
PL	Machining plane		T	Tool name	
SC	Safety clearance	mm	D	Cutting edge number	
F	Feedrate	*	F	Feedrate	mm/rev
			S / V	Spindle speed or constant cutting rate	rpm m/min

Parameters	Description	Unit
Machining 	<ul style="list-style-type: none"> ▽ (roughing) ▽▽▽ (finishing) ▽ + ▽▽▽ (roughing and finishing) 	
Position 	Machining position:    	
Machining direction 	<ul style="list-style-type: none"> Longitudinal Parallel to the contour 	
Form 	<ul style="list-style-type: none"> Normal (form A) Short (form B) 	
P 	Thread pitch (select from the preset DIN table or enter)	mm/rev
X0	Reference point X \emptyset	mm
Z0	Reference point Z	mm
α	Insertion angle	Degrees
VX 	Cross feed \emptyset (abs) or cross feed (inc) - (only for ▽▽▽ and ▽ + ▽▽▽)	mm
D	Maximum depth infeed – (only for ▽ and ▽ + ▽▽▽)	mm
U or UX 	Finishing allowance in X or finishing allowance in X and Z – (only for ▽ and ▽ + ▽▽▽)	mm
UZ	Finishing allowance in Z – (only for UX, ▽ and ▽ + ▽▽▽)	mm

* Unit of feedrate as programmed before the cycle call

10.2 Rotate

Parameters, G code program (undercut, thread)			Parameters, ShopTurn program (undercut, thread)		
PL	Machining plane		T	Tool name	
SC	Safety clearance	mm	D	Cutting edge number	
F	Feedrate	*	F	Feedrate	mm/rev
			S / V	Spindle speed or constant cutting rate	rpm m/min

Parameters	Description	Unit
Machining 	<ul style="list-style-type: none"> ▽ (roughing) ▽▽▽ (finishing) ▽ + ▽▽▽ (roughing and finishing) 	
Machining direction 	<ul style="list-style-type: none"> Longitudinal Parallel to the contour 	
Position 	Machining position: 	
X0	Reference point X Ø	mm
Z0	Reference point Z	mm
X1 	Undercut depth referred to X Ø (abs) or undercut depth referred to X (inc)	mm
Z1 	Allowance Z (abs or inc)	mm
R1	Rounding radius 1	mm
R2	Rounding radius 2	mm
α	Insertion angle	Degrees
VX 	Cross feed Ø (abs) or cross feed (inc) - (only for ▽▽▽ and ▽ + ▽▽▽)	
D	Maximum depth infeed – (only for ▽ and ▽ + ▽▽▽)	mm
U or UX 	Finishing allowance in X or finishing allowance in X and Z – (only for ▽ and ▽ + ▽▽▽)	mm
UZ	Finishing allowance in Z – (only for UZ, ▽ and ▽ + ▽▽▽)	mm

* Unit of feedrate as programmed before the cycle call

10.2.6 Thread turning (CYCLE99)

Function

The "Longitudinal thread", "Tapered thread" or "Face thread" cycle is used to turn external or internal threads with a constant or variable pitch.

There may be single or multiple threads.

For metric threads (thread pitch P in mm/rev), the cycle assigns a value (calculated on the basis of the thread pitch) to the thread depth H1 parameter. You can change this value.

The default must be activated via setting data SD 55212
\$SCS_FUNCTION_MASK_Tech_SET.



Machine manufacturer

Please refer to the machine manufacturer's specifications.

The cycle requires a speed-controlled spindle with a position measuring system.

Interruption of thread cutting

You have the option to interrupt thread cutting (for example if the cutting tool is broken).

1. Press the <CYCLE STOP> key.
The tool is retracted from the thread and the spindle is stopped.
2. Replace the tool and press the <CYCLE START> key.
The aborted thread cutting is started again with the interrupted cut at the same depth.

Thread re-machining

You have the option of subsequently machining threads. To do this, change into the "JOG" operating mode and carry out a thread synchronization.

Input simple

For simple machining operations, you have the option to reduce the wide variety of parameters to the most important parameters using the "Input" selection field. In this "Input simple" mode, the hidden parameters are allocated a fixed value that cannot be adjusted.



Machine manufacturer

Various defined values can be pre-assigned using setting data.

Please refer to the machine manufacturer's specifications.

If the workpiece programming requires it, you can display and change all of the parameters using "Input complete".

Approach/retraction

1. The tool moves to the starting point calculated internally in the cycle at rapid traverse.
2. Thread with advance:
The tool moves at rapid traverse to the first starting position displaced by the thread advance LW.
Thread with run-in:
The tool moves at rapid traverse to the starting position displaced by the thread run-in LW2.
3. The first cut is made with thread pitch P as far as the thread run-out LR.
4. Thread with advance:
The tool moves at rapid traverse to the return distance VR and then to the next starting position.
Thread with run-in:
The tool moves at rapid traverse to the return distance VR and then back to the starting position.
5. Steps 3 and 4 are repeated until the thread is finished.
6. The tool moves back to the retraction plane at rapid traverse.

Thread machining can be stopped at any time with the "Rapid lift" function. It ensures that the tool does not damage the thread when it is raised.

Start and end of thread

At the start of the thread, a distinction is made between thread lead (parameter LW) and thread run-in (parameter LW2).

If you program a thread lead, the programmed starting point is moved forward by this amount. You use the thread lead if the thread starts outside the material, for example, on the shoulder of a turned part.

If you program a thread run-in, an additional thread block is generated internally in the cycle. The thread block is inserted in front of the actual thread on which the tool is inserted. You require thread run-in if you want to cut a thread on the middle of a shaft.

If you program a thread run-out > 0, an additional thread block is generated at the end of the thread.

Note

Commands DITS and DITE

In CYCLE99, the commands DITS and DITE are not programmed. The setting data SD 42010 \$SC_THREAD_RAMP_DISP[0] and [1] are not changed.

The parameters thread run-in (LW2) and thread run-out (LR) used in the cycles have a purely geometrical meaning. They do not influence the dynamic response of the thread blocks. The parameters result internally in a concatenation of several thread blocks.

Procedure for longitudinal thread, tapered thread, or face thread



1. The part program or ShopTurn program to be processed has been created and you are in the editor.
2. Press the "Turning" softkey.
3. Press the "Thread" softkey.
The "Thread" input window opens.
4. Press the "Longitudinal thread" softkey.
The "Longitudinal Thread" input window opens.
- OR -
Press the "Tapered thread" softkey.
The "Tapered Thread" input window opens.
- OR -
Press the "Face thread" softkey.
The "Face Thread" input window opens.









Parameter "Longitudinal thread" in the "Input complete" mode

G-code program parameters			Parameters, ShopTurn program		
Input		• Complete			
PL	Machining plane		T	Tool name	
			D	Cutting edge number	
			S / V	Spindle speed or constant cutting rate	rpm m/min





Parameter	Description	Unit
Table 	Thread table selection: <ul style="list-style-type: none"> • Without • ISO metric • Whitworth BSW • Whitworth BSP • UNC 	
Selection - (not for table "Without")	Data, table value, e.g. M10, M12, M14, ...	
P 	Select the thread pitch / turns for table "Without" or specify the thread pitch/turns corresponding to the selection in the thread table: <ul style="list-style-type: none"> • Thread pitch in mm/revolution • Thread pitch in inch/revolution • Thread turns per inch • Thread pitch in MODULUS 	mm/rev in/rev turns/" MODULUS

10.2 Rotate

Parameter	Description	Unit
G	<p>Change in thread pitch per revolution - (only for P = mm/rev or in/rev)</p> <p>G = 0: The thread pitch P does not change.</p> <p>G > 0: The thread pitch P increases by the value G per revolution.</p> <p>G < 0: The thread pitch P decreases by the value G per revolution.</p> <p>If the start and end pitch of the thread are known, the pitch change to be programmed can be calculated as follows:</p> $G = \frac{ P_e^2 - P_a^2 }{2 * Z_1} \text{ [mm/rev}^2\text{]}$ <p>The meanings are as follows:</p> <p>P_e: End pitch of thread [mm/rev]</p> <p>P_a: Start pitch of thread [mm/rev]</p> <p>Z₁: Thread length [mm]</p> <p>A larger pitch results in a larger distance between the thread turns on the workpiece.</p>	mm/rev ²
Machining U	<ul style="list-style-type: none"> ∇ (roughing) ∇∇∇ (finishing) ∇ + ∇∇∇ (roughing and finishing) 	
Infeed (only for ∇ and ∇ + ∇∇∇) U	<ul style="list-style-type: none"> Linear: Infeed with constant cutting depth Degressive: Infeed with constant cutting cross-section 	
Thread U	<ul style="list-style-type: none"> Internal thread External thread 	
X0	Reference point X from thread table Ø (abs)	mm
Z0	Reference point Z (abs)	mm
Z1 U	End point of the thread (abs) or thread length (inc) Incremental dimensions: The sign is also evaluated.	mm
Amount of crown U	<p>Allowance to compensate for sag (- only for external thread and G= 0)</p> <ul style="list-style-type: none"> XS Segment height, crowned thread RS Radius crowned thread <p>Positive values: Convex Negative values: Concave</p> <p>Note: the pitch change per revolution "G" must be "0".</p>	mm mm



Parameter	Description	Unit
LW 	Thread advance (inc) The starting point for the thread is the reference point (X0, Z0) brought forward by the thread advance W. The thread advance can be used if you wish to begin the individual cuts slightly earlier in order to also produce a precise start of thread.	mm
or LW2 	Thread run-in (inc) The thread run-in can be used if you cannot approach the thread from the side and instead have to insert the tool into the material (e.g. lubrication groove on a shaft).	mm
or LW2 = LR 	Thread run-in = thread run-out (inc)	mm
LR	Thread run-out (inc) The thread run-out can be used if you wish to retract the tool obliquely at the end of the thread (e.g. lubrication groove on a shaft).	mm
H1	Thread depth from thread table (inc)	mm
DP 	Infeed slope as flank (inc) – (alternative to infeed slope as angle) DP > 0: Infeed along the rear flank DP < 0: Infeed along the front flank	mm
or αP	Infeed slope as angle – (alternative to infeed slope as flank) $\alpha > 0$: Infeed along the rear flank $\alpha < 0$: Infeed along the front flank $\alpha = 0$: Infeed at right angle to cutting direction If you wish to infeed along the flanks, the maximum absolute value of this parameter may be half the flank angle of the tool.	Degrees
  	Infeed along the flank Infeed with alternating flanks (alternative) Instead of infeed along one flank, you can infeed along alternating flanks to avoid always loading the same tool cutting edge. As a consequence you can increase the tool life. $\alpha > 0$: Start at the rear flank $\alpha < 0$: Start at the front flank	
D0	Initial plunge depth – (only for ∇ and $\nabla + \nabla\nabla\nabla$ under "Manual Machine") If you want to rework some threads, input the initial plunge depth D0 (inc.). This is the depth that was reached during a previous machining. By inputting the plunge depth, you avoid unnecessary idle cuts when reworking the threads.	mm
D1 or ND  (only for ∇ and $\nabla + \nabla\nabla\nabla$)	First infeed depth or number of roughing cuts The respective value is displayed when you switch between the number of roughing cuts and the first infeed.	mm
U	Finishing allowance in X and Z – (only for ∇ and $\nabla + \nabla\nabla\nabla$)	mm
NN	Number of noncuts - (only for $\nabla\nabla\nabla$ and $\nabla + \nabla\nabla\nabla$)	
VR	Return distance (inc)	mm











10.2 Rotate

Parameter	Description		Unit
Multiple threads 	No		
	$\alpha 0$	Starting angle offset	Degrees
	Yes		
	N	Number of thread turns The thread turns are distributed evenly across the periphery of the turned part; the 1st thread turn is always located at 0°.	
	DA	Thread changeover depth (inc) First machine all thread turns sequentially to thread changeover depth DA, then machine all thread turns sequentially to depth 2 · DA, etc. until the final depth is reached. DA = 0: Thread changeover depth is not taken into account, i.e. finish machining each thread before starting the next thread.	mm
Machining: 	<ul style="list-style-type: none"> Complete, or From turn N1 N1 (1...4) start thread N1 = 1...N  or Only thread NX NX (1...4) 1 from N threads  		

Parameter "Longitudinal thread" in the "Input simple" mode

G code program parameters			ShopTurn program parameters		
Input	<ul style="list-style-type: none"> simple 				
			T	Tool name	
			D	Cutting edge number	
			S / V 	Spindle speed or constant cutting rate	rpm m/min

Parameter	Description	Unit
P 	Select the thread pitch / turns for table "Without" or specify the thread pitch/turns corresponding to the selection in the thread table: <ul style="list-style-type: none"> Thread pitch in mm/revolution Thread pitch in inch/revolution Thread turns per inch Thread pitch in MODULUS 	mm/rev in/rev turns/" MODULUS
Machining 	<ul style="list-style-type: none"> ∇ (roughing) ∇∇∇ (finishing) ∇ + ∇∇∇ (roughing and finishing) 	
Infeed (only for ∇ and ∇ + ∇∇∇) 	<ul style="list-style-type: none"> Linear: Infeed with constant cutting depth Degressive: Infeed with constant cutting cross-section 	

Parameter	Description	Unit
Thread 	<ul style="list-style-type: none"> Internal thread External thread 	
X0	Reference point X from thread table \emptyset (abs)	mm
Z0	Reference point Z (abs)	mm
Z1 	End point of the thread (abs) or thread length (inc) Incremental dimensions: The sign is also evaluated.	mm
LW 	Thread advance (inc) The starting point for the thread is the reference point (X0, Z0) brought forward by the thread advance W. The thread advance can be used if you wish to begin the individual cuts slightly earlier in order to also produce a precise start of thread.	mm
or LW2 	Thread run-in (inc) The thread run-in can be used if you cannot approach the thread from the side and instead have to insert the tool into the material (e.g. lubrication groove on a shaft). Thread run-in = thread run-out (inc)	mm
or LW2 = LR 		mm
LR	Thread run-out (inc) The thread run-out can be used if you wish to retract the tool obliquely at the end of the thread (e.g. lubrication groove on a shaft).	mm
H1	Thread depth from thread table (inc)	mm
DP 	Infeed slope as flank (inc) – (alternative to infeed slope as angle) DP > 0: Infeed along the rear flank DP < 0: Infeed along the front flank	mm
or αP	Infeed slope as angle – (alternative to infeed slope as flank) $\alpha > 0$: Infeed along the rear flank $\alpha < 0$: Infeed along the front flank $\alpha = 0$: Infeed at right angle to cutting direction If you wish to infeed along the flanks, the maximum absolute value of this parameter may be half the flank angle of the tool.	Degrees
  	Infeed along the flank Infeed with alternating flanks (alternative) Instead of infeed along one flank, you can infeed along alternating flanks to avoid always loading the same tool cutting edge. As a consequence you can increase the tool life. $\alpha > 0$: Start at the rear flank $\alpha < 0$: Start at the front flank	
D1 or ND  (only for ∇ and $\nabla + \nabla\nabla\nabla$)	First infeed depth or number of roughing cuts The respective value is displayed when you switch between the number of roughing cuts and the first infeed.	mm
U	Finishing allowance in X and Z – (only for ∇ and $\nabla + \nabla\nabla\nabla$)	mm
NN	Number of noncuts - (only for $\nabla\nabla\nabla$ and $\nabla + \nabla\nabla\nabla$)	

10.2 Rotate

Hidden parameters

The following parameters are hidden. They are pre-assigned fixed values or values that can be adjusted using setting data.

Parameter	Description	Value	Can be set in SD
PL	Machining plane	Defined in MD 52005	
Table	Thread table selection	without	
G	Change in thread pitch per revolution – (only for P = mm/rev or in/rev): Without change in thread pitch	0	
XS	Segment height, crowned thread	0 mm	
RS	Radius crowned thread	0 mm	
			
D0	Initial plunge depth for reworking the threads	0 mm	
VR	Return distance	2 mm	x
Multiple threads	1 thread	No	
α0	Starting angle offset	0°	









Machine manufacturer









Please refer to the machine manufacturer's specifications.





Parameter "Tapered thread" in the "Input complete" mode

G-code program parameters			Parameters, ShopTurn program		
Input		• Complete			
PL	Machining plane		T	Tool name	
			D	Cutting edge number	
			S / V	Spindle speed or constant cutting rate	rpm m/min
					

Parameter	Description	Unit
P 	<ul style="list-style-type: none"> • Thread pitch in mm/revolution • Thread pitch in inch/revolution • Thread turns per inch • Thread pitch in MODULUS 	mm/rev in/rev turns/" MODULUS
G	<p>Change in thread pitch per revolution - (only for P = mm/rev or in/rev)</p> <p>G = 0: The thread pitch P does not change. G > 0: The thread pitch P increases by the value G per revolution. G < 0: The thread pitch P decreases by the value G per revolution.</p> <p>If the start and end pitch of the thread are known, the pitch change to be programmed can be calculated as follows:</p> $G = \frac{ P_e^2 - P^2 }{2 * Z_1} \text{ [mm/rev}^2\text{]}$ <p>The meanings are as follows: P_e: End pitch of thread [mm/rev] P: Start pitch of thread [mm/rev] Z₁: Thread length [mm]</p> <p>A larger pitch results in a larger distance between the thread turns on the workpiece.</p>	mm/rev ²
Machining 	<ul style="list-style-type: none"> • ∇ (roughing) • ∇∇∇ (finishing) • ∇ + ∇∇∇ (roughing and finishing) 	
Infeed (only for ∇ and ∇ + ∇∇∇) 	<ul style="list-style-type: none"> • Linear: Infeed with constant cutting depth • Degressive: Infeed with constant cutting cross-section 	
Thread 	<ul style="list-style-type: none"> • Internal thread • External thread 	
X0	Reference point X ∅ (abs, always diameter)	mm
Z0	Reference point Z (abs)	mm
X1 or X1α 	<p>End point X ∅ (abs) or end point in relation to X0 (inc) or Thread taper</p> <p>Incremental dimensions: The sign is also evaluated.</p>	mm or degrees
Z1 	<p>End point Z (abs) or end point in relation to Z0 (inc)</p> <p>Incremental dimensions: The sign is also evaluated.</p>	mm



10.2 Rotate

Parameter	Description	Unit
LW 	Thread advance (inc) The starting point for the thread is the reference point (X0, Z0) brought forward by the thread advance W. The thread advance can be used if you wish to begin the individual cuts slightly earlier in order to also produce a precise start of thread.	mm
or LW2 	Thread run-in (inc) The thread run-in can be used if you cannot approach the thread from the side and instead have to insert the tool into the material (e.g. lubrication groove on a shaft). Thread run-in = thread run-out (inc)	mm
or LW2 = LR 		mm
LR	Thread run-out (inc) The thread run-out can be used if you wish to retract the tool obliquely at the end of the thread (e.g. lubrication groove on a shaft).	mm
H1	Thread depth (inc)	mm
DP 	Infeed slope as flank (inc) – (alternative to infeed slope as angle) DP > 0: Infeed along the rear flank DP < 0: Infeed along the front flank	mm
or α P	Infeed slope as angle – (alternative to infeed slope as flank) α > 0: Infeed along the rear flank α < 0: Infeed along the front flank α = 0: Infeed at right angle to cutting direction If you wish to infeed along the flanks, the maximum absolute value of this parameter may be half the flank angle of the tool.	Degrees
  	Infeed along the flank Infeed with alternating flanks (alternative) Instead of infeed along one flank, you can infeed along alternating flanks to avoid always loading the same tool cutting edge. As a consequence you can increase the tool life. α > 0: Start at the rear flank α < 0: Start at the front flank	
D0	Initial plunge depth – (only for ∇ and $\nabla + \nabla\nabla\nabla$ under "Manual Machine") If you want to rework some threads, input the initial plunge depth D0 (inc.). This is the depth that was reached during a previous machining. By inputting the plunge depth, you avoid unnecessary idle cuts when reworking the threads.	mm
D1 or ND  (only for ∇ and $\nabla + \nabla\nabla\nabla$)	First infeed depth or number of roughing cuts The respective value is displayed when you switch between the number of roughing cuts and the first infeed.	mm
U	Finishing allowance in X and Z – (only for ∇ and $\nabla + \nabla\nabla\nabla$)	mm
NN	Number of noncuts - (only for $\nabla\nabla\nabla$ and $\nabla + \nabla\nabla\nabla$)	
VR	Return distance (inc)	mm









Parameter	Description	Unit	
Multiple threads 	No		
	$\alpha 0$	Starting angle offset	Degrees
	Yes		
	N	Number of thread turns The thread turns are distributed evenly across the periphery of the turned part; the 1st thread turn is always located at 0°.	
	DA	Thread changeover depth (inc) First machine all thread turns sequentially to thread changeover depth DA, then machine all thread turns sequentially to depth 2 · DA, etc. until the final depth is reached. DA = 0: Thread changeover depth is not taken into account, i.e. finish machining each thread before starting the next thread.	mm
Machining: 	<ul style="list-style-type: none"> • Complete, or • from turn N1 N1 (1...4) start thread N1 = 1...N  or • only thread NX NX (1...4) 1 from N threads  		

Parameter "Tapered thread" in the "Input simple" mode

G code program parameters		ShopTurn program parameters		
Input	• simple			
		T	Tool name	
		D	Cutting edge number	
		S / V 	Spindle speed or constant cutting rate	rpm m/min

Parameter	Description	Unit
P 	Select the thread pitch / turns for table "without" or specify the thread pitch/turns corresponding to the selection in the thread table: <ul style="list-style-type: none"> • Thread pitch in mm/revolution • Thread pitch in inch/revolution • Thread turns per inch • Thread pitch in MODULUS 	mm/rev in/rev turns/" MODULUS
Machining 	<ul style="list-style-type: none"> • ∇ (roughing) • ∇∇∇ (finishing) • ∇ + ∇∇∇ (roughing and finishing) 	
Infeed (only for ∇ and ∇ + ∇∇∇) 	<ul style="list-style-type: none"> • Linear: Infeed with constant cutting depth • Degressive: Infeed with constant cutting cross-section 	

10.2 Rotate

Parameter	Description	Unit
Thread 	<ul style="list-style-type: none"> • Internal thread • External thread 	
X0	Reference point X Ø (abs, always diameter)	mm
Z0	Reference point Z (abs)	mm
X1 or X1α 	End point X Ø (abs) or end point in relation to X0 (inc) or thread taper incremental dimensions: The sign is also evaluated.	mm or degrees
Z1 	End point Z (abs) or end point in relation to Z0 (inc) Incremental dimensions: The sign is also evaluated.	mm
LW 	Thread advance (inc) The starting point for the thread is the reference point (X0, Z0) brought forward by the thread advance W. The thread advance can be used if you wish to begin the individual cuts slightly earlier in order to also produce a precise start of thread.	mm
or LW2 	Thread run-in (inc) The thread run-in can be used if you cannot approach the thread from the side and instead have to insert the tool into the material (e.g. lubrication groove on a shaft). Thread run-in = thread run-out (inc)	mm
or LW2 = LR 		mm
LR	Thread run-out (inc) The thread run-out can be used if you wish to retract the tool obliquely at the end of the thread (e.g. lubrication groove on a shaft).	mm
H1	Thread depth (inc)	mm
DP 	Infeed slope as flank (inc) – (alternative to infeed slope as angle) DP > 0: Infeed along the rear flank DP < 0: Infeed along the front flank	mm
or αP	Infeed slope as angle – (alternative to infeed slope as flank) α > 0: Infeed along the rear flank α < 0: Infeed along the front flank α = 0: Infeed at right angle to cutting direction If you wish to infeed along the flanks, the maximum absolute value of this parameter may be half the flank angle of the tool.	Degrees
	Infeed along the flank Infeed with alternating flanks (alternative) Instead of infeed along one flank, you can infeed along alternating flanks to avoid always loading the same tool cutting edge. As a consequence you can increase the tool life. α > 0: Start at the rear flank α < 0: Start at the front flank	
D1 or ND  (only for ▽ and ▽ + ▽▽▽)	First infeed depth or number of roughing cuts The respective value is displayed when you switch between the number of roughing cuts and the first infeed.	mm
U	Finishing allowance in X and Z – (only for ▽ and ▽ + ▽▽▽)	mm
NN	Number of noncuts - (only for ▽▽▽ and ▽ + ▽▽▽)	

Hidden parameters

The following parameters are hidden. They are pre-assigned fixed values or values that can be adjusted using setting data.

Parameter	Description	Value	Can be set in SD
PL	Machining plane	Defined in MD 52005	
G	Change in thread pitch per revolution – (only for P = mm/rev or in/rev): Without change in thread pitch	0	
D0	Initial plunge depth for reworking the threads	0 mm	
VR	Return distance	2 mm	x
Multiple threads	1 thread	No	
α0	Starting angle offset	0°	











Machine manufacturer



Please refer to the machine manufacturer's specifications.

Parameter "Face thread" in the "Input complete" mode





G-code program parameters			Parameters, ShopTurn program		
Input		• Complete			
PL	Machining plane		T	Tool name	
			D	Cutting edge number	
			S / V	Spindle speed or constant cutting rate	rpm m/min
					

10.2 Rotate

Parameter	Description	Unit
P 	<ul style="list-style-type: none"> • Thread pitch in mm/revolution • Thread pitch in inch/revolution • Thread turns per inch • Thread pitch in MODULUS 	mm/rev in/rev turns/" MODULUS
G	<p>Change in thread pitch per revolution - (only for P = mm/rev or in/rev)</p> <p>G = 0: The thread pitch P does not change. G > 0: The thread pitch P increases by the value G per revolution. G < 0: The thread pitch P decreases by the value G per revolution.</p> <p>If the start and end pitch of the thread are known, the pitch change to be programmed can be calculated as follows:</p> $G = \frac{ P_e^2 - P^2 }{2 * Z_1} \text{ [mm/rev}^2\text{]}$ <p>The meanings are as follows: P_e: End pitch of thread [mm/rev] P: Start pitch of thread [mm/rev] Z₁: Thread length [mm]</p> <p>A larger pitch results in a larger distance between the thread turns on the workpiece.</p>	mm/rev ²
Machining 	<ul style="list-style-type: none"> • ∇ (roughing) • ∇∇∇ (finishing) • ∇ + ∇∇∇ (roughing and finishing) 	
Infeed (only for ∇ and ∇ + ∇∇∇) 	<ul style="list-style-type: none"> • Linear: Infeed with constant cutting depth • Degressive: Infeed with constant cutting cross-section 	
Thread 	<ul style="list-style-type: none"> • Internal thread • External thread 	
X0	Reference point X Ø (abs, always diameter)	mm
Z0	Reference point Z (abs)	mm
X1 	End point of the thread Ø (abs) or thread length (inc) Incremental dimensions: The sign is also evaluated.	mm
LW  or LW2  or LW2 = LR 	<p>Thread advance (inc)</p> <p>The starting point for the thread is the reference point (X0, Z0) brought forward by the thread advance W. The thread advance can be used if you wish to begin the individual cuts slightly earlier in order to also produce a precise start of thread.</p> <p>Thread run-in (inc)</p> <p>The thread run-in can be used if you cannot approach the thread from the side and instead have to insert the tool into the material (e.g. lubrication groove on a shaft).</p> <p>Thread run-in = thread run-out (inc)</p>	mm mm mm



Parameter	Description	Unit
LR	Thread run-out (inc) The thread run-out can be used if you wish to retract the tool obliquely at the end of the thread (e.g. lubrication groove on a shaft).	mm
H1	Thread depth (inc)	mm
DP 	Infeed slope as flank (inc) – (alternative to infeed slope as angle) DP > 0: Infeed along the rear flank DP < 0: Infeed along the front flank	
or αP	Infeed slope as angle – (alternative to infeed slope as flank) $\alpha > 0$: Infeed along the rear flank $\alpha < 0$: Infeed along the front flank $\alpha = 0$: Infeed at right angle to cutting direction If you wish to infeed along the flanks, the maximum absolute value of this parameter may be half the flank angle of the tool.	Degrees
	Infeed along the flank Infeed with alternating flanks (alternative) Instead of infeed along one flank, you can infeed along alternating flanks to avoid always loading the same tool cutting edge. As a consequence you can increase the tool life. $\alpha > 0$: Start at the rear flank $\alpha < 0$: Start at the front flank	
D0	Initial plunge depth – (only for ∇ and $\nabla + \nabla\nabla\nabla$ under "Manual Machine") If you want to rework some threads, input the initial plunge depth D0 (inc.). This is the depth that was reached during a previous machining. By inputting the plunge depth, you avoid unnecessary idle cuts when reworking the threads.	mm
D1 or ND  (only for ∇ and $\nabla + \nabla\nabla\nabla$)	First infeed depth or number of roughing cuts The respective value is displayed when you switch between the number of roughing cuts and the first infeed.	mm
U	Finishing allowance in X and Z – (only for ∇ and $\nabla + \nabla\nabla\nabla$)	mm
NN	Number of noncuts - (only for $\nabla\nabla\nabla$ and $\nabla + \nabla\nabla\nabla$)	
VR	Return distance (inc)	mm









10.2 Rotate

Parameter	Description	Unit	
Multiple threads 	No		
	$\alpha 0$	Starting angle offset	Degrees
	Yes		
	N	Number of thread turns The thread turns are distributed evenly across the periphery of the turned part; the 1st thread turn is always located at 0°.	
	DA	Thread changeover depth (inc) First machine all thread turns sequentially to thread changeover depth DA, then machine all thread turns sequentially to depth 2 · DA, etc. until the final depth is reached. DA = 0: Thread changeover depth is not taken into account, i.e. finish machining each thread before starting the next thread.	mm
Machining: 	<ul style="list-style-type: none"> • Complete, or • From turn N1 N1 (1...4) start thread N1 = 1...N  or • Only thread NX NX (1...4) 1 from N threads  		

Parameter "Face thread" in the "Input simple" mode

G code program parameters			ShopTurn program parameters		
Input	• simple				
			T	Tool name	
			D	Cutting edge number	
			S / V 	Spindle speed or constant cutting rate	rpm m/min

Parameter	Description	Unit
P 	Select the thread pitch / turns for table "Without" or specify the thread pitch/turns corresponding to the selection in the thread table: <ul style="list-style-type: none"> • Thread pitch in mm/revolution • Thread pitch in inch/revolution • Thread turns per inch • Thread pitch in MODULUS 	mm/rev in/rev turns/" MODULUS
Machining 	<ul style="list-style-type: none"> • ∇ (roughing) • ∇∇∇ (finishing) • ∇ + ∇∇∇ (roughing and finishing) 	
Infeed (only for ∇ and ∇ + ∇∇∇) 	<ul style="list-style-type: none"> • Linear: Infeed with constant cutting depth • Degressive: Infeed with constant cutting cross-section 	

Parameter	Description	Unit
Thread 	<ul style="list-style-type: none"> Internal thread External thread 	
X0	Reference point X \varnothing (abs, always diameter)	mm
Z0	Reference point Z (abs)	mm
X1 	End point of the thread (abs) or thread length (inc) Incremental dimensions: The sign is also evaluated.	mm
LW 	Thread advance (inc) The starting point for the thread is the reference point (X0, Z0) brought forward by the thread advance W. The thread advance can be used if you wish to begin the individual cuts slightly earlier in order to also produce a precise start of thread.	mm
or LW2 	Thread run-in (inc) The thread run-in can be used if you cannot approach the thread from the side and instead have to insert the tool into the material (e.g. lubrication groove on a shaft). Thread run-in = thread run-out (inc)	mm
or LW2 = LR 		mm
LR	Thread run-out (inc) The thread run-out can be used if you wish to retract the tool obliquely at the end of the thread (e.g. lubrication groove on a shaft).	mm
H1	Thread depth from thread table (inc)	mm
DP 	Infeed slope as flank (inc) – (alternative to infeed slope as angle) DP > 0: Infeed along the rear flank DP < 0: Infeed along the front flank	mm
or α P	Infeed slope as angle – (alternative to infeed slope as flank) α > 0: Infeed along the rear flank α < 0: Infeed along the front flank α = 0: Infeed at right angle to cutting direction If you wish to infeed along the flanks, the maximum absolute value of this parameter may be half the flank angle of the tool.	Degrees
	Infeed along the flank Infeed with alternating flanks (alternative) Instead of infeed along one flank, you can infeed along alternating flanks to avoid always loading the same tool cutting edge. As a consequence you can increase the tool life. α > 0: Start at the rear flank α < 0: Start at the front flank	
D1 or ND  (only for ∇ and $\nabla + \nabla\nabla\nabla$)	First infeed depth or number of roughing cuts The respective value is displayed when you switch between the number of roughing cuts and the first infeed.	mm
U	Finishing allowance in X and Z – (only for ∇ and $\nabla + \nabla\nabla\nabla$)	mm
NN	Number of noncuts - (only for $\nabla\nabla\nabla$ and $\nabla + \nabla\nabla\nabla$)	

10.2 Rotate

Hidden parameters

The following parameters are hidden. They are pre-assigned fixed values or values that can be adjusted using setting data.

Parameter	Description	Value	Can be set in SD
PL	Machining plane	Defined in MD 52005	
G	Change in thread pitch per revolution – (only for P = mm/rev or in/rev): Without change in thread pitch	0	
D0	Initial plunge depth for reworking the threads	0 mm	
VR	Return distance	2 mm	x
Multiple threads	1 Thread	No	
$\alpha 0$	Starting angle offset	0°	



Machine manufacturer

Please refer to the machine manufacturer's specifications.

10.2.7 Thread chain (CYCLE98)

Function

With this cycle, you can produce several concatenated cylindrical or tapered threads with a constant pitch in longitudinal and face machining, all of which can have different thread pitches.

There may be single or multiple threads. With multiple threads, the individual thread turns are machined one after the other.

You define a right or left-hand thread by the direction of spindle rotation and the feed direction.

The infeed is performed automatically with a constant infeed depth or constant cutting cross-section.

- With a constant infeed depth, the cutting cross-section increases from cut to cut. The finishing allowance is machined in one cut after roughing.
A constant infeed depth can produce better cutting conditions at small thread depths.
- With a constant cutting cross-section, the cutting pressure remains constant over all roughing cuts and the infeed depth is reduced.

The feedrate override has no effect during traversing blocks with thread. The spindle override must not be changed during the thread machining.

Interruption of thread cutting

You have the option to interrupt thread cutting (for example if the cutting tool is broken).

1. Press the <CYCLE STOP> key.
The tool is retracted from the thread and the spindle is stopped.
2. Replace the tool and press the <CYCLE START> key.
The aborted thread cutting is started again with the interrupted cut at the same depth.

Input simple

For simple machining operations, you have the option to reduce the wide variety of parameters to the most important parameters using the "Input" selection field. In this "Input simple" mode, the hidden parameters are allocated a fixed value that cannot be adjusted.



Machine manufacturer

Various defined values can be pre-assigned using setting data.
Please refer to the machine manufacturer's specifications.

If the workpiece programming requires it, you can display and change all of the parameters using "Input complete".

Approach/retraction

1. Approach of the starting point determined in the cycle at the beginning of the run-in path for the first thread with G0
2. Infeed for roughing according to the defined infeed type.
3. Thread cutting is repeated according to the programmed number of roughing cuts.
4. The finishing allowance is removed in the following step with G33.
5. This cut is repeated according to the number of noncuts.
6. The whole sequence of motions is repeated for each further thread.

Start and end of thread

At the start of the thread, a distinction is made between thread lead (parameter LW) and thread run-in (parameter LW2).

If you program a thread lead, the programmed starting point is moved forward by this amount. You use the thread lead if the thread starts outside the material, for example, on the shoulder of a turned part.

If you program a thread run-in, an additional thread block is generated internally in the cycle. The thread block is inserted in front of the actual thread on which the tool is inserted. You require thread run-in if you want to cut a thread on the middle of a shaft.

10.2 Rotate

If you program a thread run-out > 0, an additional thread block is generated at the end of the thread.

Note

Commands DITS and DITE

In CYCLE99, the commands DITS and DITE are not programmed. The setting data SD 42010 \$SC_THREAD_RAMP_DISP[0] and [1] are not changed.

The parameters thread run-in (LW2) and thread run-out (LR) used in the cycles have a purely geometrical meaning. They do not influence the dynamic response of the thread blocks. The parameters result internally in a concatenation of several thread blocks.

Procedure for thread chain















1. The part program or ShopTurn program to be processed has been created and you are in the editor.
2. Press the "Turning" softkey.
3. Press the "Thread" softkey.
The "Thread" input window opens.
4. Press the "Thread chain" softkey.
The "Thread Chain" input window opens.

Parameters in the "Input complete" mode

G code program parameters			ShopTurn program parameters		
Input		• Complete			
PL	Machining plane		T	Tool name	
SC	Safety clearance	mm	D	Cutting edge number	
			S / V	Spindle speed or constant cutting rate	rpm m/min

Parameter	Description	Unit
Machining 	<ul style="list-style-type: none"> • ∇ (roughing) • ∇∇∇ (finishing) • ∇ + ∇∇∇ (roughing and finishing) 	
Infeed (only for ∇ and ∇ + ∇∇∇) 	<ul style="list-style-type: none"> • Linear: Constant cutting depth infeed • Degressive: Constant cutting cross-section infeed 	
Thread 	<ul style="list-style-type: none"> • Internal thread • External thread 	







Parameter	Description	Unit
X0	Reference point X \varnothing (abs, always diameter)	mm
Z0	Reference point Z (abs)	mm
P0 	Thread pitch 1	mm/rev in/rev turns/" MODULUS
X1 or X1 α 	<ul style="list-style-type: none"> Intermediate point 1 X \varnothing (abs) or Intermediate point 1 in relation to X0 (inc) or Thread taper 1 Incremental dimensions: The sign is also evaluated.	mm Degrees
Z1 	<ul style="list-style-type: none"> Intermediate point 1 Z (abs) or Intermediate point 1 in relation to Z0 (inc) 	mm
P1	Thread pitch 2 (unit as parameterized for P0)	mm/rev in/rev turns/" MODULUS
X2 or X2 α 	<ul style="list-style-type: none"> Intermediate point 2 X \varnothing (abs) or Intermediate point 2 in relation to X1 (inc) or Thread taper 2 Incremental dimensions: The sign is also evaluated.	mm Degrees
Z2 	<ul style="list-style-type: none"> Intermediate point 2 Z (abs) or Intermediate point 2 in relation to Z1 (inc) 	mm
P2	Thread pitch 3 (unit as parameterized for P0)	mm/rev in/rev turns/" MODULUS
X3 	<ul style="list-style-type: none"> End point X \varnothing (abs) or End point 3 in relation to X2 (inc) or Thread taper 3 	mm Degrees
Z3 	<ul style="list-style-type: none"> End point Z \varnothing (abs) or End point with reference to Z2 (inc) 	mm
LW	Thread run-in	mm
LR	Thread run-out	mm
H1	Thread depth	mm
DP or α P 	Infeed slope (flank) or infeed slope (angle)	mm or de- grees
  	<ul style="list-style-type: none"> Infeed along a flank Infeed with alternating flanks 	
D1 or ND 	First infeed depth or number of roughing cuts - (only for ∇ and $\nabla + \nabla\nabla\nabla$)	mm
U	Finishing allowance in X and Z - (only for ∇ and $\nabla + \nabla\nabla\nabla$)	mm
NN	Number of noncuts - (only for $\nabla\nabla\nabla$ and $\nabla + \nabla\nabla\nabla$)	











10.2 Rotate

Parameter	Description	Unit	
VR	Return distance	mm	
Multiple threads 	No		
	$\alpha 0$	Starting angle offset	Degrees
	Yes		
	N	Number of thread turns	
	DA	Thread changeover depth (inc)	mm

Parameters in the "Input simple" mode

G code program parameters			ShopTurn program parameters		
Input	• simple				
			T	Tool name	
			D	Cutting edge number	
			S / V 	Spindle speed or constant cutting rate	rpm m/min

Parameter	Description	Unit
Machining 	<ul style="list-style-type: none"> ∇ (roughing) ∇∇∇ (finishing) ∇ + ∇∇∇ (roughing and finishing) 	
Infeed (only for ∇ and ∇ + ∇∇∇) 	<ul style="list-style-type: none"> Linear: Infeed with constant cutting depth Degressive: Infeed with constant cutting cross-section 	
Thread 	<ul style="list-style-type: none"> Internal thread External thread 	
X0	Reference point X Ø (abs, always diameter)	mm
Z0	Reference point Z (abs)	mm
P0 	Thread pitch 1	mm/rev in/rev turns/" MODULUS
X1 or X1α 	<ul style="list-style-type: none"> Intermediate point 1 X Ø (abs) or Intermediate point 1 in relation to X0 (inc) or Thread taper 1 Incremental dimensions: The sign is also evaluated	mm Degrees
Z1 	<ul style="list-style-type: none"> Intermediate point 1 Z (abs) or Intermediate point 1 in relation to Z0 (inc) 	mm

Parameter	Description	Unit
P1 	Thread pitch 2 (unit as parameterized for P0)	mm/rev in/rev turns/" MODULUS
X2 or X2α 	<ul style="list-style-type: none"> Intermediate point 2 X Ø (abs) or Intermediate point 2 in relation to X1 (inc) or Thread taper 2 Incremental dimensions: The sign is also evaluated	mm Degrees
Z2 	<ul style="list-style-type: none"> Intermediate point 2 Z (abs) or Intermediate point 2 in relation to Z1 (inc) 	mm
P2 	Thread pitch 3 (unit as parameterized for P0)	mm/rev in/rev turns/" MODULUS
X3 	<ul style="list-style-type: none"> End point X Ø (abs) or End point 3 in relation to X2 (inc) or Thread taper 3 	mm Degrees
Z3 	<ul style="list-style-type: none"> End point Z Ø (abs) or End point with reference to Z2 (inc) 	mm
LW	Thread advance (inc)	mm
LR	Thread run-out (inc)	mm
H1	Thread depth (inc)	mm
DP or αP 	Infeed slope (flank) or infeed slope (angle)	mm or degrees
  	Infeed along the flank Infeed with alternating flanks	
D1 or ND 	First infeed depth or number of roughing cuts (only for ▽ and ▽ + ▽▽▽)	mm
U	Finishing allowance in X and Z – (only for ▽ and ▽ + ▽▽▽)	mm
NN	Number of noncuts - (only for ▽▽▽ and ▽ + ▽▽▽)	

Hidden parameters

The following parameters are hidden. They are pre-assigned fixed values or values that can be adjusted using setting data.

Parameter	Description	Value	Can be set in SD
PL	Machining plane	Defined in MD 52005	
VR	Return distance	2 mm	x
Multiple threads	1 Thread	No	
α0	Starting angle offset	0°	



Machine manufacturer

Please refer to the machine manufacturer's specifications.

10.2.8 Cut-off (CYCLE92)

Function

The "Cut-off" cycle is used when you want to cut off dynamically balanced parts (e.g. screws, bolts, or pipes).

You can program a chamfer or rounding on the edge of the machined part. You can machine at a constant cutting rate V or speed S up to a depth X1, from which point the workpiece is machined at a constant speed. As of depth X1, you can also program a reduced feedrate FR or a reduced speed SR, in order to adapt the velocity to the smaller diameter.

Use parameter X2 to enter the final depth that you wish to reach with the cut-off. With pipes, for example, you do not need to cut-off until you reach the center; cutting off slightly more than the wall thickness of the pipe is sufficient.

Approach/retraction

1. The tool first moves to the starting point calculated internally in the cycle at rapid traverse.
2. The chamfer or radius is machined at the machining feedrate.
3. Cut-off down to depth X1 is performed at the machining feedrate.
4. Cut-off is continued down to depth X2 at reduced feedrate FR and reduced speed SR.
5. The tool moves back to the safety distance at rapid traverse.

If your turning machine is appropriately set up, you can extend a workpiece drawer (part catcher) to accept the cut-off workpiece. Extension of the workpiece drawer must be enabled in a machine data element.



Machine manufacturer

Please refer to the machine manufacturer's specifications.

Procedure



1. The part program or ShopTurn program to be processed has been created and you are in the editor.
2. Press the "Turning" softkey.
3. Press the "Cut-off" softkey.
The "Cut-off" input window opens.

Parameters, G code program			Parameters, ShopTurn program		
PL	Machining plane		T	Tool name	
SC	Safety clearance	mm	D	Cutting edge number	
F	Feedrate	*	F	Feedrate	mm/rev
			S / V	Spindle speed or constant cutting rate	rpm m/min

Parameter	Description	Unit
DIR (only for G code)	Direction of spindle rotation 	
S	Spindle speed	rev/min
V	Constant cutting rate	m/min
SV	Maximum speed limit - (only for constant cutting rate V)	rev/min
X0	Reference point in X \varnothing (abs, always diameter)	mm
Z0	Reference point in Z (abs)	mm
FS or R	Chamfer width or rounding radius	mm
X1	Depth for speed reduction \varnothing (abs) or depth for speed reduction in relation to X0 (inc)	mm
FR (only for ShopTurn)	Reduced feedrate	mm/rev
FR (only for G code)		*
SR	Reduced speed	rev/min
X2	Final depth \varnothing (abs) or final depth in relation to X1 (inc)	mm

* Unit of feedrate as programmed before the cycle call

10.3 Contour turning

10.3.1 General information

Function

You can machine simple or complex contours with the "Contour turning" cycle. A contour comprises separate contour elements, whereby at least two and up to 250 elements result in a defined contour.

You can program chamfers, radii, undercuts or tangential transitions between the contour elements.

The integrated contour calculator calculates the intersection points of the individual contour elements taking into account the geometrical relationships, which allows you to enter incompletely dimensioned elements.

When you machine the contour, you can make allowance for a blank contour, which must be entered before the finished-part contour. Then select one of the the following machining technologies:

- Stock removal
- Grooving
- Plunge-turning

You can rough, remove residual material and finish for each of the three technologies above.

Note

Starting point or end point of the machining outside the retraction planes

For programs with contour machining from earlier software releases, for an NC start, it is possible that one of the alarms 61281 "Starting point of machining outside retraction planes" or 61282 "End point of machining outside retraction planes" is output.

In this case, adapt the retraction planes in the program header.

Programming

For example, the programming procedure for stock removal is as follows:

Note

When programming in G code, it must be ensured that the contours are located after the end of program identifier!

1. Enter the blank contour
If, when removing stock along the contour, you want to take into account a blank contour (and no cylinder or no allowance) as blank shape, then you must define the contour of the blank before you define the finished-part contour. Compile the blank contour step-by-step from various contour elements.
2. Enter finished-part contour
You build up the finished-part contour gradually from a series of different contour elements.
3. Contour call - only for G code program
4. Stock removal along the contour (roughing)
The contour is machined longitudinally, transversely or parallel to the contour.
5. Remove residual material (roughing)
When removing stock along the contour, ShopTurn automatically detects residual material that has been left. For G code programming, when removing stock, it must first be decided whether to machine with residual material detection - or not. A suitable tool will allow you to remove this without having to machine the contour again.
6. Stock removal along the contour (finishing)
If you programmed a finishing allowance for roughing, the contour is machined again.

10.3.2 Representation of the contour

G code program





In the editor, the contour is represented in a program section using individual program blocks. If you open an individual block, then the contour is opened.

ShopTurn program





The cycle represents a contour as a program block in the program. If you open this block, the individual contour elements are listed symbolically and displayed in broken-line graphics.

Symbolic representation

The individual contour elements are represented by symbols adjacent to the graphics window. They appear in the order in which they were entered.

Contour element	Symbol	Meaning
Starting point		Starting point of the contour
Straight line up		Straight line in 90° grid
Straight line down		Straight line in 90° grid
Straight line left		Straight line in 90° grid
Straight line right		Straight line in 90° grid

10.3 Contour turning

Contour element	Symbol	Meaning
Straight line in any direction		Straight line with any gradient
Arc right		Circle
Arc left		Circle
Pole		Straight diagonal or circle in polar coordinates
Finish contour	END	End of contour definition

The different colors of the symbols indicate their status:

Foreground	Background	Meaning
Black	Blue	Cursor on active element
Black	Orange	Cursor on current element
Black	White	Normal element
Red	White	Element not currently evaluated (element will only be evaluated when it is selected with the cursor)

Graphic display

The progress of contour programming is shown in broken-line graphics while the contour elements are being entered.

When the contour element has been created, it can be displayed in different line styles and colors:

- Black: Programmed contour
- Orange: Current contour element
- Green dashed: Alternative element
- Blue dotted: Partially defined element

The scaling of the coordinate system is adjusted automatically to match the complete contour.

The position of the coordinate system is displayed in the graphics window.

10.3.3 Creating a new contour

Function

For each contour that you want to cut, you must create a new contour.

The first step in creating a contour is to specify a starting point. Enter the contour element. The contour processor then automatically defines the end of the contour.





Procedure



1. The part program or ShopTurn program to be processed has been created and you are in the editor.
2. Press the "Contour turning" softkey.
3. Press the "Contour" and "New contour" softkeys. The "New Contour" input window opens.
4. Enter a name for the new contour. The contour name must be unique.
5. Press the "Accept" softkey. The input window for the starting point of the contour appears. Enter the individual contour elements (see Section "Creating contour elements").

Parameter	Description	Unit
Z	Starting point Z (abs)	mm
X	Starting point X Ø (abs)	mm
Transition to contour start 	Type of transition <ul style="list-style-type: none"> • Radius • Chamfer FS=0 or R=0: No transition element	
R	Transition to following element – radius	mm
FS	Transition to following element – chamfer	mm

10.3 Contour turning

Parameter	Description	Unit
Direction in front of the contour 	<p>Direction of the contour element towards the starting point:</p> <ul style="list-style-type: none">  <ul style="list-style-type: none"> In the negative direction of the horizontal axis  <ul style="list-style-type: none"> In the positive direction of the horizontal axis  <ul style="list-style-type: none"> In the negative direction of the vertical axis  <ul style="list-style-type: none"> In the positive direction of the vertical axis 	
Additional commands	<p>You can enter additional commands in the form of G code for each contour element. You can enter the additional commands (max. 40 characters) in the extended parameter screens ("All parameters" softkey). The softkey is always available at the starting point, it only has to be pressed when entering additional contour elements.</p> <p>You can program feedrates and M commands, for example, using additional G code commands. However, carefully ensure that the additional commands do not collide with the generated G code of the contour and are compatible with the machining type required. Therefore, do not use any G code commands of group 1 (G0, G1, G2, G3), no coordinates in the plane and no G code commands that have to be programmed in a separate block.</p> <p>The contour is finished in continuous-path mode (G64). As a result, contour transitions such as corners, chamfers or radii may not be machined precisely.</p> <p>If you wish to avoid this, then it is possible to use additional commands when programming.</p> <p>Example: For a contour, first program the straight X parallel and then enter "G9" (non-modal exact stop) for the additional command parameter. Then program the Z-parallel straight line. The corner will be machined exactly, as the feedrate at the end of the X-parallel straight line is briefly zero.</p> <p>Note: The additional commands are only effective for finishing!</p>	

10.3.4 Creating contour elements

Creating contour elements

After you have created a new contour and specified the starting point, you can define the individual elements that make up the contour.

The following contour elements are available for the definition of a contour:

- Straight vertical line
- Straight horizontal line

- Straight diagonal line
- Circle/arc

For each contour element, you must parameterize a separate parameter screen. Parameter entry is supported by various help screens that explain these parameters.

If you leave certain fields blank, the cycle assumes that the values are unknown and attempts to calculate them from other parameters.

Conflicts may result if you enter more parameters than are absolutely necessary for a contour. In such a case, try entering less parameters and allowing the cycle to calculate as many parameters as possible.

Contour transition elements

As transition element between two contour elements, you can select a radius or a chamfer or, in the case of linear contour elements, an undercut. The transition element is always attached at the end of a contour element. The contour transition element is selected in the parameter screen of the respective contour element.

You can use a contour transition element whenever there is an intersection between two successive elements which can be calculated from the input values. Otherwise you must use the straight/circle contour elements.

Additional commands

You can enter additional commands in the form of G code for each contour element. You can enter the additional commands (max. 40 characters) in the extended parameter screens ("All parameters" softkey).

You can program feedrates and M commands, for example, using additional G-code commands. However, make sure that the additional commands do not collide with the generated G code of the contour. Therefore, do not use any G-code commands of group 1 (G0, G1, G2, G3), no coordinates in the plane and no G-code commands that have to be programmed in a separate block.

Additional functions

The following additional functions are available for programming a contour:

- Tangent to preceding element
You can program the transition to the preceding element as tangent.
- Dialog box selection

If two different possible contours result from the parameters entered thus far, one of the options must be selected.

- Close contour

From the current position, you can close the contour with a straight line to the starting point.

Producing exact contour transitions

The continuous path mode (G64) is used. This means, that contour transitions such as corners, chamfers or radii may not be machined precisely.

If you wish to avoid this, there are two different options when programming. Use the additional programs or program the special feedrate for the transition element.

- Additional command

For a contour, first program the vertical straight line and then enter "G9" (non-modal exact stop) for the additional command parameter. Then program the horizontal straight line. The corner will be machined exactly, since the feedrate at the end of the vertical straight line is briefly zero.

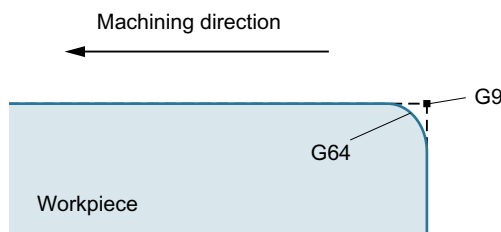

- Feedrate, transition element

If you have chosen a chamfer or a radius as the transition element, enter a reduced feedrate in the "FRC" parameter. The slower machining rate means that the transition element is machined more accurately.

Procedure for entering contour elements

1. The part program is opened. Position the cursor at the required input position, this is generally at the physical end of the program after M02 or M30.
2. Contour input using contour support:
 - 2.1 Press the "Contour turning", "Contour" and "New contour" softkeys.



- 2.2 In the opened input window, enter a name for the contour, e.g. contour_1. Press the "Accept" softkey.
- 2.3 The input screen to enter the contour opens, in which you initially enter a starting point for the contour. This is marked in the lefthand navigation bar using the "+" symbol. Press the "Accept" softkey.
3. Enter the individual contour elements of the machining direction. Select a contour element via softkey.



The "Straight line (e.g. Z)" input window opens.

- OR



The "Straight line (e.g. X)" input window opens.

- OR



The "Straight line (e.g. ZX)" input window opens.

- OR



The "Circle" input window opens.

4. Enter all the data available from the workpiece drawing in the input screen (e.g. length of straight line, target position, transition to next element, angle of lead, etc.).



5. Press the "Accept" softkey.

The contour element is added to the contour.



6. When entering data for a contour element, you can program the transition to the preceding element as a tangent.

Press the "Tangent to prec. elem." softkey. The "tangential" selection appears in the parameter $\alpha 2$ entry field.

7. Repeat the procedure until the contour is complete.



8. Press the "Accept" softkey.

The programmed contour is transferred into the process plan (program view).

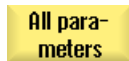







9. If you want to display further parameters for certain contour elements, e.g. to enter additional commands, press the "All parameters" softkey.









Contour element "Straight line e.g. Z"

Parameters	Description	Unit
Z	End point Z (abs or inc)	mm
$\alpha 1$	Starting angle to Z axis	Degrees
$\alpha 2$	Angle to the preceding element	Degrees
Transition to next element	Type of transition <ul style="list-style-type: none"> • Radius • Undercut • Chamfer 	
Radius	R Transition to following element - radius	mm







10.3 Contour turning

Parameters	Description		Unit
Undercut 	Form E	Undercut size  e.g. E1.0x0.4	
	Form F	Undercut size  e.g. F0.6x0.3	
	DIN thread	P α Thread pitch Insertion angle	mm/rev Degrees
	Thread	Z1 Length Z1 Z2 Length Z2 R1 Radius R1 R2 Radius R2 T Insertion depth	mm mm mm mm mm
Chamfer	FS	Transition to following element - chamfer	mm
CA	Grinding allowance  <ul style="list-style-type: none">  Grinding allowance to right of contour  Grinding allowance to left of contour 		mm
Additional commands	Additional G code commands		











Contour element "Straight line e.g. X"

Parameters	Description		Unit
X 	End point X ∅ (abs) or end point X (inc)		mm
α1	Starting angle to Z axis		Degrees
α2	Angle to the preceding element		Degrees
Transition to next element 	Type of transition <ul style="list-style-type: none"> Radius Undercut Chamfer 		
Radius	R	Transition to following element - radius	mm
Undercut 	Form E	Undercut size  e.g. E1.0x0.4	
	Form F	Undercut size  e.g. F0.6x0.3	
	DIN thread	P α Thread pitch Insertion angle	mm/rev Degrees
	Thread	Z1 Length Z1 Z2 Length Z2 R1 Radius R1 R2 Radius R2 T Insertion depth	mm mm mm mm mm
Chamfer	FS	Transition to following element - chamfer	mm
CA	Grinding allowance  <ul style="list-style-type: none">  Grinding allowance to right of contour  Grinding allowance to left of contour 		mm
Additional commands	Additional G code commands		

Contour element "Straight line e.g. ZX"

Parameters	Description	Unit
Z 	End point Z (abs or inc)	mm
X 	End point X \emptyset (abs) or end point X (inc)	mm
$\alpha 1$	Starting angle to Z axis	Degrees
$\alpha 2$	Angle to the preceding element	Degrees
Transition to next element 	Type of transition <ul style="list-style-type: none"> • Radius • Chamfer 	
Radius	R Transition to following element - radius	mm
Chamfer	FS Transition to following element - chamfer	mm
CA	Grinding allowance  <ul style="list-style-type: none"> •  Grinding allowance to right of contour •  Grinding allowance to left of contour 	mm
Additional commands	Additional G code commands	

Contour element "Circle"

Parameters	Description	Unit
Direction of rotation 	<ul style="list-style-type: none"> • Clockwise direction of rotation  • Counterclockwise direction of rotation  	
Z 	End point Z (abs or inc)	mm
X 	End point X \emptyset (abs) or end point X (inc)	mm
K 	Circle center point K (abs or inc)	mm
I 	Circle center point I \emptyset (abs) or circle center point I (inc)	mm
$\alpha 1$	Starting angle to Z axis	Degrees
$\beta 1$	End angle to Z axis	Degrees
$\beta 2$	Opening angle	Degrees
Transition to next element 	Type of transition <ul style="list-style-type: none"> • Radius • Chamfer 	
Radius	R Transition to following element - radius	mm
Chamfer	FS Transition to following element - chamfer	mm
CA	Grinding allowance  <ul style="list-style-type: none"> •  Grinding allowance to right of contour •  Grinding allowance to left of contour 	mm
Additional commands	Additional G code commands	

Contour element "End"

The data for the transition at the contour end of the previous contour element is displayed in the "End" parameter screen.

The values cannot be edited.

10.3.5 Entering the master dimension

If you would like to finish your workpiece to an exact fit, you can input the master dimension directly into the parameter screen form during programming.

Specify the master dimension as follows:

F<Diameter/Length> <Tolerance class> <Tolerance quality>

"F" identifies that a master dimension follows, i.e. in this case, a hole.

Example: F20h7

Possible tolerance classes:

A, B, C, D, E, F, G, H, J, T, U, V, X, Y, Z

Upper-case characters: Holes

Lower case letters: Shafts

Possible tolerance qualities:

1 to 18, if they are not restricted by DIN standard 7150.

Fit calculator

A fit calculator supports you when making entries.

Procedure

1. Position the cursor on the desired entry field.
 2. Press the <=> key.
The calculator is displayed.
 3. Press the "Fit shaft" or "Fit hole" softkey.
"F" (for hole) or "f" (for shaft) is automatically inserted in front of the entry fields for diameter or length data, tolerance class and tolerance quality.
 4. Enter the diameter or length value in the first field.
 5. In the second field, select the tolerance class and in the third field, enter the tolerance quality.
 6. Press the equals symbol on the calculator.
- OR -

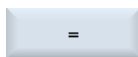



Press the "Calculate" softkey.

- OR -



Press the <INPUT> key.

The new value is calculated and displayed in the entry field of the calculator.



Press the "Accept" softkey.

The calculated value is accepted and displayed in the entry field of the window.

Rejecting entries



Press the "Delete" softkey to reject your entries.

10.3.6 Changing the contour

Function

You can change a previously created contour later.

Individual contour elements can be

- added,
- changed,
- inserted or
- deleted.

Procedure for changing a contour element

1. Open the part program or ShopTurn program to be executed.
2. With the cursor, select the program block where you want to change the contour. Open the geometry processor.
The individual contour elements are listed.
3. Position the cursor at the position where a contour element is to be inserted or changed.
4. Select the desired contour element with the cursor.
5. Enter the parameters in the input screen or delete the element and select a new element.



6. Press the "Accept" softkey.

The desired contour element is inserted in the contour or changed.

Procedure for deleting a contour element



1. Open the part program or ShopTurn program to be executed.
2. Position the cursor on the contour element that you want to delete.
3. Press the "Delete element" softkey.
4. Press the "Delete" softkey.

10.3.7 Contour call (CYCLE62) - only for G code program

Function

The input creates a reference to the selected contour.

There are four ways to call the contour:

1. Contour name
The contour is in the calling main program.
2. Labels
The contour is in the calling main program and is limited by the labels that have been entered.
3. Subprogram
The contour is located in a subprogram in the same workpiece.
4. Labels in the subprogram
The contour is in a subprogram and is limited by the labels that have been entered.

Procedure



1. The part program to be executed has been created and you are in the editor.
2. Press the "Contour turning" softkey.
3. Press the "Contour" and "Contour call" softkeys.
The "Contour Call" input window opens.
4. Assign parameters to the contour selection.

Parameter	Description	Unit
Contour selection 	<ul style="list-style-type: none"> Contour name Labels Subprogram Labels in the subprogram 	
Contour name	CON: Contour name	
Labels	<ul style="list-style-type: none"> LAB1: Label 1 LAB2: Label 2 	
Subprogram	PRG: Subprogram	
Labels in the subprogram	<ul style="list-style-type: none"> PRG: Subprogram LAB1: Label 1 LAB2: Label 2 	

Note**EXTCALL / EES**

When calling a part program via EXTCALL without EES, the contour can only be called via "Contour name" and/or "Labels". This is monitored in the cycle, which means that contour calls via "subprogram" or "labels in subprogram" are only possible if EES is active.

10.3.8 Stock removal (CYCLE952)**Function**

You can use the "Stock removal" function to machine contours in the longitudinal or transverse direction or parallel to the contour.

Blank

For stock removal, the cycle takes into account a blank that can comprise a cylinder, an allowance on the finished-part contour or any blank contour. You must define a blank contour as a separate closed contour in advance of the finished-part contour.

If the blank and finished-part contours do not intersect, the cycles defines the boundary between blank and finished part. If the angle between the straight line and the Z axis is greater than 1°, the boundary is placed at the top - and if the angle is less than or equal to 1°, the boundary is placed at the side.

10.3 Contour turning

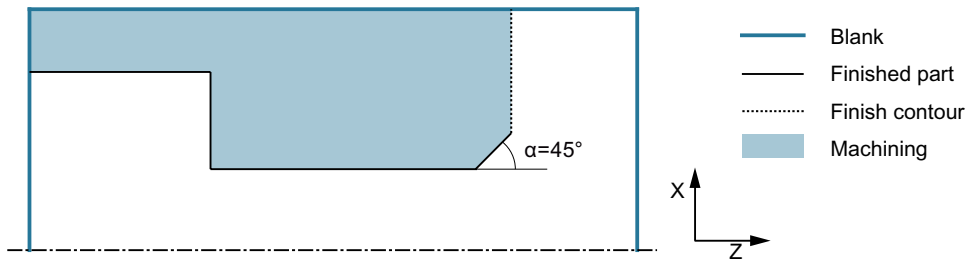

Figure 10-4 $\alpha > 1^\circ$: Boundary between unmachined and finished parts at the top

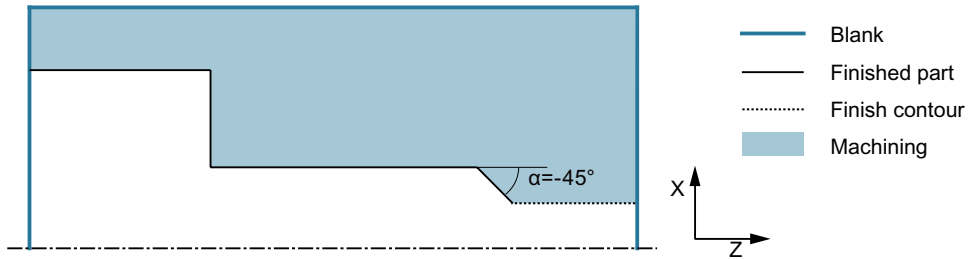

Figure 10-5 $\alpha \leq 1^\circ$: Boundary between unmachined and finished parts at the side

Requirement

For a G code program, at least one CYCLE62 is required before CYCLE952.

If CYCLE62 is only present once, then this involves the finished part contour.

If CYCLE62 is present twice, then the first call is the blank contour and the second call is the finished-part contour (see also Section "Programming (Page 436)").

Note

Execution from external media

If you execute programs from an external drive (e.g. local drive or network drive), you require the "Execution from external storage (EES)" function.

For additional information, please refer to the following documentation:

[SINUMERIK Operate Commissioning Manual](#)

Rule

With the "Execution from External Storage (EES)" function, you have the option to access any logical drive with part programs – and to directly process them as if through the NC program memory.

Rounding the contour

In order to avoid residual corners during roughing, you can enable the "Always round the contour" function. This will remove the protrusions that are always left at the end with each cut (due to the cut geometry). The "Round to the previous intersection" setting accelerates machining of the contour. However, any resulting residual corners will not be recognized or machined. Thus, it is imperative that you check the behavior before machining using the simulation.

When set to "automatic", rounding is always performed if the angle between the cutting edge and the contour exceeds a certain value. The angle is set in a machine data element.



Machine manufacturer

Please observe the information provided by the machine manufacturer.

Alternating cutting depth

Instead of working with constant cutting depth D , you can use an alternating cutting depth to vary the load on the tool edge. As a consequence you can increase the tool life.

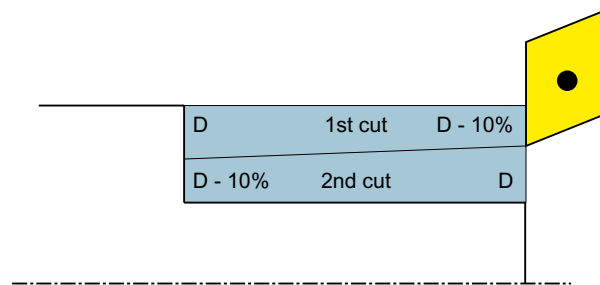

Figure 10-6 Alternating cutting depth

The percentage for the alternating cutting depth is saved in a machine data element.



Machine manufacturer

Please observe the information provided by the machine manufacturer.

Cut segmentation

To avoid the occurrence of very thin cuts in cut segmentation due to contour edges, you can align the cut segmentation to the contour edges. During machining the contour is then divided by the edges into individual sections and cut segmentation is performed separately for each section.

Set machining area limits

If, for example, you want to machine a certain area of the contour with a different tool, you can set machining area limits so that machining only takes place in the area of the contour you have selected. You can define between 1 and 4 limit lines.

The limit lines must not intersect the contour on the side facing the machining.

This limit has the same effect during roughing and finishing.

Example of the limit in longitudinal external machining

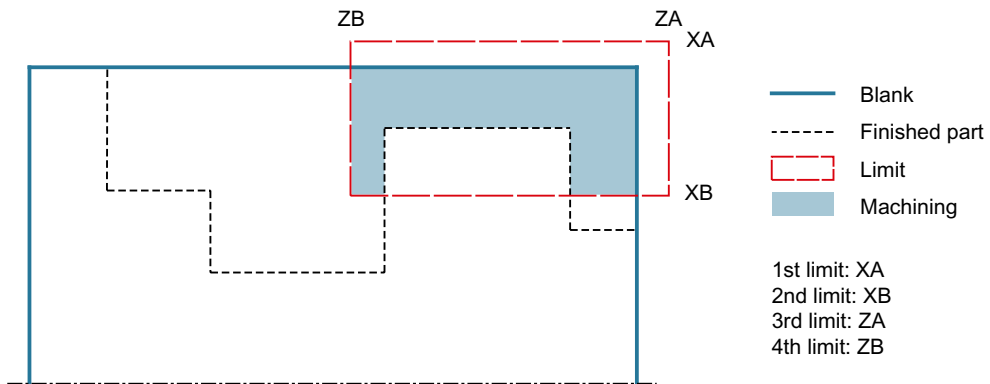

Figure 10-7 Permitted limit: Limit line XA is outside the contour of the blank

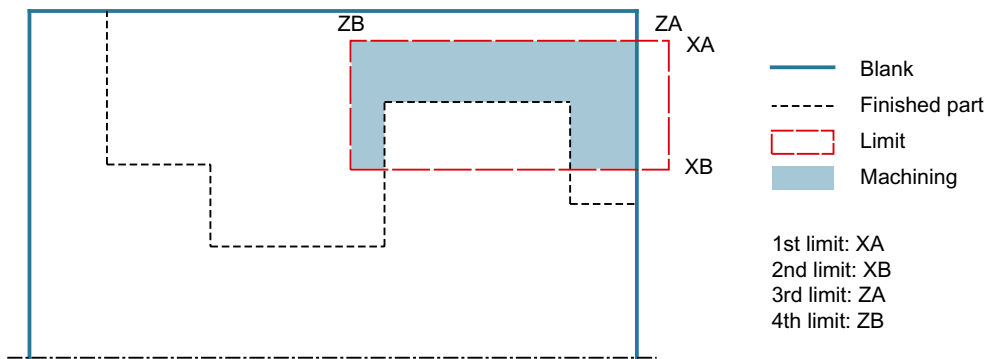

Figure 10-8 Impermissible limit: Limit line XA is inside the contour of the blank

Feedrate interruption

To prevent the occurrence of excessively long chips during machining, you can program a feedrate interruption. Parameter DI specifies the distance after which the feedrate interruption should occur.

The interruption time or retraction distance is defined in machine data.



Machine manufacturer

Please observe the information provided by the machine manufacturer.

Residual material machining / naming conventions

G code program

For multi-channel systems, cycles attach a "_C" and a two-digit number of the specific channel to the names of the programs to be generated, e.g. for channel 1 "_C01".

This is the reason why the name of the main program must not end with "_C" and a two-digit number. This is monitored by the cycles.

For programs with residual machining, when specifying the name for the file, which includes the updated blank contour, it must be ensured that this does not have the attached characters ("_C" and double-digit number).

For single-channel systems, cycles do not extend the name for the programs to be generated.

Note

G code program

For G code programs, the programs to be generated, which do not include any path data, are saved in the directory in which the main program is located. In this case, it must be ensured that programs, which already exist in the directory and which have the same name as the programs to be generated, are overwritten.

Input simple

For simple machining operations, you have the option to reduce the wide variety of parameters to the most important parameters using the "Input" selection field. In this "Input simple" mode, the hidden parameters are allocated a fixed value that cannot be adjusted.



Machine manufacturer

Various defined values can be pre-assigned using setting data.

Please observe the information provided by the machine manufacturer.

If the workpiece programming requires it, you can display and change all of the parameters using "Input complete".

Machining type

You can freely select the machining type (roughing, finishing or complete machining - roughing + finishing). During contour roughing, parallel cuts of maximum programmed infeed depth are created. Roughing is performed to the programmed allowance.



You can also specify a compensation allowance U1 for finishing operations, which allows you to either finish several times (positive allowance) or to shrink the contour (negative allowance). Finishing is performed in the same direction as roughing.











Procedure















1. The part program or ShopTurn program to be processed has been created and you are in the editor.
2. Press the "Contour turning" softkey.
3. Press the "Stock removal" softkey.
The "Stock Removal" input window opens.





10.3 Contour turning

G code program parameters			ShopTurn program parameters		
Input			• Complete		
PRG	Name of the program to be generated		T	Tool name	
PL	Machining plane		D	Cutting edge number	
RP	Retraction plane – (only for machining direction, longitudinal, inner)	mm	F	Feedrate	mm/rev
SC	Safety clearance	mm	S / V 	Spindle speed or constant cutting rate	m/min
F	Feedrate	*			
Residual material 	With subsequent residual material removal. • Yes • No				
CONR	Name to save the updated blank contour for residual material removal				

Parameter	Description	Unit
Machining 	<ul style="list-style-type: none"> ∇ (roughing) ∇∇∇ (finishing) ∇+∇∇∇ (complete machining) 	
Machining direction 	<ul style="list-style-type: none"> Face  Longitudinal  Parallel to the contour  <ul style="list-style-type: none"> From inside to outside  From outside to inside  From end face to rear side  From rear side to end face  	
	The machining direction depends on the stock removal direction and choice of tool.	
Position 	<ul style="list-style-type: none"> Front Rear Inside Outside 	
D	Maximum depth infeed - (only for ∇)	mm
DX	Maximum depth infeed - (only for parallel to the contour, as an alternative to D).	mm

Parameter	Description	Unit
   	Always round on the contour Never round on the contour Only round to the previous intersection.	
  	Uniform cut segmentation Round cut segmentation at the edge	
  	Constant cutting depth Alternating cutting depth - (only with align cut segmentation to edge)	
DZ	Maximum depth infeed - (only for position parallel to the contour and UX)	mm
UX or U 	Finishing allowance in X or finishing allowance in X and Z – (only for ∇)	mm
UZ	Finishing allowance in Z – (only for UX)	mm
DI	For zero: Continuous cut - (only for ∇)	mm
BL 	Blank description (only for ∇) <ul style="list-style-type: none"> • Cylinder (described using XD, ZD) • Allowance (XD and ZD on the finished part contour) • Contour (additional CYCLE62 call with blank contour – e.g. cast iron mold) 	
XD	- (only for ∇ machining) - (only for blank description, cylinder and allowance) <ul style="list-style-type: none"> • For blank description, cylinder <ul style="list-style-type: none"> – Version, absolute: Cylinder dimension \varnothing (abs) – Version incremental: Allowance (inc) to maximum values of the CYCLE62 finished part contour • For blank description, allowance <ul style="list-style-type: none"> – Allowance on the CYCLE62 finished part contour (inc) 	mm
ZD	- (only for ∇ machining) - (only for blank description, cylinder and allowance) <ul style="list-style-type: none"> • For blank description, cylinder <ul style="list-style-type: none"> – Version, absolute: Cylinder dimension (abs) – Version incremental: Allowance (inc) to maximum values of the CYCLE62 finished part contour • For blank description, allowance <ul style="list-style-type: none"> – Allowance on the CYCLE62 finished part contour (inc) 	mm













10.3 Contour turning

Parameter	Description	Unit
Allowance 	Allowance for pre-finishing - (only for ∇∇∇) <ul style="list-style-type: none"> • Yes U1 contour allowance • No 	
U1	Compensation allowance in X and Z direction (inc) – (only for allowance) <ul style="list-style-type: none"> • Positive value: Compensation allowance is retained • Negative value: Compensation allowance is removed in addition to finishing allowance 	mm
Set machining area limits 	Set machining area limits <ul style="list-style-type: none"> • Yes • No 	
XA XB  ZA ZB 	With limited machining area only, yes: 1st limit XA ∅ 2nd limit XB ∅ (abs) or 2nd limit referred to XA (inc) 1st limit ZA 2nd limit ZB (abs) or 2nd limit referred to ZA (inc)	mm
Relief cuts 	Machine relief cuts <ul style="list-style-type: none"> • Yes • No 	
FR	Insertion feedrate, relief cuts	

* Unit of feedrate as programmed before the cycle call

Parameters in the "Input simple" mode

G code program parameters			ShopTurn program parameters		
Input	<ul style="list-style-type: none"> • simple 				
PRG	Name of the program to be generated		T	Tool name	
			D	Cutting edge number	
RP	Retraction plane – (only for machining direction, longitudinal, inner)	mm	F	Feedrate	mm/rev
F	Feedrate	*	S / V 	Spindle speed or constant cutting rate	m/min



Parameter	Description	Unit		
Machining U	<ul style="list-style-type: none"> ∇ (roughing) ∇∇∇ (finishing) ∇+∇∇∇ (complete machining) 			
Machining direction U	<table border="0"> <tr> <td style="vertical-align: top;"> <ul style="list-style-type: none"> face U longitudinal U parallel to the contour U </td> <td style="vertical-align: top;"> <ul style="list-style-type: none"> from inside to outside  from outside to inside  from end face to rear side  from rear side to end face  </td> </tr> </table> <p>The machining direction depends on the stock removal direction and choice of tool.</p>	<ul style="list-style-type: none"> face U longitudinal U parallel to the contour U 	<ul style="list-style-type: none"> from inside to outside  from outside to inside  from end face to rear side  from rear side to end face  	
<ul style="list-style-type: none"> face U longitudinal U parallel to the contour U 	<ul style="list-style-type: none"> from inside to outside  from outside to inside  from end face to rear side  from rear side to end face  			
Position U	<ul style="list-style-type: none"> front back inside outside 			
D	Maximum depth infeed - (only for ∇)	mm		
DX	Maximum depth infeed - (only for parallel to the contour, as an alternative to D)	mm		
DZ	Maximum depth infeed - (only for position parallel to the contour and UX)	mm		
UX or U U	Finishing allowance in X or finishing allowance in X and Z – (only for ∇)	mm		
UZ	Finishing allowance in Z – (only for UX)	mm		
BL U	Blank description (only for ∇) <ul style="list-style-type: none"> Cylinder (described using XD, ZD) Allowance (XD and ZD on the finished part contour) Contour (additional CYCLE62 call with blank contour – e.g. cast iron mold) 			
XD	<p>- (only for ∇ machining)</p> <p>- (only for blank description, cylinder and allowance)</p> <ul style="list-style-type: none"> For blank description, cylinder <ul style="list-style-type: none"> Version, absolute: Cylinder dimension \varnothing (abs) Version incremental: Allowance (inc) to maximum values of the CYCLE62 finished part contour For blank description, allowance <ul style="list-style-type: none"> Allowance on the CYCLE62 finished part contour (inc) 	mm		

10.3 Contour turning

Parameter	Description	Unit
ZD	- (only for ▽ machining) - (only for blank description, cylinder and allowance) <ul style="list-style-type: none"> For blank description, cylinder <ul style="list-style-type: none"> Version, absolute: Cylinder dimension (abs) Version incremental: Allowance (inc) to maximum values of the CYCLE62 finished part contour For blank description, allowance <ul style="list-style-type: none"> Allowance on the CYCLE62 finished part contour (inc) 	mm
Allowance 	Allowance for pre-finishing - (only for ▽▽▽) <ul style="list-style-type: none"> Yes U1 contour allowance No 	
U1	Compensation allowance in X and Z direction (inc) – (only for allowance) <ul style="list-style-type: none"> Positive value: Compensation allowance is kept Negative value: Compensation allowance is removed in addition to finishing allowance 	mm
Relief cuts	Machine relief cuts (cannot be changed)	
FR	Insertion feedrate, relief cuts	

* Unit of feedrate as programmed before the cycle call

Hidden parameters

Parameter	Description	Value	Can be set in SD
PL (only for G code)	Machining plane	Defined in MD 52005	
Residual material	With subsequent residual material removal	No	
SC (only for G code)	Safety clearance		x
Selection	Always round on the contour Uniform cut segmentation Constant cutting depth	  	
DI	Continuous cut - (only for ▽)	0	
Set machining area limits	Set machining area limits	No	
Relief cuts	Machine relief cuts (grayed out)	Yes	



Machine manufacturer

Please refer to the machine manufacturer's specifications.

10.3.9 Stock removal rest (CYCLE952)

Function

Using the "Stock removal residual" function, you remove material that has remained for stock removal along the contour.

During stock removal along the contour, the cycle automatically detects any residual material and generates an updated blank contour. For ShopTurn, the updated unmachined-part contour is automatically generated. For a C code program, for stock removal residual material, "Yes" must be programmed. Material that remains as part of the finishing allowance is not residual material. Using the "Stock removal residual material" function, you can remove unwanted material with a suitable tool.



Software option

For stock removal of residual material, you require the option "residual material detection and machining".

Procedure







1. The part program or ShopTurn program to be processed has been created and you are in the editor.
2. Press the "Contour turning" softkey.
3. Press the "Stock removal residual material" softkey.
The "Stock removal residual material" input window opens.

Parameters, G code program			Parameters, ShopTurn program		
PRG	Name of the program to be generated		T	Tool name	
PL	Machining plane		D	Cutting edge number	
RP	Retraction plane	mm	F	Feedrate	mm/rev

10.3 Contour turning

Parameters, G code program			Parameters, ShopTurn program		
SC	Safety clearance	mm	S / V 	Spindle speed or constant cutting rate	rpm m/min
F	Feedrate	*			
CON	Name of the updated blank contour for residual material machining (without the attached character "_C" and double-digit number)				
Residual material 	With subsequent residual material removal <ul style="list-style-type: none"> • Yes • No 				
CONR	Name to save the updated unmachined-part contour for residual material removal - (only "Yes" for residual material removal)				

Parameters	Description	Unit
Machining 	<ul style="list-style-type: none"> • ∇ (roughing) • ∇∇∇ (finishing) 	
Machining direction 	<ul style="list-style-type: none"> • Face • Longitudinal • Parallel to the contour <ul style="list-style-type: none"> • From inside to outside • From outside to inside • From end face to rear side • From rear side to end face <p>The machining direction depends on the stock removal direction and choice of tool.</p>	
Position 	<ul style="list-style-type: none"> • front • back • internal • external 	
D	Maximum depth infeed - (only for ∇)	mm
XDA	1. Grooving limit tool (abs) – (only for face machining direction)	mm
XDB	2. Grooving limit tool (abs) – (only for face machining direction)	mm
DX	Maximum depth infeed - (only for parallel to the contour, as an alternative to D)	mm
	Do not round contour at end of cut. Always round contour at end of cut.	
	Uniform cut segmentation Round cut segmentation at the edge	
	only for align cut segmentation at the edge: Constant cutting depth alternating cutting depth	

Parameters	Description	Unit
Allowance 	Allowance for pre-finishing - (only for ∇∇∇) <ul style="list-style-type: none"> • Yes U1 contour allowance • No 	s
U1	Compensation allowance in X and Z direction (inc) – (only for allowance) <ul style="list-style-type: none"> • Positive value: Compensation allowance is kept • Negative value: Compensation allowance is removed in addition to finishing allowance 	mm
Set machining area limits 	Set machining area limits <ul style="list-style-type: none"> • Yes • No 	
XA XB  ZA ZB 	with limited machining area only, yes: <ol style="list-style-type: none"> 1. Limit XA ∅ 2. Limit XB ∅ (abs) or 2nd limit referred to XA (inc) <ol style="list-style-type: none"> 1. Limit ZA 2. Limit ZB (abs) or 2nd limit referred to ZA (inc) 	mm
Relief cuts 	Machine relief cuts <ul style="list-style-type: none"> • Yes • No 	
FR	Insertion feedrate, relief cuts	

* Unit of feedrate as programmed before the cycle call

10.3.10 Plunge-cutting (CYCLE952)

Function

The "Grooving" function is used to machine grooves of any shape.

Before you program the groove, you must define the groove contour.

If a groove is wider than the active tool, it is machined in several cuts. The tool is moved by a maximum of 80% of the tool width for each groove.

Blank

When grooving, the cycle takes into account a blank that can consist of a cylinder, an allowance on the finished-part contour or any other blank contour.

Requirement

For a G code program, at least one CYCLE62 is required before CYCLE952.

If CYCLE62 is only present once, then this involves the finished part contour.

10.3 Contour turning

If CYCLE62 is present twice, then the first call is the blank contour and the second call is the finished-part contour (see also Section "Programming (Page 436)").

Note

Execution from external media

If you execute programs from an external drive (e.g. local drive or network drive), you require the "Execution from external storage (EES)" function.

For additional information, please refer to the following documentation:

SINUMERIK Operate Commissioning Manual

Set machining area limits

If, for example, you want to machine a certain area of the contour with a different tool, you can set machining area limits so that machining only takes place in the area of the contour you have selected.

The limit lines must not intersect the contour on the side facing the machining.

This limit has the same effect during roughing and finishing.

Example of the limit in longitudinal external machining

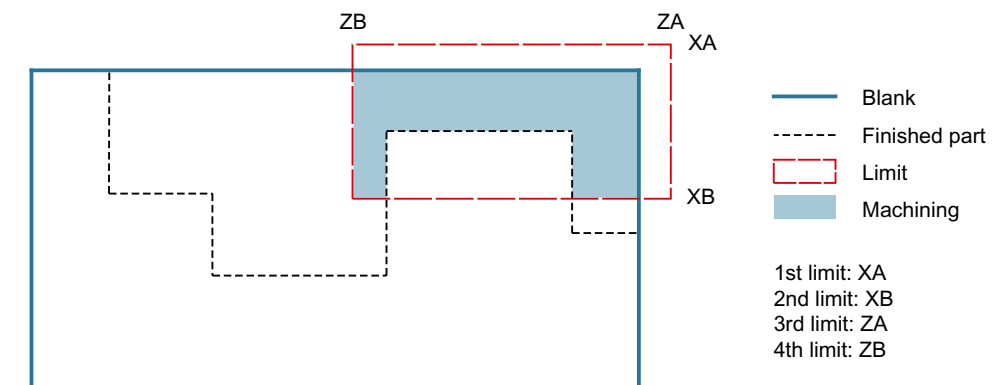

Figure 10-9 Permitted limit: Limit line XA is outside the contour of the blank

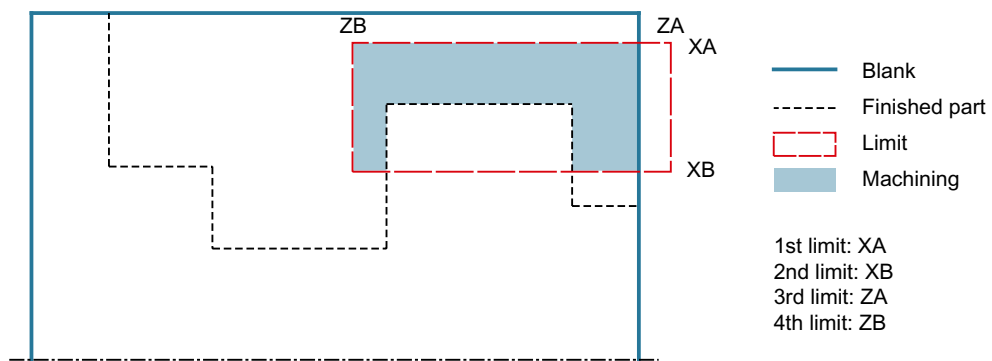

Figure 10-10 Impermissible limit: Limit line XA is inside the contour of the blank

Feedrate interruption

To prevent the occurrence of excessively long chips during machining, you can program a feedrate interruption.

Input simple

For simple machining operations, you have the option to reduce the wide variety of parameters to the most important parameters using the "Input" selection field. In this "Input simple" mode, the hidden parameters are allocated a fixed value that cannot be adjusted.



Machine manufacturer

Various defined values can be pre-assigned using setting data.

Please observe the information provided by the machine manufacturer.

If the workpiece programming requires it, you can display and change all of the parameters using "Input complete".

Machining type

You can freely select the machining type (roughing, finishing or complete machining).

For more detailed information, please refer to section "Stock removal".

Procedure







1. The part program or ShopTurn program to be processed has been created and you are in the editor.
2. Press the "Contour turning" softkey.
3. Press the "Grooving" softkey.
The "Grooving" input window opens.

G code program parameters			ShopTurn program parameters		
Input		• Complete			
PRG	Name of the program to be generated		T	Tool name	
PL	Machining plane		D	Cutting edge number	
RP	Retraction plane – (only for machining direction, longitudinal, inner)	mm	F	Feedrate	mm/rev
SC	Safety clearance	mm	S / V 	Spindle speed or constant cutting rate	rpm m/min
F	Feedrate	*			

10.3 Contour turning

G code program parameters		ShopTurn program parameters		
Residual material U	With subsequent residual material removal <ul style="list-style-type: none"> • Yes • No 			
CONR	Name to save the updated unmachined-part contour for residual material removal - (only "Yes" for residual material removal)			

Parameter	Description	Unit
Machining U	<ul style="list-style-type: none"> • ∇ (roughing) • ∇∇∇ (finishing) • ∇+∇∇∇ (complete machining) 	
Machining direction U	<ul style="list-style-type: none"> • Face • Longitudinal 	
Position U	<ul style="list-style-type: none"> • front • back • Inside • outside 	
D	Maximum depth infeed - (only for ∇)	mm
XDA	1. Grooving limit tool (abs) – (only for face machining direction)	mm
XDB	2. Grooving limit tool (abs) – (only for face machining direction)	mm
UX or U U	Finishing allowance in X or finishing allowance in X and Z – (only for ∇)	mm
UZ	Finishing allowance in Z – (only for UX)	mm
DI	For zero: Continuous cut - (only for ∇)	mm
BL U	Blank description (only for ∇) <ul style="list-style-type: none"> • Cylinder (described using XD, ZD) • Allowance (XD and ZD on the finished part contour) • Contour (additional CYCLE62 call with blank contour – e.g. cast iron mold) 	
XD	- (only for ∇ machining) - (only for blank description, cylinder and allowance) <ul style="list-style-type: none"> • For blank description, cylinder <ul style="list-style-type: none"> – Version, absolute: Cylinder dimension \varnothing (abs) – Version incremental: Allowance (inc) to maximum values of the CYCLE62 finished part contour • For blank description, allowance <ul style="list-style-type: none"> – Allowance on the CYCLE62 finished part contour (inc) 	mm

Parameter	Description	Unit
ZD	- (only for ▽ machining) - (only for blank description, cylinder and allowance) <ul style="list-style-type: none"> For blank description, cylinder <ul style="list-style-type: none"> Version, absolute: Cylinder dimension (abs) Version incremental: Allowance (inc) to maximum values of the CYCLE62 finished part contour For blank description, allowance Allowance on the CYCLE62 finished part contour (inc) 	mm
Allowance 	Allowance for pre-finishing - (only for ▽▽▽) <ul style="list-style-type: none"> Yes U1 contour allowance No 	mm
U1	Compensation allowance in X and Z direction (inc) – (only for allowance) <ul style="list-style-type: none"> Positive value: Compensation allowance is kept Negative value: Compensation allowance is removed in addition to finishing allowance 	mm
Set machining area limits 	Set machining area limits <ul style="list-style-type: none"> Yes No 	
XA XB  ZA ZB 	with limited machining area only, yes: <ol style="list-style-type: none"> Limit XA \emptyset Limit XB \emptyset (abs) or 2nd limit referred to XA (inc) Limit ZA Limit ZB (abs) or 2nd limit referred to ZA (inc) 	mm
N	Number of grooves	
DP	Distance between grooves (inc)	mm

* Unit of feedrate as programmed before the cycle call

Parameters in the "Input simple" mode

G code program parameters			ShopTurn program parameters		
Input		• simple			
PRG	Name of the program to be generated		T	Tool name	
PL	Machining plane		D	Cutting edge number	
RP	Retraction plane – (only for machining direction, longitudinal, inner)	mm	F	Feedrate	mm/rev
F	Feedrate	*	S / V 	Spindle speed or constant cutting rate	m/min

10.3 Contour turning

Parameter	Description	Unit
Machining U	<ul style="list-style-type: none"> ∇ (roughing) ∇∇∇ (finishing) ∇+∇∇∇ (complete machining) 	
Machining direction U	<ul style="list-style-type: none"> Face Longitudinal 	
Position U	<ul style="list-style-type: none"> front back inside outside 	
D	Maximum depth infeed - (only for ∇)	mm
XDA	1. Grooving limit tool (abs) – (only for face machining direction)	mm
XDB	2. Grooving limit tool (abs) – (only for face machining direction)	mm
UX or U U	Finishing allowance in X or finishing allowance in X and Z – (only for ∇)	mm
UZ	Finishing allowance in Z – (only for UX)	mm
BL U	Blank description (only for ∇) <ul style="list-style-type: none"> Cylinder (described using XD, ZD) Allowance (XD and ZD on the finished part contour) Contour (additional CYCLE62 call with blank contour – e.g. cast iron mold) 	
XD	- (only for ∇ machining) - (only for blank description, cylinder and allowance) <ul style="list-style-type: none"> For blank description, cylinder <ul style="list-style-type: none"> Version, absolute: Cylinder dimension ∅ (abs) Version incremental: Allowance (inc) to maximum values of the CYCLE62 finished part contour For blank description, allowance <ul style="list-style-type: none"> Allowance on the CYCLE62 finished part contour (inc) 	mm
ZD	- (only for ∇ machining) - (only for blank description, cylinder and allowance) <ul style="list-style-type: none"> For blank description, cylinder <ul style="list-style-type: none"> Version, absolute: Cylinder dimension (abs) Version incremental: Allowance (inc) to maximum values of the CYCLE62 finished part contour For blank description, allowance <ul style="list-style-type: none"> Allowance on the CYCLE62 finished part contour (inc) 	mm

Parameter	Description	Unit
Allowance 	Allowance for pre-finishing - (only for ∇∇∇) <ul style="list-style-type: none"> • Yes U1 contour allowance • No 	
U1	Compensation allowance in X and Z direction (inc) – (only for allowance) <ul style="list-style-type: none"> • Positive value: Compensation allowance is kept • Negative value: Compensation allowance is removed in addition to finishing allowance 	mm

* Unit of feedrate as programmed before the cycle call

Hidden parameters

Parameter	Description	Value	Can be set in SD
Residual material	With subsequent residual material removal	No	
SC	Safety clearance		x
DI	Continuous cut - (only for ∇)	0	
Set machining area limits	Set machining area limits	No	
N	Number of grooves	1	



Machine manufacturer

Please refer to the machine manufacturer's specifications.

10.3.11 Plunge-cutting rest (CYCLE952)

Function

The "Grooving residual material" function is used when you want to machine the material that remained after grooving along the contour.

During grooving ShopTurn, the cycle automatically detects any residual material and generates an updated blank contour. For a G code program, the function must have been previously selected. Material that remains as part of the finishing allowance is not residual material. The "Grooving residual material" function allows you to remove unwanted material with a suitable tool.



Software option

To machine residual material, you require the "Residual material detection and machining" option.

10.3 Contour turning





Procedure



1. The part program or ShopTurn program to be processed has been created and you are in the editor.
2. Press the "Contour turning" softkey.
3. Press the "Grooving residual material" softkey.
The "Grooving residual material" input window is opened.

Parameters, G code program			Parameters, ShopTurn program		
PRG	Name of the program to be generated		T	Tool name	
PL	Machining plane		D	Cutting edge number	
RP	Retraction plane – (only for longitudinal machining direction)	mm	F	Feedrate	mm/rev
SC	Safety clearance	mm	S / V 	Spindle speed or constant cutting rate	rpm m/min
F	Feedrate	*			
CON	Name of the updated blank contour for residual material machining (without the attached character "_C" and double-digit number)				
Residual material 	With subsequent residual material removal <ul style="list-style-type: none"> • Yes • No 				
CONR	Name to save the updated unmachined-part contour for residual material removal - (only "Yes" for residual material removal)				

parameters	Description	Unit
Machining 	<ul style="list-style-type: none"> • ▽ (roughing) • ▽▽▽ (finishing) 	
Machining direction 	<ul style="list-style-type: none"> • Face • Longitudinal 	
Position 	<ul style="list-style-type: none"> • front • back • internal • external 	
D	Maximum depth infeed - (only for ▽)	mm
XDA	1. Grooving limit tool (abs) – (only for face machining direction)	mm
XDB	2. Grooving limit tool (abs) – (only for face machining direction)	mm
UX or U	Finishing allowance in X or finishing allowance in X and Z – (only for ▽)	mm
UZ	Finishing allowance in Z – (only for UX)	mm
DI	For zero: Continuous cut - (only for ▽)	mm

parameters	Description	Unit
Allowance 	Allowance for pre-finishing - (only for ∇∇∇) <ul style="list-style-type: none"> • Yes U1 contour allowance • No 	mm
U1	Compensation allowance in X and Z direction (inc) – (only for allowance) <ul style="list-style-type: none"> • Positive value: Compensation allowance is kept • Negative value: Compensation allowance is removed in addition to finishing allowance 	mm
Set machining area limits 	Set machining area limits <ul style="list-style-type: none"> • Yes • No 	
XA XB  ZA ZB 	with limited machining area only, yes: <ol style="list-style-type: none"> 1. Limit XA \emptyset 2. Limit XB \emptyset (abs) or 2nd limit referred to XA (inc) <ol style="list-style-type: none"> 1. Limit ZA 2. Limit ZB (abs) or 2nd limit referred to ZA (inc) 	mm
N	Number of grooves	
DP	Distance between grooves (inc)	mm

* Unit of feedrate as programmed before the cycle call

10.3.12 Plunge-turning (CYCLE952)

Function

Using the "Plunge turning" function, you can machine any shape of groove.

Contrary to grooving, the plunge turning function removes material on the sides after the groove has been machined in order to reduce machining time. Contrary to stock removal, the plunge turning function allows you to machine contours that the tool must enter vertically.

You will need a special tool for plunge turning. Before you program the "Plunge turning" cycle, you must define the contour.

Blank

For plunge turning, the cycle takes into account a blank that can consist of a cylinder, an allowance on the finished-part contour or any other blank contour.

Precondition

For a G code program, at least one CYCLE62 is required before CYCLE952.

If CYCLE62 is only present once, then this involves the finished part contour.

If CYCLE62 is present twice, then the first call is the unmachined part contour and the second call is the finished-part contour (also see Chapter "Programming (Page 436)").

Note

Execution from external media

If you execute programs from an external drive (e.g. local drive or network drive), you require the "Execution from external storage (EES)" function.

For additional information, please refer to the following references:

SINUMERIK Operate Commissioning Manual

Set machining area limits

If, for example, you want to machine a certain area of the contour with a different tool, you can set machining area limits so that machining only takes place in the area of the contour you have selected.

The limit lines must not intersect the contour on the side facing the machining.

This limit has the same effect during roughing and finishing.

Example of the limit in longitudinal external machining

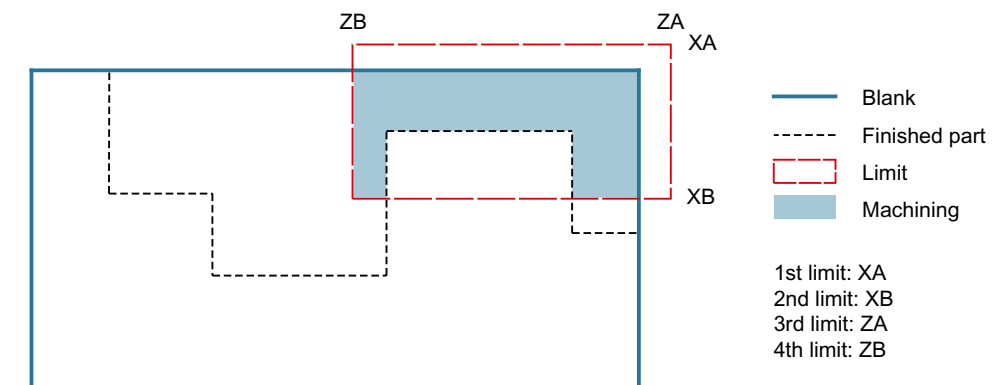

Figure 10-11 Permitted limit: Limit line XA is outside the contour of the blank

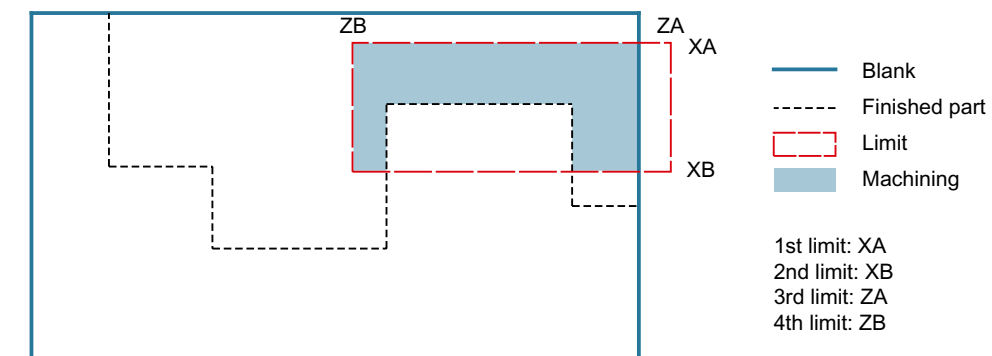

Figure 10-12 Impermissible limit: Limit line XA is inside the contour of the blank

Feedrate interruption

To prevent the occurrence of excessively long chips during machining, you can program a feedrate interruption.

Input simple

For simple machining operations, you have the option to reduce the wide variety of parameters to the most important parameters using the "Input" selection field. In this "Input simple" mode, the hidden parameters are allocated a fixed value that cannot be adjusted.



Machine manufacturer

Various defined values can be pre-assigned using setting data.

Please observe the information provided by the machine manufacturer.

If the workpiece programming requires it, you can display and change all of the parameters using "Input complete".

Machining type

You can freely select the machining type (roughing, finishing or complete machining).

For more detailed information, please refer to section "Stock removal".

Procedure



1. The part program or ShopTurn program to be processed has been created and you are in the editor.
2. Press the "Contour turning" softkey.
3. Press the "Plunge turning" softkey.
The "Plunge turning" input window opens.







Parameters in the "Input complete" mode

G code program parameters		ShopTurn program parameters	
Input	• Complete		
PRG	Name of the program to be generated	T	Tool name

10.3 Contour turning

G code program parameters			ShopTurn program parameters		
PL	Machining plane		D	Cutting edge number	
RP	Retraction plane – (only for machining direction, longitudinal, inner)	mm	S / V	Spindle speed or constant cutting rate	rpm m/min
SC	Safety clearance	mm			
Residual material	With subsequent residual material removal				
	<ul style="list-style-type: none"> • Yes • No 				
CONR	Name to save the updated unmachined-part contour for residual material removal - (only "Yes" for residual material removal)				







Parameter	Description	Unit
FX (only ShopTurn)	Feedrate in X direction	mm/rev
FZ (only ShopTurn)	Feedrate in Z direction	mm/rev
FX (only G Code)	Feedrate in X direction	*
FZ (only for G code)	Feedrate in Z direction	*
Machining	<ul style="list-style-type: none"> • ∇ (roughing) • ∇∇∇ (finishing) • ∇+∇∇∇ (complete machining) 	
Machining direction	<ul style="list-style-type: none"> • Face • Longitudinal 	
Position	<ul style="list-style-type: none"> • front • back • inside • outside 	
D	Maximum depth infeed - (only for ∇)	mm
XDA	1. Grooving limit tool (abs) – (only for face machining direction)	mm
XDB	2. Grooving limit tool (abs) – (only for face machining direction)	mm
UX or U	Finishing allowance in X or finishing allowance in X and Z – (only for ∇)	mm
UZ	Finishing allowance in Z – (only for ∇)	mm
DI	For zero: Continuous cut - (only for ∇)	mm
BL	Blank description (only for ∇) <ul style="list-style-type: none"> • Cylinder (described using XD, ZD) • Allowance (XD and ZD on the finished part contour) • Contour (additional CYCLE62 call with blank contour – e.g. cast iron mold) 	



Parameter	Description	Unit
XD 	<ul style="list-style-type: none"> - (only for ▽ machining) - (only for blank description, cylinder and allowance) • For blank description, cylinder <ul style="list-style-type: none"> – Version, absolute: Cylinder dimension \varnothing (abs) – Version incremental: Allowance (inc) to maximum values of the CYCLE62 finished part contour • For blank description, allowance Allowance on the CYCLE62 finished part contour (inc) 	mm
ZD 	<ul style="list-style-type: none"> - (only for ▽ machining) - (only for blank description, cylinder and allowance) • For blank description, cylinder <ul style="list-style-type: none"> – Version, absolute: Cylinder dimension (abs) – Version incremental: Allowance (inc) to maximum values of the CYCLE62 finished part contour • For blank description, allowance <ul style="list-style-type: none"> – Allowance on the CYCLE62 finished part contour (inc) 	mm
Allowance 	<p>Allowance for pre-finishing - (only for ▽▽▽)</p> <ul style="list-style-type: none"> • Yes U1 contour allowance • No 	mm
U1	<p>Compensation allowance in X and Z direction (inc) – (only for allowance)</p> <ul style="list-style-type: none"> • Positive value: Compensation allowance is kept • Negative value: Compensation allowance is removed in addition to finishing allowance 	mm
Set machining area limits 	<p>Set machining area limits</p> <ul style="list-style-type: none"> • Yes • No 	
XA XB  ZA ZB 	<p>with limited machining area only, yes:</p> <ol style="list-style-type: none"> 1. Limit XA \varnothing 2. Limit XB \varnothing (abs) or 2nd limit referred to XA (inc) 1. Limit ZA 2. Limit ZB (abs) or 2nd limit referred to ZA (inc) 	mm
N	Number of grooves	
DP	Distance between grooves	mm

* Unit of feedrate as programmed before the cycle call

Parameters in the "Input simple" mode

G code program parameters			ShopTurn program parameters		
Input		• simple			
PRG	Name of the program to be generated		T	Tool name	
PL	Machining plane		D	Cutting edge number	
RP	Retraction plane – (only for machining direction, longitudinal, inner)	mm	S / V	Spindle speed or constant cutting rate	m/min

Parameter	Description	Unit
FX (only ShopTurn)	• Feedrate in X direction	mm/rev
FZ (only ShopTurn)	• Feedrate in Z direction	mm/rev
FX (only G Code)	• Feedrate in X direction	*
FZ (only for G code)	• Feedrate in Z direction	*
Machining 	<ul style="list-style-type: none"> • ∇ (roughing) • ∇∇∇ (finishing) • ∇+∇∇∇ (complete machining) 	
Machining direction 	<ul style="list-style-type: none"> • face  • longitudinal  	
Position 	<ul style="list-style-type: none"> • front • back • inside • outside 	
D	Maximum depth infeed - (only for ∇)	mm
XDA	1. Grooving limit tool (abs) – (only for face machining direction)	mm
XDB	2. Grooving limit tool (abs) – (only for face machining direction)	mm
UX or U 	Finishing allowance in X or finishing allowance in X and Z – (only for ∇)	mm
UZ	Finishing allowance in Z – (only for UX)	mm
BL 	Blank description (only for ∇) <ul style="list-style-type: none"> • Cylinder (described using XD, ZD) • Allowance (XD and ZD on the finished part contour) • Contour (additional CYCLE62 call with blank contour – e.g. cast iron mold) 	

Parameter	Description	Unit
XD 	<ul style="list-style-type: none"> - (only for ▽ machining) - (only for blank description, cylinder and allowance) <ul style="list-style-type: none"> • For blank description, cylinder <ul style="list-style-type: none"> – Version, absolute: Cylinder dimension \varnothing (abs) – Version incremental: Allowance (inc) to maximum values of the CYCLE62 finished part contour • For blank description, allowance <ul style="list-style-type: none"> – Allowance on the CYCLE62 finished part contour (inc) 	mm
ZD 	<ul style="list-style-type: none"> - (only for ▽ machining) - (only for blank description, cylinder and allowance) <ul style="list-style-type: none"> • For blank description, cylinder <ul style="list-style-type: none"> – Version, absolute: Cylinder dimension (abs) – Version incremental: Allowance (inc) to maximum values of the CYCLE62 finished part contour • For blank description, allowance <ul style="list-style-type: none"> – Allowance on the CYCLE62 finished part contour (inc) 	mm
Allowance 	<ul style="list-style-type: none"> Allowance for pre-finishing - (only for ▽▽▽) • Yes U1 contour allowance • No 	
U1	<ul style="list-style-type: none"> Compensation allowance in X and Z direction (inc) – (only for allowance) • Positive value: Compensation allowance is kept • Negative value: Compensation allowance is removed in addition to finishing allowance 	mm

* Unit of feedrate as programmed before the cycle call

Hidden parameters

Parameter	Description	Value	Can be set in SD
Residual material	With subsequent residual material removal	No	
SC	Safety clearance		
DI	Continuous cut - (only for ▽)	0	
Set machining area limits	Set machining area limits	No	
N	Number of grooves	1	



Machine manufacturer

Please refer to the machine manufacturer's specifications.

10.3.13 Plunge-turning rest (CYCLE952)

Function

The "Plunge turning residual material" function is used when you want to machine the material that remained after plunge turning.

For plunge turning ShopTurn, the cycle automatically detects any residual material and generates an updated blank contour. For a G code program, the function must have been previously selected in the screen. Material that remains as part of the finishing allowance is not residual material. The "Plunge turning residual material" function allows you to remove unwanted material with a suitable tool.



Software option

To machine residual material, you require the "Residual material detection and machining" option.

Procedure



1. The part program or ShopTurn program to be processed has been created and you are in the editor.











2. Press the "Contour turning" softkey.



3. Press the "Plunge turning residual material" softkey. The "Plunge turning residual material" input window opens.

Parameters, G code program			Parameters, ShopTurn program		
PRG	Name of the program to be generated		T	Tool name	
PL	Machining plane		D	Cutting edge number	
RP	Retraction plane – (only for longitudinal machining direction)	mm	F	Feedrate	mm/rev
SC	Safety clearance	mm	S / V	Spindle speed or constant cutting rate	rpm m/min
CON	Name of the updated blank contour for residual material machining (without the attached character "_C" and double-digit number)				
Residual material	With subsequent residual material removal				
	<ul style="list-style-type: none"> • Yes • No 				
CONR	Name to save the updated unmachined-part contour for residual material removal - (only "Yes" for residual material removal)				

parameters	Description	Unit
FX (only ShopTurn)	Feedrate in X direction	mm/rev
FZ (only ShopTurn)	Feedrate in Z direction	mm/rev
FX (only G Code)	Feedrate in X direction	*
FZ (only for G code)	Feedrate in Z direction	*
Machining 	<ul style="list-style-type: none"> ▽ (roughing) ▽▽▽ (finishing) 	
Machining direction 	<ul style="list-style-type: none"> Face Longitudinal 	
Position 	<ul style="list-style-type: none"> front back internal external 	
D	Maximum depth infeed - (only for ▽)	mm
UX or U 	Finishing allowance in X or finishing allowance in X and Z – (only for ▽)	mm
UZ	Finishing allowance in Z – (only for ▽)	mm
XDA	1. Grooving limit tool \varnothing (abs) – (end face or rear face only)	mm
XDB	2. Grooving limit tool \varnothing (abs) – (end face or rear face only)	mm
Allowance 	Allowance for prefinishing <ul style="list-style-type: none"> Yes U1 contour allowance No 	
DI	For zero: Continuous cut - (only for ▽)	mm
U1	Compensation allowance in X and Z direction (inc) – (only for allowance) <ul style="list-style-type: none"> Positive value: Compensation allowance is kept Negative value: Compensation allowance is removed in addition to finishing allowance 	mm
Set machining area limits 	Set machining area limits <ul style="list-style-type: none"> Yes No 	
XA XB  ZA ZB 	with limited machining area only, yes: <ol style="list-style-type: none"> Limit XA \varnothing Limit XB \varnothing (abs) or 2nd limit referred to XA (inc) Limit ZA Limit ZB (abs) or 2nd limit referred to ZA (inc) 	mm
N	Number of grooves	
DP	Distance between grooves (inc)	mm

* Unit of feedrate as programmed before the cycle call

10.4 Milling

10.4.1 Face milling (CYCLE61)

Function

You can face mill any workpiece with the "Face milling" cycle.

A rectangular surface is always machined. The rectangle is obtained from corner points 1 and 2 - which for a ShopTurn program - are pre-assigned with the values of the blank part dimensions from the program header.

Workpieces with and without limits can be face-milled.

Clamping the spindle

For ShopTurn, the "Clamp spindle" function can be set up by the machine manufacturer.



Machine manufacturer

Please refer to the machine manufacturer's specifications.

See also

Clamping the spindle (Page 293)

Approach/retraction

1. For vertical machining, the starting point is always at the top or bottom. For horizontal machining, it is at the left or right.
The starting point is marked in the help display.
2. Machining is performed from the outside to the inside.

Machining type

The cycle makes a distinction between roughing and finishing:

- Roughing:
Milling the surface
Tool turns above the workpiece edge
- Finishing:
Milling the surface once
Tool turns at safety distance in the X/Y plane
Retraction of milling cutter

Depth infeed always takes place outside the workpiece.

For a workpiece with edge breaking, select the rectangular spigot cycle.

In face milling, the effective tool diameter for a tool of type "Milling cutter" is stored in a machine data item.



Machine manufacturer

Please refer to the machine manufacturer's specifications.

Selecting the machining direction

Toggle the machining direction in the "Direction" field until the symbol for the required machining direction appears.

- Same direction of machining
- Alternating direction of machining

Selecting limits

Press the respective softkey for the required limit.



Left



Top



Bottom



Right



The selected limits are shown in the help screen and in the broken-line graphics.













Procedure









1. The part program or ShopTurn program to be processed has been created and you are in the editor.
2. Press the "Milling" softkey.
3. Press the "Face milling" softkey.
The "Face Milling" input window opens.

10.4 Milling

G code program parameters			ShopTurn program parameters		
PL 	Machining plane		T	Tool name	
RP	Retraction plane	mm	F 	Feedrate	mm/min mm/tooth
SC	Safety clearance	mm	S / V 	Spindle speed or constant cutting rate	rpm m/min
F	Feedrate	*			

Parameter	Description	Unit
Machining surface  (only for Shop-Turn)	<ul style="list-style-type: none"> • Face Y • Peripheral surface Y 	
   (only for Shop-Turn)	Clamp/release spindle The function must be set up by the machine manufacturer.	
Machining 	The following machining technologies can be selected: <ul style="list-style-type: none"> • ▽ (roughing) • ▽▽ (finishing) 	
Direction 	Same direction of machining <ul style="list-style-type: none"> •  •  Alternating direction of machining <ul style="list-style-type: none"> •  •  	
(only for G code) X0 Y0 Z0 X1  Y1  Z1 	The positions refer to the reference point: Corner point 1 in X Corner point 1 in Y Height of blank Corner point 2X (abs) or corner point 2X in relation to X0 (inc) Corner point 2Y (abs) or corner point 2Y in relation to Y0 (inc) Height of blank (abs) or height of blank in relation to Z0 (inc)	mm mm mm mm mm mm

Parameter	Description	Unit
(only ShopTurn) CP	Face Y: The positions refer to the reference point: Positioning angle for machining area - only for face Y Angle CP does not have any effect on the machining position in relation to the workpiece. It is only used to position the workpiece with the rotary axis C in such a way that machining is possible on the machine.	Degrees
X0	Corner point 1 in X	mm
Y0	Corner point 1 in Y	mm
Z0	Height of blank	mm
X1 	Corner point 2 in X (abs) or corner point 2X in relation to X0 (inc)	mm
Y1 	Corner point 2 in Y (abs) or corner point 2Y in relation to Y0 (inc)	mm
Z1 	Height of blank (abs) or height of blank in relation to Z0 (inc)	mm
(only ShopTurn) C0	Peripheral surface Y: The positions refer to the reference point: Positioning angle for machining area - (only for peripheral surface Y)	Degrees
Y0	Corner point 1 in Y	mm
Z0	Corner point 1 in Z	mm
X0	Height of blank	mm
Y1 	Corner point 2 in Y (abs) or corner point 2X in relation to Y0 (inc)	mm
Z1 	Corner point 2 in Z (abs) or corner point 2Y in relation to Z0 (inc)	mm
X1 	Height of blank (abs) or height of blank in relation to X0 (inc)	mm
DXY 	Maximum plane infeed Alternately, you can specify the plane infeed in %, as a ratio → plane infeed (mm) to milling cutter diameter (mm).	mm %
DZ	Maximum depth infeed – (for roughing only)	mm
UZ	Finishing allowance, depth	mm

* Unit of feedrate as programmed before the cycle call

Note

The same finishing allowance must be entered for both roughing and finishing. The finishing allowance is used to position the tool for retraction.

10.4.2 Rectangular pocket (POCKET3)

Function

You can use the "Mill rectangular pocket" cycle to mill any rectangular pockets on the face or peripheral surface.

The following machining variants are available:

- Mill rectangular pocket from solid material.
- Predrill rectangular pocket in the center first if, for example, the milling cutter does not cut in the center (e.g. for ShopTurn, program the drilling, rectangular pocket and position program blocks in succession).
- Machine pre-machined rectangular pocket (see "Solid machining" parameter).
 - Complete machining
 - Post machining

Depending on the dimensions of the rectangular pocket in the workpiece drawing, you can select a corresponding reference point for the rectangular pocket.

Note

Predrilling

If the programmed input parameters, deviating from Pocket3, result in a longitudinal slot or a longitudinal hole, then in the cycle, from Pocket3, the corresponding cycle to machine slots (Slot1 or Longhole) is called. In these cases, the insertion points can deviate from the pocket center.

Note this peculiarity when you predrill.

Clamping the spindle

For ShopTurn, the "Clamp spindle" function can be set up by the machine manufacturer.



Machine manufacturer

Please refer to the machine manufacturer's specifications.

Input simple

For simple machining operations, you have the option to reduce the wide variety of parameters to the most important parameters using the "Input" selection field. In this "Input simple" mode, the hidden parameters are allocated a fixed value that cannot be adjusted.



Machine manufacturer

Various defined values can be pre-assigned using setting data.

Please refer to the machine manufacturer's specifications.

If the workpiece programming requires it, you can display and change all of the parameters using "Input complete".

Approach/retraction

1. The tool approaches the center point of the rectangular pocket in rapid traverse at the height of the retraction plane and adjusts to the safety clearance.
2. The tool is inserted into the material according to the chosen strategy.

3. The rectangular pocket is always machined with the chosen machining type from inside out.
4. The tool moves back to the safety clearance at rapid traverse.

Machining type

- **Roughing**
Roughing involves machining the individual planes of the pocket one after the other from the center out, until depth Z1 or X1 is reached.
- **Finishing**
During finishing, the edge is always machined first. The pocket edge is approached on the quadrant that joins the corner radius. During the last infeed, the base is finished from the center out.
- **Edge finishing**
Edge finishing is performed in the same way as finishing, except that the last infeed (finish base) is omitted.
- **Chamfering**
Chamfering involves edge breaking at the upper edge of the rectangular pocket.

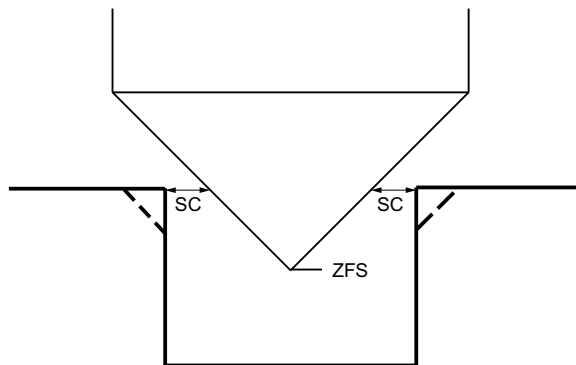

Figure 10-13 Geometries when chamfering inside contours

Note

The following error messages can occur when chamfering inside contours:

- **Safety clearance in the program header too large**
This error message appears when chamfering would, in principle, be possible with the parameters entered for FS and ZFS, but the safety clearance then could not be maintained.
- **Immersion depth too large**
This error message appears when chamfering would be possible through the reduction of the immersion depth ZFS.
- **Tool diameter too large**
This error message appears when the tool would already damage the edges during insertion. In this case, the chamfer FS must be reduced.

Procedure











1. The part program or ShopTurn program to be processed has been created and you are in the editor.
2. Press the "Milling" softkey.
3. Press the "Pocket" and "Rectangular pocket" softkeys. The "Rectangular Pocket" input window opens.





Parameters in the "Input complete" mode



G code program parameters			ShopTurn program parameters		
Input		• Complete			
PL	Machining plane		T	Tool name	
	Milling direction		D	Cutting edge number	
RP	Retraction plane	mm	F	Feedrate	mm/min mm/tooth
SC	Safety clearance	mm	S / V	Spindle speed or constant cutting rate	rpm m/min
F	Feedrate	*			

Parameter	Description	Unit
Reference point (only for G code)	<p>The following different reference point positions can be selected:</p> <ul style="list-style-type: none"> • (center) • (bottom left) • (bottom right) • (top left) • (top right) <p>The reference point (highlighted in blue) is displayed in the Help screen.</p>	
Machining surface (only for Shop-Turn)	<ul style="list-style-type: none"> • Face C • Face Y • Peripheral surface C • Peripheral surface Y 	
Position (only for Shop-Turn)	<ul style="list-style-type: none"> • At the front (face) • At the rear (face) • Outside (peripheral surface) • Inside (peripheral surface) 	

Parameter	Description	Unit
  (only for Shop-Turn)	Clamp/release spindle (only for end face Y/peripheral surface Y) The function must be set up by the machine manufacturer.	
Machining 	The following machining operations can be selected: <ul style="list-style-type: none"> • ▽ (roughing) • ▽▽▽ (finishing) • ▽▽▽ edge (edge finishing) • Chamfering 	
Machining position 	<ul style="list-style-type: none"> • Single position Mill rectangular pocket at the programmed position (X0, Y0, Z0). • Position pattern Position with MCALL 	
X0 Y0 Z0 (only for G code)	The positions refer to the reference point: Reference point X – (only for single position) Reference point Y – (only for single position) Reference point Z	mm mm mm
X0 or L0  Y0 or C0  Z0 (only for Shop-Turn)	Face C: The positions refer to the reference point: Reference point X or reference point length polar – (only for single position) Reference point Y or reference point angle polar - (only for single position) Reference point Z - (only for single position)	mm mm or de- grees mm
CP X0 or L0  Y0 or C0  Z0 (only for Shop-Turn)	Face Y: The positions refer to the reference point: Positioning angle for machining area – (only single position) Angle CP does not have any effect on the machining position in relation to the workpiece. It is only used to position the workpiece with the rotary axis C in such a way that machining is possible on the machine. Reference point X or reference point length polar – (only for single position) Reference point Y or reference point angle polar - (only for single position) Reference point Z - (only for single position)	Degrees mm mm or de- grees mm
Y0 or C0  Z0 X0 (only for Shop-Turn)	Peripheral surface C: The positions refer to the reference point: Reference point Y or reference point angle polar - (only for single position) Reference point Z - (only for single position) Cylinder diameter \varnothing – (only for single position)	mm or de- grees mm mm





10.4 Milling

Parameter	Description	Unit
C0	Peripheral surface Y: The positions refer to the reference point: Positioning angle for machining surface – (only for single position)	Degrees
Y0		mm
Z0		mm
X0		mm
(only for Shop-Turn)		
W	Pocket width	mm
L	Pocket length	mm
R	Corner radius	mm
$\alpha 0$	Angle of rotation	Degrees
Z1	Pocket depth (abs) or depth relative to Z0 (inc) – (only for ∇ , $\nabla\nabla\nabla$ or $\nabla\nabla\nabla$ edge)	mm
 DXY	<ul style="list-style-type: none"> Maximum plane infeed Maximum plane infeed as a percentage of the milling cutter diameter - (only for ∇ and $\nabla\nabla\nabla$)	mm
 DZ		mm
UXY	Plane finishing allowance – (only for ∇ , $\nabla\nabla\nabla$ or $\nabla\nabla\nabla$ edge)	mm
UZ	Depth finishing allowance – (only for ∇ , $\nabla\nabla\nabla$)	mm
Insertion 	The following insertion modes can be selected – (only for ∇ , $\nabla\nabla\nabla$ or $\nabla\nabla\nabla$ edge): <ul style="list-style-type: none"> Predrilled (only for G code) With G0, the pocket center point is approached at the retraction plane level, and then, from this position, also with G0, the axis travels to the reference point brought forward by the safety clearance. The machining of the rectangular pocket is then performed according to the selected insertion strategy, taking into account the programmed blank dimensions. Vertical: Insert vertically at center of pocket The tool executes the calculated actual depth infeed at the pocket center in a single block. This setting can be used only if the cutter can cut across center or if the pocket has been predrilled. Helical: Insert along helical path The cutter center point traverses along the helical path determined by the radius and depth per revolution (helical path). If the depth for one infeed has been reached, a full circle motion is executed to eliminate the inclined insertion path. Oscillating: Insert with oscillation along center axis of rectangular pocket(only for G code) The cutter center point oscillates back and forth along a linear path until it reaches the depth infeed. When the depth has been reached, the path is traversed again without depth infeed in order to eliminate the inclined insertion path. 	
  (only for Shop-Turn)	Clamp/release spindle (only for end face C/peripheral surface C, if inserted vertically) The function must be set up by the machine manufacturer	
FZ (only for G code)	Depth infeed rate – (for vertical insertion only)	*











Parameter	Description	Unit
FZ  (only for Shop-Turn)	Depth infeed rate – (for vertical insertion only)	mm/min mm/tooth
EP	Maximum pitch of helix – (for helical insertion only)	mm/rev
ER	Radius of helix – (for helical insertion only) The radius cannot be any larger than the milling cutter radius; otherwise, material will remain.	mm
EW	Maximum insertion angle – (for insertion with oscillation only)	Degrees
Solid machining (for roughing only) 	<ul style="list-style-type: none"> Complete machining The rectangular pocket is milled from the solid material. Post machining The size of any existing smaller rectangular pocket or hole is increased in one or more axes. You must program parameters AZ, W1 and L1 for this purpose. 	
AZ	Depth of premachining – (for post machining only)	mm
W1	Width of premachining – (for post machining only)	mm
L1	Length of premachining – (for post machining only)	mm
FS	Chamfer width for chamfering - (for chamfering only)	mm
ZFS	Insertion depth of tool tip (abs or inc) – (for chamfering only)	mm





* Unit of feedrate as programmed before the cycle call

Parameters in the "Input simple" mode



G code program parameters			ShopTurn program parameters		
Input 		• simple			
	Milling direction		T	Tool name	
RP	Retraction plane	mm	D	Cutting edge number	
F	Feedrate	*	F 	Feedrate	mm/min mm/rev
			S / V 	Spindle speed or constant cutting rate	rpm m/min

10.4 Milling

Parameter	Description	
Machining 	The following machining operations can be selected: <ul style="list-style-type: none"> ▽ (roughing) ▽▽ (finishing) ▽▽ edge (edge finishing) Chamfering 	
Machining surface (only for ShopTurn) 	<ul style="list-style-type: none"> Face C Face Y Peripheral surface C Peripheral surface Y 	
Position (only for ShopTurn) 	<ul style="list-style-type: none"> At the front (face) At the rear (face) Outside (peripheral surface) Inside (peripheral surface) 	
  (only for ShopTurn) 	Clamp/release spindle (only for end face Y/peripheral surface Y) The function must be set up by the machine manufacturer.	
X0 Y0 Z0 (only for G code)	The positions refer to the reference point: Reference point X Reference point Y Reference point Z	mm mm mm
X0 or L0  Y0 or C0 	Face C: The positions refer to the reference point: Reference point X or reference point length polar Reference point Y or reference point angle polar	mm mm or degrees
Z0 (only for Shop-Turn)	Reference point Z	mm
CP X0 or L0  Y0 or C0 	Face Y: The positions refer to the reference point: Positioning angle for machining area Angle CP does not have any effect on the machining position in relation to the workpiece. It is only used to position the workpiece with the rotary axis C in such a way that machining is possible on the machine. Reference point X or reference point length polar Reference point Y or reference point angle polar	Degrees mm mm or degrees
Z0 (only for Shop-Turn)	Reference point Z	mm

Parameter	Description	
Y0 or C0 	Peripheral surface C: The positions refer to the reference point: Reference point Y or reference point length polar	mm or de- grees
Z0	Reference point Z	mm
X0 (only for ShopTurn)	Cylinder diameter \varnothing	mm
C0	Peripheral surface Y: The positions refer to the reference point: Positioning angle for machining surface	Degrees
Y0	Reference point Y	mm
Z0	Reference point Z	mm
X0 (only for ShopTurn)	Reference point X	mm
W	Pocket width	mm
L	Pocket length	mm
R	Corner radius	mm
Z1 	Depth referred to Z0 (inc) or pocket depth (abs) - (only for ∇ , $\nabla\nabla\nabla$ or $\nabla\nabla\nabla$ edge)	mm
DXY 	<ul style="list-style-type: none"> Maximum plane infeed Maximum plane infeed as a percentage of the milling cutter diameter - (only for ∇ and $\nabla\nabla\nabla$) 	mm %
DZ	Maximum depth infeed – (only for ∇ , $\nabla\nabla\nabla$ or $\nabla\nabla\nabla$ edge)	mm
UXY	Plane finishing allowance – (only for ∇ , $\nabla\nabla\nabla$ or $\nabla\nabla\nabla$ edge)	mm
UZ	Depth finishing allowance – (only for ∇ , $\nabla\nabla\nabla$)	mm
Insertion 	<p>The following insertion modes can be selected – (only for ∇, $\nabla\nabla\nabla$ or $\nabla\nabla\nabla$ edge):</p> <ul style="list-style-type: none"> Predrilled (only for G code) With G0, the pocket center point is approached at the retraction plane level, and then, from this position, also with G0, the axis travels to the reference point brought forward by the safety clearance. The machining of the rectangular pocket is then performed according to the selected insertion strategy, taking into account the programmed blank dimensions. Vertical: Insert vertically at center of pocket The tool executes the calculated actual depth infeed at the pocket center in a single block. This setting can be used only if the cutter can cut across center or if the pocket has been predrilled. Helical: Insert along helical path The cutter center point traverses along the helical path determined by the radius and depth per revolution (helical path). If the depth for one infeed has been reached, a full circle motion is executed to eliminate the inclined insertion path. Oscillating: Insert with oscillation along center axis of rectangular pocket The cutter center point oscillates back and forth along a linear path until it reaches the depth infeed. When the depth has been reached, the path is traversed again without depth infeed in order to eliminate the inclined insertion path. 	

10.4 Milling

Parameter	Description	
  (only for ShopTurn) 	Clamp/release spindle (only for face C/face C, if inserted vertically) The function must be set up by the machine manufacturer	
FZ (only for G code)	Depth infeed rate – (for vertical insertion only)	*
FZ (only for ShopTurn)	Depth infeed rate – (for vertical insertion only)	mm/min mm/tooth
EP	Maximum pitch of helix – (for helical insertion only)	mm/rev
ER	Radius of helix – (for helical insertion only) The radius cannot be any larger than the milling cutter radius; otherwise, material will remain.	mm
EW	Maximum insertion angle – (for insertion with oscillation only)	Degrees
FS	Chamfer width for chamfering - (for chamfering only)	mm
ZFS	Insertion depth of tool tip (abs or inc) – (for chamfering only)	mm

* Unit of feedrate as programmed before the cycle call

Hidden parameters

The following parameters are hidden. They are pre-assigned fixed values or values that can be adjusted using setting data.

Parameter	Description	Value	Can be set in SD
PL (only for G code)	Machining plane	Defined in MD 52005	
SC (only for G code)	Safety clearance	1 mm	x
Reference point	Position of the reference point: Center		
Machining position	Mill rectangular pocket at the programmed position (X0, Y0, Z0).	Single position	
$\alpha 0$	Angle of rotation	0°	
Solid machining	The rectangular pocket is milled from the solid material - (only for roughing)	Complete machining	



Machine manufacturer

Please refer to the machine manufacturer's specifications.

10.4.3 Circular pocket (POCKET4)

Function

You can use the "Circular pocket" cycle to mill circular pockets on the face or peripheral surface.

The following machining variants are available:

- Mill circular pocket from solid material.
- Predrill circular pocket in the center first if, for example, the milling cutter does not cut in the center (program the drilling, circular pocket and position program blocks in succession).

For milling with the "Circular pocket" function two methods are available: the plane-by-plane method and the helical method.

Clamping the spindle

For ShopTurn, the "Clamp spindle" function can be set up by the machine manufacturer.



Machine manufacturer

Please refer to the machine manufacturer's specifications.

Input simple

For simple machining operations, you have the option to reduce the wide variety of parameters to the most important parameters using the "Input" selection field. In this "Input simple" mode, the hidden parameters are allocated a fixed value that cannot be adjusted.



Machine manufacturer

Various defined values can be pre-assigned using setting data.

Please refer to the machine manufacturer's specifications.

If the workpiece programming requires it, you can display and change all of the parameters using "Input complete".

Approach/retraction during plane-by-plane machining

In plane-by-plane machining of the circular pocket, the material is removed horizontally, one layer at a time.

1. The tool approaches the center point of the pocket at rapid traverse at the height of the retraction plane and adjusts to the safety distance.
2. The tool is inserted into the material according to the method selected.
3. The circular pocket is always machined from inside out using the selected machining method.
4. The tool moves back to the safety distance at rapid traverse.

Approach/retraction during helical machining

In helical machining, the material is removed down to pocket depth in a helical movement.

1. The tool approaches the center point of the pocket at rapid traverse at the height of the retraction plane and adjusts to the safety distance.
2. Infeed to the first machining diameter.
3. The circular pocket is machined to pocket depth using the selected machining method.
4. The tool moves back to the safety distance at rapid traverse.

Machining type: Plane by plane

When milling circular pockets, you can select these methods for the following machining types:

- **Roughing**
Roughing involves machining the individual planes of the circular pocket one after the other from the center out, until depth Z1 or X1 is reached.
- **Finishing**
During finishing, the edge is always machined first. The pocket edge is approached on the quadrant that joins the pocket radius. During the last infeed, the base is finished from the center out.
- **Edge finishing**
Edge finishing is performed in the same way as finishing, except that the last infeed (finish base) is omitted.

Machining type: Helical

When milling circular pockets, you can select these methods for the following machining types:

- **Roughing**
During roughing, the circular pocket is machined downward with helical movements. A full circle is made at pocket depth to remove the residual material. The tool is removed from the edge and base in the quadrant and retracted with rapid traverse to the safety distance. This process is repeated layer by layer, from inside out, until the circular pocket has been completely machined.
- **Finishing**
In finishing mode, the edge is machined first with a helical movement down to the bottom. A full circle is made at pocket depth to remove the residual material. The base is milled from outside in, using a spiral movement. The tool is retracted with rapid traverse from the center of the pocket to a safety distance.
- **Edge finishing**
In edge finishing, the edge is machined first with a helical movement down to the bottom. A full circle is made at pocket depth to remove the residual material. The tool is removed from the edge and base in the quadrant and retracted with rapid traverse to the safety distance.

Chamfering machining

Chamfering involves edge breaking at the upper edge of the circular pocket.

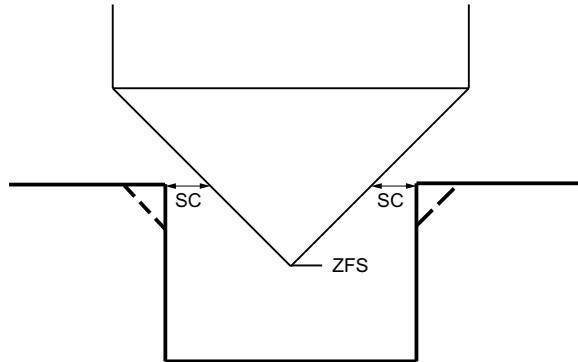

Figure 10-14 Geometries when chamfering inside contours

Note

The following error messages can occur when chamfering inside contours:

- **Safety clearance in the program header too large**
This error message appears when chamfering would, in principle, be possible with the parameters entered for FS and ZFS, but the safety clearance then could not be maintained.
- **Immersion depth too large**
This error message appears when chamfering would be possible through the reduction of the immersion depth ZFS.
- **Tool diameter too large**
This error message appears when the tool would already damage the edges during insertion. In this case, the chamfer FS must be reduced.

Procedure









1. The part program or ShopTurn program to be processed has been created and you are in the editor.
2. Press the "Milling" softkey.
3. Press the "Pocket" and "Circular pocket" softkeys.
The "Circular Pocket" input window opens.





Parameters in the "Input complete" mode

G code program parameters			ShopTurn program parameters		
Input	• Complete				
PL	Machining plane		T	Tool name	
	Milling direction		D	Cutting edge number	
RP	Retraction plane	mm	F	Feedrate	mm/min mm/tooth
SC	Safety clearance	mm	S / V	Spindle speed or constant cutting rate	rpm m/min
F	Feedrate	*			

Parameter	Description	Unit
Machining surface (only for Shop-Turn)	<ul style="list-style-type: none"> • Face C • Face Y • Peripheral surface C • Peripheral surface Y 	
Position (only for Shop-Turn)	<ul style="list-style-type: none"> • At the front (face) • At the rear (face) • Outside (peripheral surface) • Inside (peripheral surface) 	
 (only for Shop-Turn)	Clamp/release spindle (only for end face Y/peripheral surface Y) The function must be set up by the machine manufacturer.	
Machining	<ul style="list-style-type: none"> • ▽ (roughing, plane-by-plane or helical) • ▽▽▽ (finishing, plane-by-plane or helical) • ▽▽▽ edge (edge finishing, plane-by-plane or helical) • Chamfering 	
Machining type	<ul style="list-style-type: none"> • Plane by plane Solid machine circular pocket plane-by-plane • Helical Solid machine circular pocket helically 	
Machining position	<ul style="list-style-type: none"> • Single position A circular pocket is machined at the programmed position (X0, Y0, Z0). • Position pattern Several circular pockets are machined in a position pattern (e.g. full circle, pitch circle, grid, etc.). 	

Parameter	Description	Unit
X0 Y0 Z0 (only for G code)	The positions refer to the reference point: Reference point X – (only for single position) Reference point Y – (only for single position) Reference point Z	mm mm mm
X0 or L0  Y0 or C0  Z0 (only for Shop-Turn)	Face C: The positions refer to the reference point: Reference point X or reference point length polar – (only for single position) Reference point Y or reference point angle polar – (only for single position) Reference point Z – (only for single position)	mm mm or de-grees mm
CP X0 or L0  Y0 or C0  Z0 (only for Shop-Turn)	Face Y: The positions refer to the reference point: Positioning angle for machining area – (only single position) Angle CP does not have any effect on the machining position in relation to the workpiece. It is only used to position the workpiece with the rotary axis C in such a way that machining is possible on the machine. Reference point X or reference point length polar – (only for single position) Reference point Y or reference point angle polar – (only for single position) Reference point Z – (only for single position)	Degrees mm mm or de-grees mm
Y0 or C0  Z0 X0 (only for Shop-Turn)	Peripheral surface C: The positions refer to the reference point: Reference point Y or reference point angle polar – (only for single position) Reference point Z – (only for single position) Cylinder diameter \varnothing – (only for single position)	mm or de-grees mm mm
C0 Y0 Z0 X0 (only for Shop-Turn)	Peripheral surface Y: The positions refer to the reference point: Positioning angle for machining surface – (only for single position) Reference point Y – (only for single position) Reference point Z – (only for single position) Reference point X – (only for single position)	Degrees mm mm mm
\varnothing	Diameter of pocket	mm
Z1 	Pocket depth (abs) or depth relative to Z0/X0 (inc) – (only for ∇ , $\nabla\nabla\nabla$ and $\nabla\nabla\nabla$ edge)	mm
DXY 	<ul style="list-style-type: none"> Maximum plane infeed Maximum plane infeed as a percentage of the milling cutter diameter - (only for ∇ and $\nabla\nabla\nabla$)	in %
DZ	Maximum depth infeed - (only for ∇ , $\nabla\nabla\nabla$ and $\nabla\nabla\nabla$ edge)	mm
UXY	Plane finishing allowance - (only for ∇ , $\nabla\nabla\nabla$ and $\nabla\nabla\nabla$ edge)	mm
UZ	Depth finishing allowance – (only for ∇ and $\nabla\nabla\nabla$)	mm

10.4 Milling

Parameter	Description	Unit
Insertion 	<p>Various insertion modes can be selected – (only for plane-by-plane machining method and for ∇, ∇∇∇ and ∇∇∇ edge):</p> <ul style="list-style-type: none"> • Predrilled (only for G code) • Vertical: Insert vertically at center of pocket The tool executes the calculated depth infeed vertically at the center of the pocket. Feedrate: Infeed rate as programmed under FZ • Helical: Insert along helical path The cutter center point traverses along the helical path determined by the radius and depth per revolution. If the depth for one infeed has been reached, a full circle motion is executed to eliminate the inclined insertion path. Feedrate: Machining feedrate Note: The vertical insertion into pocket center method can be used only if the tool can cut across center or if the workpiece has been predrilled. 	
  (only for Shop-Turn)	<p>Clamp/release spindle (only for end face C/peripheral surface C, if inserted vertically) The function must be set up by the machine manufacturer.</p>	
FZ (only for G code)	Depth infeed rate – (for vertical insertion only)	*
FZ  (only for Shop-Turn)	Depth infeed rate – (for vertical insertion only)	mm/min mm/tooth
EP	<p>Maximum pitch of helix - (for helical insertion only) The helix pitch may be lower due to the geometrical situation.</p>	mm/rev
ER	<p>Radius of helix - (only for helical insertion)</p> <p>The radius must not be larger than the milling cutter radius, otherwise material will remain. Also make sure the circular pocket is not violated.</p>	mm
Solid machining  (only for G code)	<ul style="list-style-type: none"> • Complete machining The circular pocket must be milled from a solid workpiece (e.g. casting). • Post machining A small pocket or hole has already been machined in the workpiece, which needs to be enlarged. Parameters AZ, and Ø1 must be programmed. 	
FS	Chamfer width for chamfering - (for chamfering only)	mm
ZFS	Insertion depth of tool tip (abs or inc) - (for chamfering only)	mm
AZ (only for G code)	Depth of premachining - (for remachining only)	mm
Ø1 (only for G code)	Diameter of premachining - (for remachining only)	mm







* Unit of feedrate as programmed before the cycle call





Parameters in the "Input simple" mode

G code program parameters			ShopTurn program parameters		
Input	• simple				
	Milling direction		T	Tool name	
RP	Retraction plane	mm	D	Cutting edge number	
F	Feedrate	*	F	Feedrate	mm/min mm/rev
			S / V	Spindle speed or constant cutting rate	rpm m/min

Parameter	Description	
Machining surface (only for ShopTurn)	<ul style="list-style-type: none"> • Face C • Face Y • Peripheral surface C • Peripheral surface Y 	
Position (only for ShopTurn)	<ul style="list-style-type: none"> • At the front (face) • At the rear (face) • Outside (peripheral surface) • Inside (peripheral surface) 	
 (only for ShopTurn)	Clamp/release spindle (only for end face Y/peripheral surface Y) The function must be set up by the machine manufacturer.	
Machining	<ul style="list-style-type: none"> • ▽ (roughing) • ▽▽▽ (finishing) • ▽▽▽ edge (edge finishing, plane-by-plane or helical) • Chamfering 	
Machining type	<ul style="list-style-type: none"> • Plane by plane Solid machine circular pocket plane-by-plane • Helical Solid machine circular pocket helically 	
X0 Y0 Z0 (only for G code)	The positions refer to the reference point: Reference point X Reference point Y Reference point Z	mm mm mm

10.4 Milling

Parameter	Description	
X0 or L0  Y0 or C0 	Face C: The positions refer to the reference point: Reference point X or reference point length polar Reference point Y or reference point angle polar	mm mm or degrees
Z0 (only for Shop-Turn)	Reference point Z	mm
CP X0 or L0  Y0 or C0 	Face Y: The positions refer to the reference point: Positioning angle for machining area Angle CP does not have any effect on the machining position in relation to the workpiece. It is only used to position the workpiece with the rotary axis C in such a way that machining is possible on the machine. Reference point X or reference point length polar Reference point Y or reference point angle polar	Degrees mm mm or degrees
Z0 (only for Shop-Turn)	Reference point Z	mm
Y0 or C0  Z0 X0 (only for ShopTurn)	Peripheral surface C: The positions refer to the reference point: Reference point Y or reference point length polar Reference point Z Cylinder diameter \varnothing	mm or degrees mm mm
C0 Y0 Z0 X0 (only for ShopTurn)	Peripheral surface Y: The positions refer to the reference point: Positioning angle for machining surface Reference point Y Reference point Z Reference point X	Degrees mm mm mm
\varnothing	Diameter of pocket	mm
Z1 	Depth referred to Z0/X0 (inc) or pocket depth (abs) - (only for ∇ , $\nabla\nabla\nabla$ or $\nabla\nabla\nabla$ edge)	mm
DXY 	<ul style="list-style-type: none"> Maximum plane infeed Maximum plane infeed as a percentage of the milling cutter diameter - (only for ∇ and $\nabla\nabla\nabla$) 	mm %
DZ	Maximum depth infeed – (only for ∇ , $\nabla\nabla\nabla$ or $\nabla\nabla\nabla$ edge)	mm
UXY	Plane finishing allowance – (only for ∇ , $\nabla\nabla\nabla$ or $\nabla\nabla\nabla$ edge)	mm
UZ	Depth finishing allowance – (only for ∇ , $\nabla\nabla\nabla$)	mm

Parameter	Description	
Insertion 	The following insertion modes can be selected – (only for plane-by-plane machining method and for ▽, ▽▽ or ▽▽▽ edge): <ul style="list-style-type: none"> • Predrilled (only for G code) • Vertical: Insert vertically at center of pocket The tool executes the calculated depth infeed at the pocket center in a single block. This setting can be used only if the cutter can cut across center or if the pocket has been predrilled. • Helical: Insert along helical path The cutter center point traverses along the helical path determined by the radius and depth per revolution (helical path). If the depth for one infeed has been reached, a full circle motion is executed to eliminate the inclined insertion path. Feedrate: Machining feedrate Note: The vertical insertion into pocket center method can be used only if the tool can cut across center or if the workpiece has been predrilled. 	
  (only for ShopTurn) 	Clamp/release spindle (only for end face C/peripheral surface C, if inserted vertically) The function must be set up by the machine manufacturer	
FZ (only for G code)	Depth infeed rate – (for vertical insertion only)	*
FZ (only for ShopTurn)	Depth infeed rate – (for vertical insertion only)	mm/min mm/tooth
EP	Maximum pitch of helix – (for helical insertion only)	mm/rev
ER	Radius of helix – (for helical insertion only) The radius cannot be any larger than the milling cutter radius; otherwise, material will remain.	mm
FS	Chamfer width for chamfering - (for chamfering only)	mm
ZFS	Insertion depth of tool tip (abs or inc) - (for chamfering only)	mm

* Unit of feedrate as programmed before the cycle call

Hidden parameters

The following parameters are hidden. They are pre-assigned fixed values or values that can be adjusted using setting data.

Parameter	Description	Value	Can be set in SD
PL (only for G code)	Machining plane	Defined in MD 52005	
SC (only for G code)	Safety clearance	1 mm	x
Machining position	Mill circular pocket at the programmed position (X0, Y0, Z0).	Single position	
Solid machining	The rectangular pocket is milled from the solid material - (only for roughing)	Complete machining	



Machine manufacturer

Please refer to the machine manufacturer's specifications.

10.4.4 Rectangular spigot (CYCLE76)

Function

You can mill various rectangular spigots with the "Rectangular spigot" cycle.

You can select from the following shapes with or without a corner radius:



In addition to the required rectangular spigot, you must also define a blank spigot. The blank spigot defines the outer limits of the material. The tool moves at rapid traverse in this area. The blank spigot must not overlap adjacent blank spigots and is automatically placed by the cycle in a central position on the finished spigot.

The spigot is machined using only one infeed. If you want to machine the spigot using multiple infeeds, you must program the "Rectangular spigot" function several times, with a continually decreasing finishing allowance.

Clamping the spindle

For ShopTurn you have the option of setting up the "Clamp spindle" function.



Machine manufacturer

Please observe the information provided by the machine manufacturer.

Input simple

For simple machining operations, you have the option of reducing the wide variety of parameters to the most important parameters using the "Input" selection field. In this "Input simple" mode, the hidden parameters are allocated a fixed value that cannot be adjusted.



Machine manufacturer

Various defined values are pre-assigned using setting data.

Please observe the information provided by the machine manufacturer.

If required by the workpiece programming, you can display and change all of the parameters using "Input complete".

Approach/retraction

1. The tool approaches the starting point at rapid traverse at the height of the retraction plane and adjusts to the safety distance. The starting point is on the positive X axis rotated through α_0 .
2. The tool traverses the spigot contour sideways in a semicircle at the machining feedrate. The tool first executes the infeed at machining depth, followed by the movement in the plane. Depending on the machining direction that has been programmed (up-cut/synchronism), the spigot is machined in a clockwise or counterclockwise direction.
3. When the spigot has been circumnavigated once, the tool is removed from the contour in a semicircle; the infeed to the next machining depth is then executed.
4. The spigot is approached again in a semicircle and circumnavigated once. This process is repeated until the programmed spigot depth is reached.
5. The tool moves back to the safety distance at rapid traverse.

Machining type

- Roughing

Roughing involves moving around the rectangular spigot until the programmed finishing allowance has been reached.

- Finishing
If you have programmed a finishing allowance, the rectangular spigot is moved around until depth Z1 is reached.
- Chamfering

Chamfering involves edge breaking at the upper edge of the rectangular spigot.

Procedure









1. The part program or ShopTurn program to be processed has been created and you are in the editor.
2. Press the "Milling" softkey.
3. Press the "Multi-edge spigot" and "Rectangular spigot" softkeys. The "Rectangular Spigot" input window opens.

Parameters in the "Input complete" mode

G code program parameters			ShopTurn program parameters		
Input		• Complete			
PL	Machining plane		T	Tool name	
	Milling direction		D	Cutting edge number	
RP	Retraction plane	mm	F	Feedrate	mm/min mm/tooth
SC	Safety clearance	mm	S / V	Spindle speed or constant cutting rate	rpm m/min
F	Feedrate	*			

Parameter	Description	Unit
FZ (only for G code)	Depth infeed rate (only for ▽ and ▽▽▽)	*
Reference point (only for G code)	The following different reference point positions can be selected: <ul style="list-style-type: none"> (center) (bottom left) (bottom right) (top left) (top right) 	
Machining surface (only for Shop-Turn)	<ul style="list-style-type: none"> Face C Face Y Peripheral surface Y 	
Position (only for Shop-Turn)	<ul style="list-style-type: none"> At the front (face) At the rear (face) Outside (peripheral surface) Inside (peripheral surface) 	
 (only for Shop-Turn)	Clamp/release spindle (only for end face Y/peripheral surface Y) The function must be set up by the machine manufacturer.	
Machining	The following machining operations can be selected: <ul style="list-style-type: none"> ▽ (roughing) ▽▽▽ (finishing) Chamfering 	





Parameter	Description	Unit
Machining position 	<ul style="list-style-type: none"> Single position Mill rectangular pocket at the programmed position (X0, Y0, Z0). Position pattern Position with MCALL 	
X0 Y0 Z0 (only for G code)	The positions refer to the reference point: Reference point X – (only for single position) Reference point Y – (only for single position) Reference point Z	mm mm mm
X0 or L0  Y0 or C0  Z0 (only for Shop-Turn)	Face C: The positions refer to the reference point: Reference point X or reference point length polar – (only for single position) Reference point Y or reference point angle polar – (only for single position) Reference point Z – (only for single position)	mm mm mm
CP X0 or L0  Y0 or C0  Z0 (only for Shop-Turn)	Face Y: The positions refer to the reference point: Positioning angle for machining area – (only single position) Angle CP does not have any effect on the machining position in relation to the workpiece. It is only used to position the workpiece with the rotary axis C in such a way that machining is possible on the machine. Reference point X or reference point length polar – (only for single position) Reference point Y or reference point angle polar – (only for single position) Reference point Z – (only for single position)	Degrees mm mm or degrees mm
Y0 or C0  Z0 X0 (only for Shop-Turn)	Peripheral surface C: The positions refer to the reference point: Reference point Y or reference point angle polar – (only for single position) Reference point Z – (only for single position) Cylinder diameter \varnothing – (only for single position)	mm or degrees mm mm
C0 Y0 Z0 X0 (only for Shop-Turn)	Peripheral surface Y: The positions refer to the reference point: Positioning angle for machining surface – (only for single position) Reference point Y – (only for single position) Reference point Z – (only for single position) Reference point X – (only for single position)	Degrees mm mm mm
W	Width of spigot	mm
L	Length of spigot	mm
R	Corner radius	mm
α_0	Angle of rotation	Degrees
Z1 	Spigot depth (abs) or depth relative to Z0 or X0 (inc) - (only for ∇ and $\nabla\nabla$)	mm





10.4 Milling







Parameter	Description	Unit
DZ	Maximum depth infeed - (only for ▽ and ▽▽▽)	mm
UXY	Plane finishing allowance for the length (L) and width (W) of the rectangular spigot. Smaller rectangular spigot dimensions are obtained by calling the cycle again and programming it with a lower finishing allowance. - (only for ▽ and ▽▽▽)	mm
UZ	Depth finishing allowance (tool axis) - (only for ▽ and ▽▽▽)	mm
W1	Width of blank spigot (important for determining approach position) - (only for ▽ and ▽▽▽)	mm
L1	Length of blank spigot (important for determining approach position) - (only for ▽ and ▽▽▽)	mm
FS	Chamfer width for chamfering - (for chamfering only)	mm
ZFS	Insertion depth of tool tip (abs or inc) - (for chamfering only)	mm

* Unit of feedrate as programmed before the cycle call

Parameters in the "Input simple" mode

G code program parameters			ShopTurn program parameters		
Input 		• simple			
	Milling direction		T	Tool name	
RP	Retraction plane	mm	D	Cutting edge number	
F	Feedrate	*	F 	Feedrate	mm/min mm/rev
			S / V 	Spindle speed or constant cutting rate	rpm m/min

Parameter	Description	
FZ	Depth infeed rate (only for ▽ and ▽▽▽)	*
Machining surface (only for ShopTurn) 	<ul style="list-style-type: none"> • Face C • Face Y • Peripheral surface Y 	
Position (only for ShopTurn) 	<ul style="list-style-type: none"> • At the front (face) • At the rear (face) • Outside (peripheral surface) • Inside (peripheral surface) 	
  (only for ShopTurn) 	Clamp/release spindle (only for end face Y/peripheral surface Y) The function must be set up by the machine manufacturer.	

Parameter	Description	
Machining 	The following machining operations can be selected: <ul style="list-style-type: none"> • ▽ (roughing) • ▽▽▽ (finishing) • Chamfering 	
X0 Y0 Z0 (only for G code)	The positions refer to the reference point: Reference point X Reference point Y Reference point Z	mm mm mm
X0 or L0  Y0 or C0  Z0 (only for Shop-Turn)	Face C: The positions refer to the reference point: Reference point X or reference point length polar Reference point Y or reference point angle polar Reference point Z	mm mm or degrees mm
CP X0 or L0  Y0 or C0  Z0 (only for Shop-Turn)	Face Y: The positions refer to the reference point: Positioning angle for machining area Angle CP does not have any effect on the machining position in relation to the workpiece. It is only used to position the workpiece with the rotary axis C in such a way that machining is possible on the machine. Reference point X or reference point length polar Reference point Y or reference point angle polar Reference point Z	Degrees mm mm or degrees mm
C0 Y0 Z0 X0 (only for ShopTurn)	Peripheral surface Y: The positions refer to the reference point: Positioning angle for machining surface Reference point Y Reference point Z Reference point X	Degrees mm mm mm
W	Width of spigot	mm
L	Length of spigot	mm
R	Corner radius	mm
Z1 	Depth relative to Z0 or X0 (inc) or spigot depth (abs) - (only for ▽ and ▽▽▽)	mm
DZ	Maximum depth infeed – (only for ▽ and ▽▽▽)	mm
UXY	Plane finishing allowance for the length (L) and width (W) of the rectangular spigot. Smaller rectangular spigot dimensions are obtained by calling the cycle again and programming it with a lower finishing allowance. - (only for ▽ and ▽▽▽)	mm
UZ	Depth finishing allowance (tool axis) - (only for ▽ and ▽▽▽)	mm
W1	Width of blank spigot (important for determining approach position) - (only for ▽ and ▽▽▽)	mm
L1	Length of blank spigot (important for determining approach position) - (only for ▽ and ▽▽▽)	mm

10.4 Milling

Parameter	Description	
FS	Chamfer width for chamfering - (for chamfering only)	mm
ZFS	Insertion depth of tool tip (abs and inc) - (for chamfering only)	mm

* Unit of feedrate as programmed before the cycle call

Hidden parameters

The following parameters are hidden. They are pre-assigned fixed values or values that can be adjusted using setting data.

Parameter	Description	Value	Can be set in SD
PL (only for G code)	Machining plane	Defined in MD 52005	
SC (only for G code)	Safety clearance	1 mm	x
Reference point	Position of the reference point: Center		
Machining position	Mill rectangular spigot at the programmed position (X0, Y0, Z0).	Single position	
$\alpha 0$	Angle of rotation	0°	



Machine manufacturer

Please refer to the machine manufacturer's specifications.

10.4.5 Circular spigot (CYCLE77)

Function

You can mill various circular spigots with the "Circular spigot" function.

In addition to the required circular spigot, you must also define a blank spigot, i.e. the outer limits of the material. The tool moves at rapid traverse outside this area. The blank spigot must not overlap adjacent blank spigots and is automatically placed on the finished spigot in a centered position.

The circular spigot is machined using only one infeed. If you want to machine the spigot using multiple infeeds, you must program the "Circular spigot" function several times with a reducing finishing allowance.

Clamping the spindle

For ShopTurn, the "Clamp spindle" function can be set up by the machine manufacturer.



Machine manufacturer

Please refer to the machine manufacturer's specifications.

Input simple

For simple machining operations, you have the option to reduce the wide variety of parameters to the most important parameters using the "Input" selection field. In this "Input simple" mode, the hidden parameters are allocated a fixed value that cannot be adjusted.



Machine manufacturer

Various defined values can be pre-assigned using setting data.

Please refer to the machine manufacturer's specifications.

If the workpiece programming requires it, you can display and change all of the parameters using "Input complete".

Approach/retraction

1. The tool approaches the starting point at rapid traverse at the height of the retraction plane and is fed in to the safety clearance. The starting point is always on the positive X axis.
2. The tool approaches the spigot contour sideways in a semicircle at machining feedrate. The tool first executes infeed at machining depth and then moves in the plane. The circular spigot is machined depending on the programmed machining direction (up-cut/down-cut) in a clockwise or counterclockwise direction.
3. When the circular spigot has been traversed once, the tool retracts from the contour in a semicircle and then infeed to the next machining depth is performed.
4. The circular spigot is approached again in a semicircle and traversed once. This process is repeated until the programmed spigot depth is reached.
5. The tool moves back to the safety clearance at rapid traverse.

Machining type

You can select the machining mode for milling the circular spigot as follows:

- Roughing

Roughing involves moving round the circular spigot until the programmed finishing allowance has been reached.

- Finishing

If you have programmed a finishing allowance, the circular spigot is moved around until depth Z1 is reached.

- Chamfering

Chamfering involves edge breaking at the upper edge of the circular spigot.

10.4 Milling

Procedure



1. The part program or ShopTurn program to be processed has been created and you are in the editor.
2. Press the "Milling" softkey.
3. Press the "Multi-edge spigot" and "Circular spigot" softkeys. The "Circular Spigot" input window opens.



Parameters in the "Input complete" mode

G code program parameters			ShopTurn program parameters		
Input		• Complete			
PL	Machining plane		T	Tool name	
	Milling direction		D	Cutting edge number	
RP	Retraction plane	mm	F	Feedrate	mm/min mm/tooth
SC	Safety clearance	mm	S / V	Spindle speed or constant cutting rate	rpm m/min
F	Feedrate	*			

Parameter	Description	Unit
FZ (only for G code)	Depth infeed rate	*
Machining surface (only for Shop-Turn)	<ul style="list-style-type: none"> • Face C • Face Y • Peripheral surface C • Peripheral surface Y 	
Position (only for Shop-Turn)	<ul style="list-style-type: none"> • At the front (face) • At the rear (face) • Outside (peripheral surface) • Inside (peripheral surface) 	
 (only for Shop-Turn)	Clamp/release spindle (only for end face Y/peripheral surface Y) The function must be set up by the machine manufacturer.	





Parameter	Description	Unit
Machining U	The following machining operations can be selected: <ul style="list-style-type: none"> ▽ (roughing) ▽▽ (finishing) Chamfering 	
Machining position U	<ul style="list-style-type: none"> Single position Mill circular spigot at the programmed position (X0, Y0, Z0). Position pattern Position with MCALL 	
X0 Y0 Z0 (only for G code)	The positions refer to the reference point: Reference point X – (only for single position) Reference point Y – (only for single position) Reference point Z	mm mm mm
X0 or L0 U Y0 or C0 U Z0 (only for Shop-Turn)	Face C: The positions refer to the reference point: Reference point X or reference point length polar – (only for single position) Reference point Y or reference point angle polar – (only for single position) Reference point Z – (only for single position)	mm mm or degrees mm
CP X0 or L0 U Y0 or C0 U Z0 (only for Shop-Turn)	Face Y: The positions refer to the reference point: Positioning angle for machining area – (only single position) Angle CP does not have any effect on the machining position in relation to the workpiece. It is only used to position the workpiece with the rotary axis C in such a way that machining is possible on the machine. Reference point X or reference point length polar – (only for single position) Reference point Y or reference point angle polar – (only for single position) Reference point Z – (only for single position)	Degrees mm mm or degrees mm
Y0 or C0 U Z0 X0 (only for Shop-Turn)	Peripheral surface C: The positions refer to the reference point: Reference point Y or reference point angle polar - (only for single position) Reference point Z - (only for single position) Cylinder diameter \varnothing – (only for single position)	mm or degrees mm mm
C0 Y0 Z0 X0 (only for Shop-Turn)	Peripheral surface Y: The positions refer to the reference point: Positioning angle for machining surface – (only for single position) Reference point Y – (only for single position) Reference point Z – (only for single position) Reference point X – (only for single position)	Degrees mm mm mm
\varnothing	Diameter of spigot	mm



10.4 Milling









Parameter	Description	Unit
Z1 	Spigot depth (abs) or depth relative to Z0 or X0 (inc) - (only for ▽ and ▽▽▽)	mm
DZ	Maximum depth infeed - (only for ▽ and ▽▽▽)	mm
UXY	Plane finishing allowance for the length (L) and width (W) of the circular spigot. Smaller circular spigot dimensions are obtained by calling the cycle again and programming it with a lower finishing allowance - (only for ▽ and ▽▽▽)	mm
UZ	Depth finishing allowance (tool axis) - (only for ▽ and ▽▽▽)	mm
Ø1	Diameter of blank spigot (important for determining approach position) - (only for ▽ and ▽▽▽)	mm
FS	Chamfer width for chamfering - (for chamfering only)	mm
ZFS 	Insertion depth of tool tip (abs or inc) - (for chamfering only) (ZFS for machining surface, face C/Y or XFS for peripheral surface C/Y)	mm

* Unit of feedrate as programmed before the cycle call

Parameters in the "Input simple" mode

G code program parameters			ShopTurn program parameters		
Input 	• simple				
	Milling direction		T	Tool name	
RP	Retraction plane	mm	D	Cutting edge number	
F	Feedrate	*	F 	Feedrate	mm/min mm/rev
			S / V 	Spindle speed or constant cutting rate	rpm m/min

Parameter	Description	
FZ (only for G code)	Depth infeed rate	*
Machining surface (only for ShopTurn) 	<ul style="list-style-type: none"> • Face C • Face Y • Peripheral surface C • Peripheral surface Y 	
Position (only for ShopTurn) 	<ul style="list-style-type: none"> • At the front (face) • At the rear (face) • Outside (peripheral surface) • Inside (peripheral surface) 	

Parameter	Description	
  (only for ShopTurn) 	Clamp/release spindle (only for end face Y/peripheral surface Y) The function must be set up by the machine manufacturer.	
Machining 	The following machining operations can be selected: <ul style="list-style-type: none"> • ▽ (roughing) • ▽▽▽ (finishing) • Chamfering 	
X0 Y0 Z0 (only for G code)	The positions refer to the reference point: Reference point X Reference point Y Reference point Z	mm mm mm
X0 or L0  Y0 or C0  Z0 (only for Shop-Turn)	Face C: The positions refer to the reference point: Reference point X or reference point length polar Reference point Y or reference point angle polar Reference point Z	mm mm or degrees mm
CP X0 or L0  Y0 or C0  Z0 (only for Shop-Turn)	Face Y: The positions refer to the reference point: Positioning angle for machining area Angle CP does not have any effect on the machining position in relation to the workpiece. It is only used to position the workpiece with the rotary axis C in such a way that machining is possible on the machine. Reference point X or reference point length polar Reference point Y or reference point angle polar Reference point Z	Degrees mm mm or degrees mm
Y0 or C0 Z0 X0(only for Shop-Turn)	Peripheral surface C: The positions refer to the reference point: Reference point Y or reference point angle polar Reference point Z Cylinder diameter \varnothing	mm or degrees mm mm
C0 Y0 Z0 X0 (only for ShopTurn)	Peripheral surface Y: The positions refer to the reference point: Positioning angle for machining surface Reference point Y Reference point Z Reference point X	Degrees mm mm mm
$\varnothing 1$	Diameter of blank spigot (important for determining approach position) - (only for ▽ and ▽▽▽)	mm
\varnothing	Diameter of spigot	mm
Z1 	Depth relative to Z0 or X0 (inc) or spigot depth (abs) - (only for ▽ and ▽▽▽)	mm

10.4 Milling

Parameter	Description	
DZ	Maximum depth infeed – (only for ▽ and ▽▽▽)	mm
UXY	Plane finishing allowance for the length (L) and width (W) of the rectangular spigot. Smaller rectangular spigot dimensions are obtained by calling the cycle again and programming it with a lower finishing allowance. - (only for ▽ and ▽▽▽)	mm
UZ	Depth finishing allowance (tool axis) - (only for ▽ and ▽▽▽)	mm
FS	Chamfer width for chamfering - (for chamfering only)	mm
ZFS	Insertion depth of tool tip (abs and inc) - (for chamfering only) (ZFS for machining surface, face C/Y or XFS for peripheral surface C/Y)	mm

* Unit of feedrate as programmed before the cycle call

Hidden parameters

The following parameters are hidden. They are pre-assigned fixed values or values that can be adjusted using setting data.

Parameter	Description	Value	Can be set in SD
PL (only for G code)	Machining plane	Defined in MD 52005	
SC (only for G code)	Safety clearance	1 mm	x
Machining position	Mill circular spigot at the programmed position (X0, Y0, Z0).	Single position	



Machine manufacturer

Please refer to the machine manufacturer's specifications.

10.4.6 Multi-edge (CYCLE79)

Function

You can mill a multi-edge with any number of edges with the "Multi-edge" cycle.

You can select from the following shapes with or without a corner radius or chamfer:

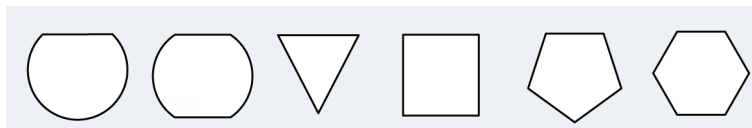

Clamping the spindle

For ShopTurn, the "Clamp spindle" function can be set up by the machine manufacturer.



Machine manufacturer

Please refer to the machine manufacturer's specifications.

Input simple

For simple machining operations, you have the option to reduce the wide variety of parameters to the most important parameters using the "Input" selection field. In this "Input simple" mode, the hidden parameters are allocated a fixed value that cannot be adjusted.



Machine manufacturer

Various defined values can be pre-assigned using setting data.

Please refer to the machine manufacturer's specifications.

If the workpiece programming requires it, you can display and change all of the parameters using "Input complete".

Approach/retraction

1. The tool approaches the starting point at rapid traverse at the height of the retraction plane and is fed in to the safety clearance.
2. The tool traverses the multi-edge in a quadrant at machining feedrate. The tool first executes infeed at machining depth and then moves in the plane. The multi-edge is machined depending on the programmed machining direction (up-cut/down-cut) in a clockwise or counterclockwise direction.
3. When the first plane has been machined, the tool retracts from the contour in a quadrant and then infeed to the next machining depth is performed.
4. The multi-edge is traversed again in a quadrant. This process is repeated until the depth of the multi-edge has been reached.
5. The tool retracts to the safety clearance at rapid traverse.

Note

A multi-edge with more than two edges is traversed helically; with a single or double edge, each edge is machined separately.

Procedure



1. The part program or ShopTurn program to be processed has been created and you are in the editor.
2. Press the "Milling" softkey.
3. Press the "Multi-edge spigot" and "Multi-edge" softkeys. The "Multi-edge" input window opens.

Parameters in the "Input complete" mode

Parameters, G code program			Parameters, ShopTurn program		
Input		• Complete			
PL 	Machining plane		T	Tool name	
	Milling direction		D	Cutting edge number	
RP	Retraction plane	mm	F 	Feedrate	mm/min mm/tooth
SC	Safety clearance	mm	S / V 	Spindle speed or constant cutting rate	rpm m/min
F	Feedrate	*			

Parameter	Description	Unit
Machining surface (only for Shop-Turn)	<ul style="list-style-type: none"> • Face C • Face Y 	
Position (only for Shop-Turn)	<ul style="list-style-type: none"> • Front • back 	
 (only for Shop-Turn)	Clamp/release spindle (only for face Y) The function must be set up by the machine manufacturer.	



Parameter	Description	Unit
Machining U	<ul style="list-style-type: none"> ▽ (roughing) ▽▽ (finishing) ▽▽ edge (edge finishing) Chamfering 	
Machining position U (only for G code)	<ul style="list-style-type: none"> Single position A multiple edge is milled at the programmed position (X0, Y0, Z0). Position pattern Several multiple edges are milled at the programmed position pattern (e.g. pitch circle, grid, line). 	
X0 (only G code)	The positions refer to the reference point: Reference point X – (only for single position)	mm
Y0 (only G code)	Reference point Y – (only for single position)	mm
Z0	Reference point Z – (only for single position)	mm
∅	Diameter of blank spigot	mm
N	Number of edges	
SW or L U	Width across flats or edge length	mm
α0	Angle of rotation	Degrees
R1 or FS1 U	Rounding radius or chamfer width	mm
Z1 U	Multi-edge depth (abs) or depth in relation to Z0 (inc) - (only for ▽, ▽▽ and ▽▽ edge)	mm
DXY U	<ul style="list-style-type: none"> Maximum plane infeed Maximum plane infeed as a percentage of the milling cutter diameter - (only for ▽ and ▽▽) 	mm %
DZ	Maximum depth infeed - (only for ▽ and ▽▽)	mm
UXY	Plane finishing allowance - (only for ▽, ▽▽ and ▽▽ edge)	mm
UZ	Depth finishing allowance – (only for ▽ and ▽▽)	mm
FS	Chamfer width for chamfering - (for chamfering only)	mm
ZFS U	Insertion depth of tool tip (abs or inc) - (for chamfering only)	mm %

* Unit of feedrate as programmed before the cycle call

Parameters in the "Input simple" mode

G code program parameters			ShopTurn program parameters		
Input U		<ul style="list-style-type: none"> simple 			
U	Milling direction		T	Tool name	
RP	Retraction plane	mm	D	Cutting edge number	
F	Feedrate	*	F U	Feedrate	mm/min mm/rev
			S / V U	Spindle speed or constant cutting rate	rpm m/min

10.4 Milling

Parameter	Description	
Machining surface U	<ul style="list-style-type: none"> Face C Face Y 	
Position U (only for ShopTurn)	<ul style="list-style-type: none"> Front Back 	
  (only for ShopTurn)	Clamp/release spindle (only for face C) The function must be set up by the machine manufacturer.	
Machining U	The following machining operations can be selected: <ul style="list-style-type: none"> ▽ (roughing) ▽▽▽ (finishing) ▽▽▽ edge (edge finishing) Chamfering 	
X0 (only G code) Y0 (only G code) Z0	The positions refer to the reference point: Reference point X Reference point Y Reference point Z	mm mm mm
∅	Diameter of blank spigot	mm
N	Number of edges	
SW or L U	Width across flats or edge length	mm
R1 and FS1 U	Rounding radius or chamfer width	
Z1 U	Multi-edge depth (abs) or depth in relation to Z0 (inc) - (only for ▽, ▽▽▽ and ▽▽▽ edge)	mm
DXY U	<ul style="list-style-type: none"> Maximum plane infeed Maximum plane infeed as a percentage of the milling cutter diameter - (only for ▽ and ▽▽▽) 	mm %
DZ	Maximum depth infeed – (only for ▽ and ▽▽▽)	mm
UXY	Plane finishing allowance - (only for ▽, ▽▽▽ and ▽▽▽ edge).	mm
UZ	Depth finishing allowance (only for ▽ and ▽▽▽)	mm
FS	Chamfer width for chamfering - (for chamfering only)	mm
ZFS U	Insertion depth of tool tip (abs or inc) - (for chamfering only)	mm

* Unit of feedrate as programmed before the cycle call

Hidden parameters

The following parameters are hidden. They are pre-assigned fixed values or values that can be adjusted using setting data.

Parameter	Description	Value	Can be set in SD
PL (only for G code)	Machining plane	Defined in MD 52005	
SC (only for G code)	Safety clearance	1 mm	x
Machining position (only for G code)	Mill multi-edge at the programmed position (X0, Y0, Z0).	Single position	
$\alpha 0$	Angle of rotation	0°	



Machine manufacturer

Please refer to the machine manufacturer's specifications.

10.4.7 Longitudinal groove (SLOT1)

Function

You can use the "Longitudinal groove" function to mill any longitudinal groove.

The following machining methods are available:

- Mill longitudinal groove from solid material.
Depending on the dimensions of the longitudinal slot in the workpiece drawing, you can select a corresponding reference point for the longitudinal slot.
- First predrill longitudinal groove if, for example, the milling cutter does not cut in the center (for ShopTurn, program the drilling, longitudinal groove and position program blocks in succession).
In this case, select the predrilling position corresponding to the "Insertion", "vertical" parameter (see "Procedure").
Depending on the dimensions of the longitudinal slot in the workpiece drawing, you can select a corresponding reference point for the longitudinal slot.

Clamping the spindle

For ShopTurn, the "Clamp spindle" function can be set up by the machine manufacturer.



Machine manufacturer

Please refer to the machine manufacturer's specifications.

Longitudinal slot with the width of the tool

When milling a longitudinal slot, which is located in parallel with the spindle axis, and which should be machined with the width of the tool, then the clamping remains active after insertion in order to achieve more accurate results.

The cycles identify this special case and do not cancel clamping after insertion if the following secondary conditions are fulfilled.

After machining, the clamping in the cycles is canceled again.

General conditions

- Finishing longitudinal slot with width = tool diameter
- Roughing longitudinal slot with $(\text{width} - 2 * \text{finishing allowance}) = \text{tool diameter}$

Input simple

For simple machining operations, you have the option to reduce the wide variety of parameters to the most important parameters using the "Input" selection field. In this "Input simple" mode, the hidden parameters are allocated a fixed value that cannot be adjusted.



Machine manufacturer

Various defined values can be pre-assigned using setting data.
Please refer to the machine manufacturer's specifications.

If the workpiece programming requires it, you can display and change all of the parameters using "Input complete".

Approach/retraction

1. The tool approaches the center point of the slot at rapid traverse at the height of the retraction plane and adjusts to the safety distance.
2. The tool is inserted into the material according to the method selected.
3. The longitudinal slot is always machined from inside out using the selected machining method.
4. The tool moves back to the safety distance at rapid traverse.

Machining type

You can select any of the following machining types for milling the longitudinal slot:

- **Roughing**
Roughing involves machining the individual planes of the slot one after the other from the inside out, until depth Z1 or X1 is reached.
- **Finishing**
During finishing, the edge is always machined first. The slot edge is approached on the quadrant that joins the corner radius. During the last infeed, the base is finished from the center out.

- **Edge finishing**
Edge finishing is performed in the same way as finishing, except that the last infeed (finish base) is omitted.
- **Chamfering**
Chamfering involves edge breaking at the upper edge of the longitudinal slot.

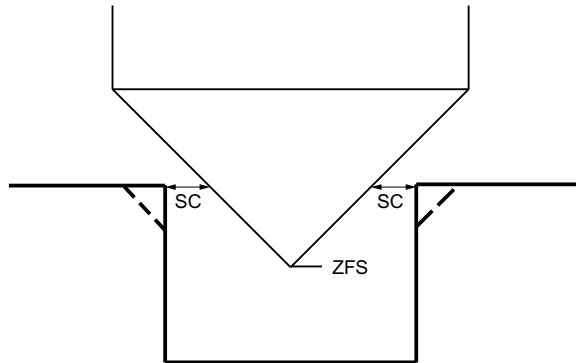

Figure 10-15 Geometries when chamfering inside contours

Note

The following error messages can occur when chamfering inside contours:





- **Safety clearance in the program header too large**
This error message appears when chamfering would, in principle, be possible with the parameters entered for FS and ZFS, but the safety clearance then could not be maintained.
 - **Immersion depth too large**
This error message appears when chamfering would be possible through the reduction of the immersion depth ZFS.
 - **Tool diameter too large**
This error message appears when the tool would already damage the edges during insertion. In this case, the chamfer FS must be reduced.
-











Procedure



1. The part program or ShopTurn program to be processed has been created and you are in the editor.
2. Press the "Milling" softkey.
3. Press the "Groove" and "Longitudinal groove" softkeys.
The "Longitudinal Groove (SLOT1)" input window opens.







Parameters in the "Input complete" mode

G-code program parameters			Parameters, ShopTurn program		
Input		• Complete			
PL 	Machining plane		T	Tool name	
	Milling direction		D	Cutting edge number	
RP	Retraction plane	mm	F 	Feedrate	mm/min mm/tooth
SC	Safety clearance	mm	S / V 	Spindle speed or constant cutting rate	rpm m/min
F	Feedrate	*			

Parameter	Description	Unit
Reference point  (only for G code)	Position of the reference point: <ul style="list-style-type: none">  (lefthand edge)  (inside left)  (center)  (inside right)  (righthand edge) 	
Machining surface  (only for Shop-Turn)	<ul style="list-style-type: none"> Face C Face Y Peripheral surface C Peripheral surface Y 	
Position  (only for Shop-Turn)	<ul style="list-style-type: none"> At the front (face) At the rear (face) Outside (peripheral surface) Inside (peripheral surface) 	
  (only for Shop-Turn)	Clamp/release spindle (only for end face Y/peripheral surface Y) The function must be set up by the machine manufacturer.	
Machining 	The following machining operations can be selected: <ul style="list-style-type: none"> ▽ (roughing) ▽▽ (finishing) ▽▽ edge (edge finishing) Chamfering 	

Parameter	Description	Unit
Machining position U	<ul style="list-style-type: none"> Single position A slot is milled at the programmed position (X0, Y0, Z0). Position pattern Several slots are milled at the programmed position pattern (e.g. pitch circle, grid, line). 	
X0 Y0 Z0 (only for G code)	The positions refer to the reference point: Reference point X – (only for single position) Reference point Y – (only for single position) Reference point Z	mm mm mm
X0 or L0 U Y0 or C0 U Z0 (only for Shop-Turn)	Face C: The positions refer to the reference point: Reference point X or reference point length polar – (only for single position) Reference point Y or reference point angle polar – (only for single position) Reference point Z – (only for single position)	mm mm or de- grees mm
CP X0 or L0 U Y0 or C0 U Z0 (only for Shop-Turn)	Face Y: The positions refer to the reference point: Positioning angle for machining area – (only single position) Angle CP does not have any effect on the machining position in relation to the workpiece. It is only used to position the workpiece with the rotary axis C in such a way that machining is possible on the machine. Reference point X or reference point length polar – (only for single position) Reference point Y or reference point angle polar - (only for single position) Reference point Z - (only for single position)	Degrees mm mm or de- grees mm
Y0 or C0 U Z0 X0 (only for Shop-Turn)	Peripheral surface C: The positions refer to the reference point: Reference point Y or reference point angle polar - (only for single position) Reference point Z - (only for single position) Cylinder diameter \varnothing – (only for single position)	mm or de- grees mm mm
C0 Y0 Z0 X0 (only for Shop-Turn)	Peripheral surface Y: The positions refer to the reference point: Positioning angle for machining surface – (only for single position) Reference point Y – (only for single position) Reference point Z – (only for single position) Reference point X – (only for single position)	Degrees mm mm mm
W	Slot width	mm
L	Slot length	mm
$\alpha 0$	Angle of rotation of slot Face: $\alpha 0$ refers to the X axis or to the position of C0 for a polar reference point Peripheral surface: $\alpha 0$ refers to the Y axis	Degrees

10.4 Milling

Parameter	Description	Unit
Z1 	Slot depth (abs) or depth relative to Z0 or X0 (inc) - (only for ▽ and ▽▽▽)	mm
DXY  (only ShopTurn)	<ul style="list-style-type: none"> • Maximum plane infeed • Maximum plane infeed as a percentage of the milling cutter diameter - (only for ▽ and ▽▽▽)	mm %
DZ	Maximum depth infeed - (only for ▽, ▽▽▽ and ▽▽▽ edge)	mm
UXY	Plane finishing allowance for the length (L) and width (W) of the slot. - (only for ▽ and ▽▽▽)	mm
UZ	Depth finishing allowance (tool axis) - (only for ▽ and ▽▽▽)	mm
Insertion 	The following insertion modes can be selected – (only for ▽, ▽▽▽ or ▽▽▽ edge): <ul style="list-style-type: none"> • Predrilled (only for G code) Approach reference point shifted by the amount of the safety clearance with G0. • Vertical ShopTurn: Depending on the effective milling tool width (milling tool diameter x DXY[%]) or DXY [mm] – at the pocket center or at the pocket edge, is moved to the infeed depth. <ul style="list-style-type: none"> – At the edge of the longitudinal slot ("inside left"): Effective milling tool width >= half the slot width. – At the longitudinal slot center: Effective milling tool width < half the slot width. G code: The tool is inserted to the infeed depth at the reference point "inside left". Note: This setting can be used only if the cutter can cut across center. • Helical (only for G code) Insertion along helical path: The cutter center point traverses along the helical path determined by the radius and depth per revolution (helical path). If the depth for one infeed has been reached, a full longitudinal slot is machined to eliminate the inclined insertion path. • Oscillating Insert with oscillation along center axis of longitudinal slot: The cutter center point oscillates along a linear path until it reaches the depth infeed. When the depth has been reached, the path is traversed again without depth infeed in order to eliminate the inclined insertion path. 	
  (only for Shop-Turn)	Clamp/release spindle (only for end face C/peripheral surface C, if inserted vertically) The function must be set up by the machine manufacturer.	
FZ (only for G code)	Depth infeed rate – (for vertical insertion only)	*
FZ  (only for Shop-Turn)	Depth infeed rate - (only for insertion, predrilled and perpendicular)	mm/min mm/tooth
EP (only for G code)	Maximum pitch of helix – (for helical insertion only)	mm/rev

Parameter	Description	Unit
ER (only for G code)	Radius of helix – (for helical insertion only) The radius cannot be any larger than the milling cutter radius; otherwise, material will remain.	mm
EW	Maximum insertion angle – (for insertion with oscillation only)	Degrees
FS	Chamfer width for chamfering - (for chamfering only)	mm
ZFS 	Insertion depth of tool tip (abs or inc) - (for chamfering only)	mm





Note



Predrilling position

The position at which inserting takes place if "predrilled" is selected is the same position that you select if the reference point "inside left" is specified. In the case of a groove without an angle of rotation, the predrilling position is the center point of the left rounding radius of the groove. When calling the cycle on a position circle, the predrilling position is always the center point of the rounding radius that is closer to the center of the circle.





* Unit of feedrate as programmed before the cycle call







Parameters in the "Input simple" mode

G code program parameters			ShopTurn program parameters		
Input 		• simple			
	Milling direction		T	Tool name	
RP	Retraction plane	mm	D	Cutting edge number	
F	Feedrate	*	F 	Feedrate	mm/min mm/rev
			S / V 	Spindle speed or constant cutting rate	rpm m/min

Parameter	Description	
Machining surface 	<ul style="list-style-type: none"> • Face C • Face Y • Peripheral surface C • Peripheral surface Y 	
Position  (only for ShopTurn)	<ul style="list-style-type: none"> • At the front (face) • At the rear (face) • Outside (peripheral surface) • Inside (peripheral surface) 	

10.4 Milling

Parameter	Description	
  (only for ShopTurn)	Clamp/release spindle (only for end face Y/peripheral surface Y) The function must be set up by the machine manufacturer.	
Machining 	The following machining operations can be selected: <ul style="list-style-type: none"> • ▽ (roughing) • ▽▽▽ (finishing) • ▽▽▽ edge (edge finishing) • Chamfering 	
X0 Y0 Z0 (only for G code)	The positions refer to the reference point: Reference point X Reference point Y Reference point Z	mm mm mm
X0 or L0 Y0 or C0 Z0 (only for ShopTurn)	Face C: The positions refer to the reference point: Reference point X or reference point length polar Reference point Y or reference point angle polar Reference point Z	mm mm or degrees mm
CP X0 or L0 Y0 or C0 Z0 (only for ShopTurn)	Face Y: The positions refer to the reference point: Positioning angle for machining area Angle CP does not have any effect on the machining position in relation to the workpiece. It is only used to position the workpiece with the rotary axis C in such a way that machining is possible on the machine. Reference point X or reference point length polar Reference point Y or reference point angle polar Reference point Z	Degrees mm mm or degrees mm
Y0 or C0  Z0 X0 (only for ShopTurn)	Peripheral surface C: The positions refer to the reference point: Reference point Y or reference point angle polar Reference point Z Cylinder diameter \varnothing	mm or degrees mm mm
C0 Y0 Z0 X0 (only for ShopTurn)	Peripheral surface Y: The positions refer to the reference point: Positioning angle for machining surface Reference point Y Reference point Z Reference point X	Degrees mm mm mm
W	Slot width	mm
L	Slot length	mm
Z1 	Slot depth (abs) or depth relative to Z0 or X0 (inc) - (only for ▽ and ▽▽▽)	mm

Parameter	Description	
DXY  (only for ShopTurn)	<ul style="list-style-type: none"> Maximum plane infeed Maximum plane infeed as a percentage of the milling cutter diameter - (only for ▽ and ▽▽▽) 	mm %
DZ	Maximum depth infeed – (only for ▽ and ▽▽▽)	mm
UXY	Plane finishing allowance for the length (L) and width (W) of the slot (only for ▽ and ▽▽▽).	mm
UZ	Depth finishing allowance (tool axis) - (only for ▽ and ▽▽▽)	mm
Insertion 	The following insertion modes can be selected – (only for ▽, ▽▽▽ or ▽▽▽ edge): <ul style="list-style-type: none"> Predrilled (only for G code) Approach reference point shifted by the amount of the safety clearance with G0. Vertical ShopTurn: Depending on the effective milling tool width (milling tool diameter x DXY[%]) or DXY [mm] – at the pocket center or at the pocket edge, is moved to the infeed depth. <ul style="list-style-type: none"> At the edge of the longitudinal slot ("inside left"): Effective milling tool width >= half the slot width. At the longitudinal slot center: Effective milling tool width < half the slot width. G code: The tool is inserted to the infeed depth at the reference point "inside left". Note: This setting can be used only if the cutter can cut across center. Helical (only for G code) Insertion along helical path: The cutter center point traverses along the helical path determined by the radius and depth per revolution (helical path). If the depth for one infeed has been reached, a full longitudinal slot is machined to eliminate the inclined insertion path. Oscillation Insert with oscillation along center axis of longitudinal slot: The cutter center point oscillates along a linear path until it reaches the depth infeed. When the depth has been reached, the path is traversed again without depth infeed in order to eliminate the inclined insertion path. 	
  (only for ShopTurn)	Clamp/release spindle (only for end face C/peripheral surface C, if inserted vertically) The function must be set up by the machine manufacturer.	
FZ (only for G code)	Depth infeed rate – (for vertical insertion only)	*
FZ  (only for ShopTurn)	Depth infeed rate - (only for insertion, predrilled and perpendicular)	mm/min mm/tooth
EP (only for G code)	Maximum pitch of helix – (for helical insertion only)	mm/rev
ER (only for G code)	Radius of helix – (for helical insertion only) The radius cannot be any larger than the milling cutter radius; otherwise, material will remain.	mm
EW	Maximum insertion angle – (for insertion with oscillation only)	Degrees
FS	Chamfer width for chamfering - (for chamfering only)	mm
ZFS 	Insertion depth of tool tip (abs or inc) - (for chamfering only)	mm

Note

Predrilling position

The position at which inserting takes place if "predrilled" is selected is the same position that you select if the reference point "inside left" is specified. In the case of a groove without an angle of rotation, the predrilling position is the center point of the left rounding radius of the groove. When calling the cycle on a position circle, the predrilling position is always the center point of the rounding radius that is closer to the center of the circle.

* Unit of feedrate as programmed before the cycle call

Hidden parameters

The following parameters are hidden. They are pre-assigned fixed values or values that can be adjusted using setting data.

Parameter	Description	Value	Can be set in SD
PL (only for G code)	Machining plane	Defined in MD 52005	
SC (only for G code)	Safety clearance	1 mm	x
Reference point (only for G code)	Position of the reference point: Center		
Machining position (only for G code)	Mill slot at the programmed position (X0, Y0, Z0)	Single position	
$\alpha 0$	Angle of rotation	0°	



Machine manufacturer

Please refer to the machine manufacturer's specifications.

10.4.8 Circumferential groove (SLOT2)

Function

You can mill one or several circumferential slots of equal size on a full or pitch circle with the "circumferential slot" cycle.

Tool size

Please note that there is a minimum size for the milling cutter used to machine the circumferential slot:

- Roughing:
1/2 groove width W – finishing allowance $UXY \leq$ milling cutter diameter
- Finishing:
1/2 groove width $W \leq$ milling cutter diameter
- Edge finishing:
Finishing allowance $UXY \leq$ milling cutter diameter

Annular groove

To create an annular groove, you must enter the following values for the "Number N" and "Aperture angle $\alpha 1$ " parameters:

$N = 1$

$\alpha 1 = 360^\circ$

Input simple

For simple machining operations, you have the option to reduce the wide variety of parameters to the most important parameters using the "Input" selection field. In this "Input simple" mode, the hidden parameters are allocated a fixed value that cannot be adjusted.



Machine manufacturer

Various defined values can be pre-assigned using setting data.

Please refer to the machine manufacturer's specifications.

If the workpiece programming requires it, you can display and change all of the parameters using "Input complete".

Approach/retraction

1. At the height of the retraction plane, the tool approaches the center point of the semicircle at the end of the groove at rapid traverse and adjusts to the safety distance.
2. It is then inserted into the workpiece at the machining feedrate, allowing for the maximum Z direction infeed (for face machining), X direction infeed (for peripheral machining), and the finishing allowance. Depending on the machining direction (up-cut or down-cut), the circumferential groove is machined in a clockwise or counterclockwise direction.
3. When the first circumferential groove is finished, the tool moves to the retraction plane at rapid traverse.
4. The next circumferential groove is approached along a straight line or circular path and then machined.
5. The rapid traverse feedrate for positioning on a circular path is specified in a machine data element.

Machining type

You can select the machining mode for milling the circumferential groove as follows:

- **Roughing**
During roughing, the individual planes of the groove are machined one after the other from the center point of the semicircle at the end of the groove until depth Z1 is reached.
- **Finishing**
In "Finishing" mode, the edge is always machined first until depth Z1 is reached. The groove edge is approached on the quadrant that joins the radius. In the last infeed, the base is finished from the center point of the semicircle to the end of the groove.
- **Edge finishing**
Edge finishing is performed in the same way as finishing, except that the last infeed (finish base) is omitted.
- **Chamfering**
Chamfering involves edge breaking at the upper edge of the circumferential groove.

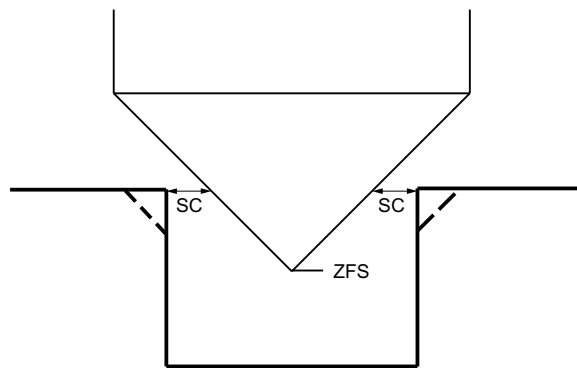

Figure 10-16 Geometries when chamfering inside contours

Note

The following error messages can occur when chamfering inside contours:

- **Safety clearance in the program header too large**
This error message appears when chamfering would, in principle, be possible with the parameters entered for FS and ZFS, but the safety clearance then could not be maintained.
- **Immersion depth too large**
This error message appears when chamfering would be possible through the reduction of the immersion depth ZFS.
- **Tool diameter too large**
This error message appears when the tool would already damage the edges during insertion. In this case, the chamfer FS must be reduced.

Procedure



1. The part program or ShopTurn program to be processed has been created and you are in the editor.
2. Press the "Milling" softkey.
3. Press the "Groove" and "Circumferential groove" softkeys. The "Circumferential Groove" input window opens.



Parameters in the "Input complete" mode

Parameters, G code program			Parameters, ShopTurn program		
Input		• Complete			
PL 	Machining plane		T	Tool name	
	Milling direction		D	Cutting edge number	
RP	Retraction plane	mm	F 	Feedrate	mm/min mm/tooth
SC	Safety clearance	mm	S / V 	Spindle speed or constant cutting rate	rpm m/min
F	Feedrate	*			

Parameter	Description	Unit
 Machining surface (only for Shop-Turn)	<ul style="list-style-type: none"> • Face C • Face Y • Peripheral surface C • Peripheral surface Y 	
 Position (only for Shop-Turn)	<ul style="list-style-type: none"> • At the front (face) • At the rear (face) • Outside (peripheral surface) • Inside (peripheral surface) 	
 (only for Shop-Turn)	Clamp/release spindle (only for end face Y/peripheral surface Y) The function must be set up by the machine manufacturer.	





10.4 Milling

Parameter	Description	Unit
Machining U	<ul style="list-style-type: none"> ▽ (roughing) ▽▽ (finishing) ▽▽ edge (edge finishing) Chamfering 	
FZ (only for G code)	Depth infeed rate	*
Circular pattern U	<ul style="list-style-type: none"> Full circle The circumferential slots are positioned around a full circle. The distance from one circumferential slot to the next circumferential slot is always the same and is calculated by the control. Pitch circle The circumferential slots are positioned around a pitch circle. The distance from one circumferential slot to the next circumferential slot can be defined using angle $\alpha 2$. 	
X0 Y0 Z0 (only for G code)	The positions refer to the reference point: Reference point X – (only for single position) Reference point Y – (only for single position) Reference point Z – (only for single position)	mm mm mm
X0 or L0 U Y0 or C0 U Z0 (only for Shop-Turn)	Face C: The positions refer to the reference point: Reference point X or reference point length polar – (only for single position) Reference point Y or reference point angle polar – (only for single position) Reference point Z – (only for single position)	mm mm or degrees mm
CP X0 or L0 U Y0 or C0 U Z0 (only for Shop-Turn)	Face Y: The positions refer to the reference point: Positioning angle for machining area – (only single position) Angle CP does not have any effect on the machining position in relation to the workpiece. It is only used to position the workpiece with the rotary axis C in such a way that machining is possible on the machine. Reference point X or reference point length polar – (only for single position) Reference point Y or reference point angle polar - (only for single position) Reference point Z - (only for single position)	Degrees mm mm or degrees mm
Y0 or C0 U Z0 X0 (only for Shop-Turn)	Peripheral surface C: The positions refer to the reference point: Reference point Y or reference point angle polar - (only for single position) Reference point Z - (only for single position) Cylinder diameter \varnothing – (only for single position)	mm or degrees mm mm









Parameter	Description	Unit
C0	Peripheral surface Y: The positions refer to the reference point: Positioning angle for machining surface – (only for single position)	Degrees
Y0		mm
Z0		mm
X0		mm
(only for Shop-Turn)		
N	Number of slots	
R	Radius of circumferential slot	mm
$\alpha 0$	Starting angle	Degrees
$\alpha 1$	Opening angle of the slot	Degrees
$\alpha 2$	Advance angle - (for pitch circle only)	Degrees
W	Slot width	mm
Z1 	Slot depth (abs) or depth relative to Z0 or X0 (inc) - (only for ∇ , $\nabla\nabla\nabla$)	mm
DZ	Maximum depth infeed - (only for ∇ , $\nabla\nabla\nabla$)	mm
UXY	Plane finishing allowance – (only for ∇ , $\nabla\nabla\nabla$)	mm
Positioning 	Positioning motion between the slots: <ul style="list-style-type: none"> • Straight line: Next position is approached linearly in rapid traverse. • Circular: Next position is approached along a circular path at the feedrate defined in a machine data code. 	
FS	Chamfer width for chamfering (inc) - (for chamfering only)	mm
ZFS 	Insertion depth of tool tip (abs or inc) - (for chamfering only)	mm







* Unit of feedrate as programmed before the cycle call

Parameters in the "Input simple" mode

G code program parameters			ShopTurn program parameters		
Input 	• simple				
	Milling direction		T	Tool name	
RP	Retraction plane	mm	D	Cutting edge number	
F	Feedrate	*	F 	Feedrate	mm/min mm/rev
			S / V 	Spindle speed or constant cutting rate	rpm m/min

10.4 Milling

Parameter	Description	
Machining surface  (only for ShopTurn)	<ul style="list-style-type: none"> • Face C • Face Y • Peripheral surface C • Peripheral surface Y 	
Position  (only for ShopTurn)	<ul style="list-style-type: none"> • At the front (face) • At the rear (face) • Outside (peripheral surface) • Inside (peripheral surface) 	
  (only for ShopTurn)	Clamp/release spindle (only for end face Y/peripheral surface Y) The function must be set up by the machine manufacturer.	
Machining 	<ul style="list-style-type: none"> • ▽ (roughing) • ▽▽▽ (finishing) • ▽▽▽ edge (edge finishing) • Chamfering 	
FZ (only for G code)	Depth infeed rate	*
Circular pattern 	<ul style="list-style-type: none"> • Full circle The circumferential slots are positioned around a full circle. The distance from one circumferential slot to the next circumferential slot is always the same and is calculated by the control. • Pitch circle The circumferential slots are positioned around a pitch circle. The distance from one circumferential slot to the next circumferential slot can be defined using angle $\alpha 2$. 	
X0 Y0 Z0 (only for G code)	The positions refer to the reference point: Reference point X Reference point Y Reference point Z	mm mm mm
X0 or L0  Y0 or C0  Z0 (only for ShopTurn)	Face C: The positions refer to the reference point: Reference point X or reference point length polar Reference point Y or reference point angle polar Reference point Z	mm mm or degrees mm

Parameter	Description	
CP	Face Y: The positions refer to the reference point: Positioning angle for machining area Angle CP does not have any effect on the machining position in relation to the workpiece. It is only used to position the workpiece with the rotary axis C in such a way that machining is possible on the machine.	Degrees
X0 or L0 	Reference point X or reference point length polar	mm
Y0 or C0 	Reference point Y or reference point angle polar	mm or degrees
Z0 (only for ShopTurn)	Reference point Z	mm
Y0 or C0 	Peripheral surface C: The positions refer to the reference point: Reference point Y or reference point angle polar	mm or degrees
Z0	Reference point Z	mm
X0 (only for ShopTurn)	Cylinder diameter \varnothing	mm
C0	Peripheral surface Y: The positions refer to the reference point: Positioning angle for machining surface	Degrees
Y0	Reference point Y	mm
Z0	Reference point Z	mm
X0 (only for ShopTurn)	Reference point X	mm
N	Number of slots	mm
R	Radius of circumferential slot	Degrees
$\alpha 1$	Opening angle of the slot	Degrees
$\alpha 2$	Advance angle - (for pitch circle only)	Degrees
W	Slot width	mm
Z1 	Slot depth (abs) or depth relative to Z0 or X0 (inc) - (only for ∇ and $\nabla\nabla\nabla$)	mm
DZ	Maximum depth infeed - (only for ∇ and $\nabla\nabla\nabla$)	mm
UXY	Plane finishing allowance - (only for ∇ and $\nabla\nabla\nabla$)	mm
Positioning 	Positioning motion between the slots: <ul style="list-style-type: none"> • Straight line: Next position is approached linearly in rapid traverse. • Circular: Next position is approached along a circular path at the feedrate defined in the machine data. 	mm
FS	Chamfer width for chamfering - (for chamfering only)	mm
ZFS 	Insertion depth of tool tip (abs or inc) - (for chamfering only)	mm

* Unit of feedrate as programmed before the cycle call

Hidden parameters

The following parameters are hidden. They are pre-assigned fixed values or values that can be adjusted using setting data.

Parameter	Description	Value	Can be set in SD
PL (only for G code)	Machining plane	Defined in MD 52005	
SC (only for G code)	Safety clearance	1 mm	x
$\alpha 0$	Angle of rotation	0°	



Machine manufacturer

Please refer to the machine manufacturer's specifications.

10.4.9 Open groove (CYCLE899)

Function

Use the "Open slot" function if you want to machine open slots.

For roughing, you can choose between the following machining strategies, depending on your workpiece and machine properties.

- Vortex milling
- Plunge cutting

The following machining types are available to completely machine the slot:

- Roughing
- Rough-finishing
- Finishing
- Base finishing
- Edge finishing
- Chamfering

Vortex milling

Particularly where hardened materials are concerned, this process is used for roughing and contour machining using coated VHM milling cutters.

Vortex milling is the preferred technique for HSC roughing, as it ensures that the tool is never completely inserted. This means that the set overlap is precisely maintained.

Plunge cutting

Plunge cutting is the preferred method of machining slots for "unstable" machines and workpiece geometries. This method generally only exerts forces along the tool axis, i.e. perpendicular to the surface of the pocket/slot to be machined (with the XY plane in Z direction). Therefore, the tool is subject to virtually no deformation. As a result of the axial loading of the tool, there is hardly any danger of vibration occurring for unstable workpieces.

The cutting depth can be considerably increased. The plunge cutter, as it is known, ensures a longer service life due to less vibration for long overhangs.

Input simple

For simple machining operations, you have the option to reduce the wide variety of parameters to the most important parameters using the "Input" selection field. In this "Input simple" mode, the hidden parameters are allocated a fixed value that cannot be adjusted.



Machine manufacturer

Various defined values can be pre-assigned using setting data.

Please refer to the machine manufacturer's specifications.

If the workpiece programming requires it, you can display and change all of the parameters using "Input complete".

Approach/retraction for vortex milling

1. The tool approaches the starting point in front of the slot in rapid traverse and maintains the safety clearance.
2. The tool goes to the cutting depth.
3. The open slot is always machined along its entire length using the selected machining method.
4. The tool retracts to the safety clearance in rapid traverse.

Approach/retraction for plunge cutting

1. The tool moves in rapid traverse to the starting point in front of the slot at the safety clearance.
2. The open slot is always machined along its entire length using the selected machining method.
3. The tool retracts to the safety clearance in rapid traverse.

Machining type, roughing vortex milling

Roughing is performed by moving the milling cutter along a circular path.

While performing this motion, the milling cutter is continuously fed into the plane. Once the milling cutter has traveled along the entire slot, it returns to its starting point, while continuing to move in a circular fashion. By doing this, it removes the next layer (infeed depth) in the Z

direction. This process is repeated until the set slot depth plus the finishing allowance has been reached.

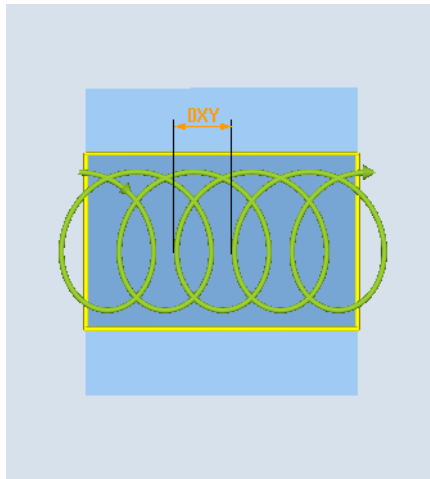

Vortex milling: Down-cut or up-cut

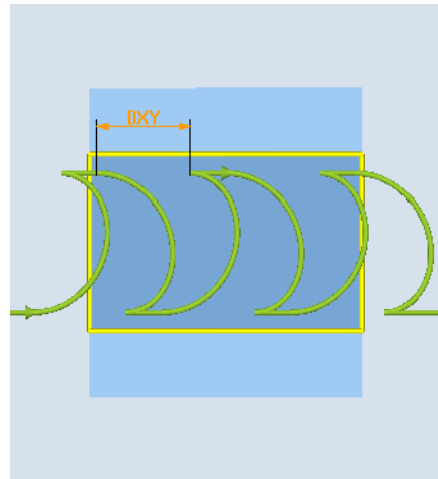

Vortex milling: Down-cut-up-cut

Supplementary conditions for vortex milling

- Roughing
1/2 slot width W – finishing allowance $UXY \leq$ milling cutter diameter
- Slot width
minimum $1.15 \times$ milling cutter diameter + finishing allowance
maximum, $2 \times$ milling cutter diameter + $2 \times$ finishing allowance
- Radial infeed
minimum, $0.02 \times$ milling cutter diameter
maximum, $0.25 \times$ milling cutter diameter
- Maximum infeed depth \leq cutting height of milling cutter

Please note that the cutting height of the milling cutter cannot be checked.

The maximum radial infeed depends on the milling cutter.

For hard materials, use a lower infeed.

Machining type, roughing plunge cutting

Roughing of the slot takes place sequentially along the length of the groove, with the milling cutter performing vertical insertions at the machining feedrate. The milling cutter is then retracted and repositioned at the next insertion point.

The milling cutter moves along the length of the slot, at half the infeed rate, and inserts alternately at the left-hand and right-hand walls.

The first insertion motion takes place at the slot edge, with the milling cutter inserted at half the infeed, less the safety clearance (if the safety clearance is greater than the infeed, this will be on the outside). For this cycle, the maximum width of the slot must be less than double the width of the milling cutter + the finishing allowance.

Following each insertion, the milling cutter is lifted by the height of the safety clearance at the machining feedrate. As far as possible, this occurs during what is known as the retraction process, i.e. if the milling cutter's wrap angle is less than 180° , it is lifted at an angle below 45° in the opposite direction to the bisector of the wrap area.

The milling cutter then traverses over the material in rapid traverse.

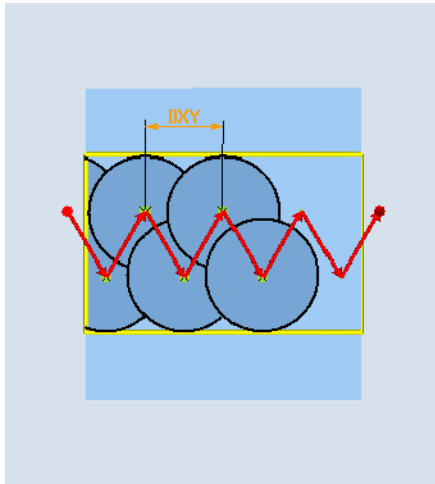

Supplementary conditions for plunge cutting

- Roughing
1/2 slot width W - finishing allowance $UXY \leq$ milling cutter diameter
- Maximum radial infeed
The maximum infeed depends on the cutting edge width of the milling cutter.
- Increment
The lateral increment is calculated on the basis of the required slot width, milling cutter diameter and finishing allowance.
- Retraction
Retraction involves the milling cutter being retracted at a 45° angle if the wrap angle is less than 180° . Otherwise, retraction is perpendicular, as is the case with drilling.
- Retraction
Retraction is performed perpendicular to the wrapped surface.
- Safety clearance
Traverse through the safety clearance beyond the end of the workpiece to prevent rounding of the slot walls at the ends.

Please note that the milling cutter's cutting edge cannot be checked for the maximum radial infeed.

Machining type, rough finishing

If there is too much residual material on the slot walls, unwanted corners are removed to the finishing dimension.

Machining type, finishing:

When finishing walls, the milling cutter travels along the slot walls, whereby just like for roughing, it is again fed in the Z direction, increment by increment. During this process, the milling cutter travels through the safety clearance beyond the beginning and end of the slot, so that an even slot wall surface can be guaranteed across the entire length of the slot.

Machining type, edge finishing

Edge finishing is performed in the same way as finishing, except that the last infeed (finish base) is omitted.

Machining type, finishing base:

When finishing the base, the milling cutter moves backwards and forwards once in the finished slot.

Machining type, chamfering

Chamfering involves breaking the edge at the upper slot edge.

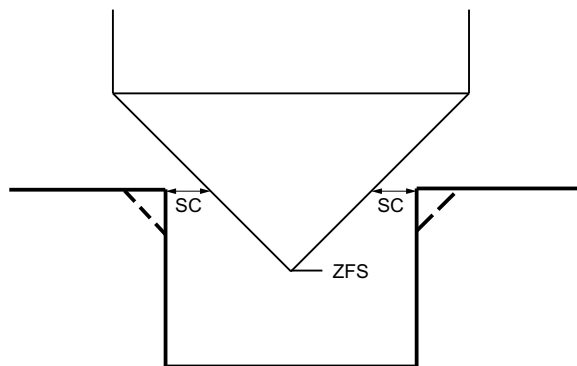

Figure 10-17 Geometries when chamfering inside contours

Note

The following error messages can occur when chamfering inside contours:

- **Safety clearance in the program header too large**
This error message appears when chamfering would, in principle, be possible with the parameters entered for FS and ZFS, but the safety clearance then could not be maintained.
- **Immersion depth too large**
This error message appears when chamfering would be possible through the reduction of the immersion depth ZFS.
- **Tool diameter too large**
This error message appears when the tool would already damage the edges during insertion. In this case, the chamfer FS must be reduced.

Additional supplementary conditions

- Finishing
1/2 slot width $W \leq$ milling cutter diameter
- Edge finishing
Finishing allowance $UXY \leq$ milling cutter diameter
- Chamfering
The tip angle must be entered into the tool table.

Procedure























1. The part program or ShopTurn program to be processed has been created and you are in the editor.
2. Press the "Milling" softkey.
3. Press the "Slot" and "Open slot" softkeys.
The "Open slot" input window opens.

Parameters in the "Input complete" mode

G code program parameters			ShopTurn program parameters		
Input		• Complete			
PL 	Machining plane		T	Tool name	
RP	Retraction plane	mm	D	Cutting edge number	
SC	Safety clearance	mm	F 	Feedrate	mm/min mm/tooth
F	Feedrate	*	S / V 	Spindle speed or constant cutting rate	rpm m/min

10.4 Milling

Parameter	Description	Unit
Machining surface  (only for Shop-Turn)	<ul style="list-style-type: none"> • Face C • Face Y • Peripheral surface C • Peripheral surface Y 	
Position  (only for Shop-Turn)	<ul style="list-style-type: none"> • At the front (face) • At the rear (face) • Outside (peripheral surface) • Inside (peripheral surface) 	
  (only for Shop-Turn)	Clamp/release spindle (only for end face Y/peripheral surface Y) The function must be set up by the machine manufacturer.	
Reference point 	Position of the reference point: <ul style="list-style-type: none"> •  (lefthand edge) •  (center) •  (righthand edge) 	
Machining 	<ul style="list-style-type: none"> • ▽ (roughing) • ▽▽ (pre-finishing) • ▽▽▽ (finishing) • ▽▽▽ base (base finishing) • ▽▽▽ edge (edge finishing) • Chamfering 	
Technology 	<ul style="list-style-type: none"> • Vortex milling The milling cutter performs circular motions along the length of the slot and back again. • Plunge cutting Sequential drilling motion along the tool axis. 	
	Milling direction: - (except plunge cutting) <ul style="list-style-type: none"> • Climbing • Conventional • Climbing-conventional milling 	
Machining position 	<ul style="list-style-type: none"> • Single position Mill a slot at the programmed position (X0, Y0, Z0). • Position pattern Mill slots at a programmed position pattern (e.g. full circle or grid). 	
X0 Y0 Z0 (only for G code)	The positions refer to the reference point: Reference point X – (only for single position) Reference point Y – (only for single position) Reference point Z – (only for single position)	mm mm mm



Parameter	Description	Unit
X0 or L0  Y0 or C0  Z0 (only for Shop-Turn)	Face C: The positions refer to the reference point: Reference point X or reference point length polar – (only for single position) Reference point Y or reference point angle polar – (only for single position) Reference point Z – (only for single position)	mm mm mm
CP X0 or L0  Y0 or C0  Z0 (only for Shop-Turn)	Face Y: The positions refer to the reference point: Positioning angle for machining area – (only single position) Angle CP does not have any effect on the machining position in relation to the workpiece. It is only used to position the workpiece with the rotary axis C in such a way that machining is possible on the machine. Reference point X or reference point length polar – (only for single position) Reference point Y or reference point angle polar - (only for single position) Reference point Z - (only for single position)	Degrees mm mm or de- grees mm
Y0 or C0  Z0 X0 (only for Shop-Turn)	Peripheral surface C: The positions refer to the reference point: Reference point Y or reference point angle polar - (only for single position) Reference point Z - (only for single position) Cylinder diameter \varnothing – (only for single position)	mm or de- grees mm mm
C0 Y0 Z0 X0 (only for Shop-Turn)	Peripheral surface Y: The positions refer to the reference point: Positioning angle for machining surface – (only for single position) Reference point Y – (only for single position) Reference point Z – (only for single position) Reference point X – (only for single position)	Degrees mm mm mm
W	Slot width	mm
L	Slot length	mm
$\alpha 0$	Angle of rotation of slot	Degrees
Z1  (only for G code)	Slot depth (abs) or depth relative to Z0 (abs) – (only for ∇ , $\nabla\nabla$, $\nabla\nabla$ base and $\nabla\nabla$)	mm
Z1 or X1  (only for Shop-Turn)	Slot depth (abs) or depth relative to Z0 or X0 (abs) – (only for ∇ , $\nabla\nabla$, $\nabla\nabla$ base and $\nabla\nabla$) (Z1 for machining surface, face C/Y or X1 for peripheral surface C/Y)	mm
DXY 	<ul style="list-style-type: none"> Maximum plane infeed Maximum plane infeed as a percentage of the milling cutter diameter - (only for ∇)	mm %
DZ	Maximum depth infeed - (only for ∇ , $\nabla\nabla$, $\nabla\nabla$ and $\nabla\nabla$ edge) - (only for vortex milling)	mm
UXY	Plane finishing allowance (slot edge) - (only for ∇ , $\nabla\nabla$ and $\nabla\nabla$ base)	mm
UZ	Depth finishing allowance (slot base) - (only for ∇ , $\nabla\nabla$ and $\nabla\nabla$ edge)	mm







10.4 Milling









Parameter	Description	Unit
FS	Chamfer width for chamfering (inc) - (for chamfering only)	mm
ZFS 	Insertion depth of tool tip (abs or inc) - (for chamfering only)	mm

* Unit of feedrate as programmed before the cycle call



Parameters in the "Input simple" mode

G code program parameters			ShopTurn program parameters		
Input 	• simple		T	Tool name	
RP	Retraction plane	mm	D	Cutting edge number	
F	Feedrate	*	F 	Feedrate	mm/min mm/rev
			S / V 	Spindle speed or constant cutting rate	rpm m/min

Parameter	Description	
Machining surface  (only for ShopTurn)	<ul style="list-style-type: none"> • Face C • Face Y • Peripheral surface C • Peripheral surface Y 	
Position  (only for ShopTurn)	<ul style="list-style-type: none"> • At the front (face) • At the rear (face) • Outside (peripheral surface) • Inside (peripheral surface) 	
  (only for ShopTurn)	Clamp/release spindle (only for end face Y/peripheral surface Y) The function must be set up by the machine manufacturer.	
Machining 	<ul style="list-style-type: none"> • ∇ (roughing) • ∇∇∇ (pre-finishing) • ∇∇∇ (finishing) • ∇∇∇ base (base finishing) • ∇∇∇ edge (edge finishing) • Chamfering 	
Technology 	<ul style="list-style-type: none"> • Vortex milling The milling cutter performs circular motions along the length of the slot and back again. • Plunge cutting Sequential drilling motion along the tool axis. 	

Parameter	Description	
	Milling direction - (except plunge cutting) <ul style="list-style-type: none"> • Climbing • Conventional • Climbing-conventional milling 	
X0 Y0 Z0 (only for G code)	The positions refer to the reference point: Reference point X Reference point Y Reference point Z	mm mm mm
X0 or L0  Y0 or C0  Z0 (only for ShopTurn)	Face C: The positions refer to the reference point: Reference point X or reference point length polar Reference point Y or reference point angle polar Reference point Z	mm mm or degrees mm
CP X0 or L0  Y0 or C0  Z0 (only for ShopTurn)	Face Y: The positions refer to the reference point: Positioning angle for machining area Angle CP does not have any effect on the machining position in relation to the workpiece. It is only used to position the workpiece with the rotary axis C in such a way that machining is possible on the machine. Reference point X or reference point length polar Reference point Y or reference point angle polar Reference point Z	Degrees mm mm or degrees mm
Y0 or C0  Z0 X0 (only for ShopTurn)	Peripheral surface C: The positions refer to the reference point: Reference point Y or reference point angle polar Reference point Z Cylinder diameter \varnothing	mm or degrees mm mm
C0 Y0 Z0 X0 (only for ShopTurn)	Peripheral surface Y: The positions refer to the reference point: Positioning angle for machining surface Reference point Y Reference point Z Reference point X	Degrees mm mm mm
W	Slot width	mm
L	Slot length	mm
Z1  (only for G code)	Slot depth (abs) or depth relative to Z0 (abs) – (only for ∇ , $\nabla\nabla$, $\nabla\nabla\nabla$ and $\nabla\nabla\nabla$ base)	mm
Z1 or X1  (only for G code)	Slot depth (abs) or depth relative to Z0 or X0 (abs) – (only for ∇ , $\nabla\nabla$, $\nabla\nabla\nabla$, $\nabla\nabla\nabla$ base) (Z1 for machining surface, face C/Y or X1 for peripheral surface C/Y)	mm

10.4 Milling

Parameter	Description	
DXY 	<ul style="list-style-type: none"> Maximum plane infeed Maximum plane infeed as a percentage of the milling cutter diameter- (only for ∇) 	mm %
DZ	Maximum depth infeed – (only for ∇, ∇∇, ∇∇∇ and ∇∇∇ edge) - (only for vortex milling)	mm
UXY	Plane finishing allowance (slot edge) - (only for ∇, ∇∇ and ∇∇∇ base)	mm
UZ	Depth finishing allowance (slot base) - (only for ∇, ∇∇ and ∇∇∇ edge)	mm
FS	Chamfer width for chamfering (inc) - (for chamfering only)	mm
ZFS 	Insertion depth of tool tip (abs or inc) - (for chamfering only)	mm

* Unit of feedrate as programmed before the cycle call

Hidden parameters

The following parameters are hidden. They are pre-assigned fixed values or values that can be adjusted using setting data.

Parameter	Description	Value	Can be set in SD
PL (only for G code)	Machining plane	Defined in MD 52005	
SC (only for G code)	Safety clearance	1 mm	x
Reference point	Position of the reference point: Center		
Machining position	Mill slot at the programmed position (X0, Y0, Z0).	Single position	
α0	Angle of rotation of slot	0°	



Machine manufacturer

Please refer to the machine manufacturer's specifications.

10.4.10 Long hole (LONGHOLE) - only for G code program

Function

In contrast to the groove, the width of the elongated hole is determined by the tool diameter. Internally in the cycle, an optimum traversing path of the tool is determined, ruling out unnecessary idle passes. If several depth infeeds are required to machine an elongated hole, the infeed is carried out alternately at the end points. The path to be traversed in the plane

along the longitudinal axis of the elongated hole changes its direction after each infeed. The cycle searches for the shortest path when changing to the next elongated hole.

Note

The cycle requires a milling cutter with a "face tooth cutting over center" (DIN 844).

Approach/retraction

1. Using G0, the starting position for the cycle is approached. In both axes of the current plane, the closest end point of the first elongated hole to be machined is approached at the level of the retraction plane in the tool axis and then lowered to the reference point shifted by the amount of the safety clearance.
2. Each elongated hole is milled in a reciprocating motion. The machining in the plane is performed using G1 and the programmed feedrate. At each reversal point, the infeed to the next machining depth calculated internally in the cycle is performed with G1 and the feedrate, until the final depth is reached.
3. Retraction to the retraction plane using G0 and approach to the next elongated hole on the shortest path.
4. After the last elongated hole has been machined, the tool at the position reached last in the machining plane is moved with G0 to the retraction plane, and the cycle terminated.





Procedure



1. The part program to be executed has been created and you are in the editor.
2. Press the "Milling" softkey.
3. Press the "Groove" and "Elongated hole" softkeys.
The "Elongated Hole" input window opens.

Parameter	Description	Unit
PL 	Machining plane	
RP	Retraction plane (abs)	
SC	Safety clearance (inc)	
F	Feedrate	*

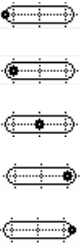
10.4 Milling

Parameter	Description	Unit
Machining type 	<ul style="list-style-type: none"> Plane-by-plane The tool is inserted to infeed depth in the pocket center. Note: This setting can be used only if the cutter can cut across center. Oscillating Insert with oscillation along center axis of longitudinal slot: The cutter center point oscillates along a linear path until it reaches the depth infeed. When the depth has been reached, the path is traversed again without depth infeed in order to eliminate the inclined insertion path. 	mm
Reference point 	Position of the reference point: 	
Machining position 	<ul style="list-style-type: none"> Single position An elongated hole is machined at the programmed position (X0, Y0, Z0). Position pattern Several elongated holes are machined in the programmed position pattern (e.g. pitch circle, grid, line). 	
X0	The positions refer to the reference point: Reference point X – (for single position only)	mm
Y0	Reference point Y – (for single position only)	mm
Z0	Reference point Z	mm
L	Elongated hole length	mm
$\alpha 0$	Angle of rotation	Degrees
Z1 	Elongated hole depth (abs) or depth in relation to Z0 (inc)	mm
DZ	Maximum depth infeed	mm
FZ	Depth infeed rate	*

* Unit of feedrate as programmed before the cycle call

10.4.11 Thread milling (CYCLE70)

Function

Using a thread cutter, internal or external threads can be machined with the same pitch. Threads can be machined as right-hand or left-hand threads and from top to bottom or vice versa.

For metric threads (thread pitch P in mm/rev), the cycle assigns a value (calculated on the basis of the thread pitch) to the thread depth H1 parameter. You can change this value. The default selection must be activated via a machine data code.



Machine manufacturer

Please refer to the machine manufacturer's specifications.

The entered feedrate acts on the workpiece contour, i.e. it refers to the thread diameter. However the feedrate of the cutter center point is displayed. That is why a smaller value is displayed for internal threads and a larger value is displayed for external threads than was entered.

Approach/retraction when milling internal threads

1. Positioning on retraction plane with rapid traverse.
2. Approach of starting point of the approach circle in the current plane with rapid traverse.
3. Infeed to a starting point in the tool axis calculated internally in the controller with rapid traverse.
4. Approach motion to thread diameter on an approach circle calculated internally in the controller with the programmed feedrate, taking into account the finishing allowance and maximum plane infeed.
5. Thread cutting along a spiral path in clockwise or counter-clockwise direction (depending on whether it is left-hand/right-hand thread, for number of cutting teeth of a milling plate $(NT) \geq 2$ only one rotation, offset in the Z direction).
To reach the programmed thread length, traversing is beyond the Z1 value for different distances depending on the thread parameters.
6. Exit motion along a circular path in the same rotational direction at programmed feedrate.
7. With a programmed number of threads per cutting edge $NT > 2$, the tool is fed in (offset) by the amount $NT-1$ in the Z direction. Points 4 to 7 are repeated until the programmed thread depth is reached.
8. If the plane infeed is less than the thread depth, points 3 to 7 are repeated until the thread depth + programmed allowance is reached.
9. Retract on the thread center point and then to retraction plane in the tool axis in rapid traverse.

Please note that when milling an internal thread the tool must not exceed the following value:

Milling cutter diameter $< (\text{nominal diameter} - 2 \cdot \text{thread depth H1})$

Approach/retraction when milling external threads

1. Positioning on retraction plane with rapid traverse.
2. Approach of starting point of the approach circle in the current plane with rapid traverse.
3. Infeed to a starting point in the tool axis calculated internally in the controller with rapid traverse.

10.4 Milling









4. Approach motion to thread core diameter on an approach circle calculated internally in the controller with the programmed feedrate, taking into account the finishing allowance and maximum plane infeed.
5. Cut thread along a spiral path in clockwise or counter-clockwise direction (depending on whether it is left-hand/right-hand thread, with $NT \geq 2$ only one rotation, offset in Z direction). To reach the programmed thread length, traversing is beyond the Z1 value for different distances depending on the thread parameters.
6. Exit motion along a circular path in opposite rotational direction at programmed feedrate.
7. With a programmed number of threads per cutting edge $NT > 2$, the tool is fed in (offset) by the amount $NT-1$ in the Z direction. Points 4 to 7 are repeated until the programmed thread depth is reached.
8. If the plane infeed is less than the thread depth, points 3 to 7 are repeated until the thread depth + programmed allowance is reached.
9. Retraction on the retraction plane in the tool axis with rapid traverse.

Procedure





1. The part program or ShopTurn program to be processed has been created and you are in the editor.
2. Press the "Milling" softkey.
3. Press the "Thread milling" softkey.
The "Thread Milling" input window opens.

Parameters, G code program			Parameters, ShopTurn program		
PL	Machining plane		T	Tool name	
	Milling direction		D	Cutting edge number	
RP	Retraction plane	mm	F	Feedrate	mm/min mm/rev
SC	Safety clearance	mm	S / V	Spindle speed or constant cutting rate	rpm m/min
F	Feedrate	mm/min			

Parameter	Description	Unit
Machining surface  (only for Shop-Turn)	<ul style="list-style-type: none"> • Face C • Face Y • Peripheral surface C • Peripheral surface Y 	
Position  (only for Shop-Turn)	<ul style="list-style-type: none"> • At the front (face) • At the rear (face) • Outside (peripheral surface) • Inside (peripheral surface) 	
  (only for Shop-Turn)	Clamp/release spindle (only for end face Y/peripheral surface Y) The function must be set up by the machine manufacturer.	
Machining	<ul style="list-style-type: none"> • ▽ (roughing) • ▽▽▽ (finishing) 	
	Machining direction: <ul style="list-style-type: none"> • Z0 → Z1 Machining from top to bottom • Z1 → Z0 Machining from bottom to top 	
	Direction of rotation of the thread: <ul style="list-style-type: none"> • Right-hand thread A right-hand thread is cut. • Left-hand thread A left-hand thread is cut. 	
	Position of the thread: <ul style="list-style-type: none"> • Internal thread An internal thread is cut. • External thread An external thread is cut. 	
NT	Number of teeth per cutting edge Single or multiple toothed milling inserts can be used. The motions required are executed by the cycle internally, so that the tip of the bottom tooth on the milling tool cutting edge corresponds to the programmed end position when the thread end position is reached. Depending on the cutting edge geometry of the milling insert, the retraction path must be taken into account at the base of the workpiece.	
 (only for G code)	Machining position: <ul style="list-style-type: none"> • Single position • Position pattern (MCALL) 	

10.4 Milling

Parameter	Description	Unit
X0 Y0 Z0 (only for G code)	The positions refer to the center point: Reference point X – (only for single position) Reference point Y – (only for single position) Reference point Z	mm mm mm
Z1 	End point of the thread (abs) or thread length (inc)	mm
Table 	Thread table selection: <ul style="list-style-type: none"> Without ISO metric Whitworth BSW Whitworth BSP UNC 	
Selection - (not for table "without")	Selection, table value: e.g. <ul style="list-style-type: none"> M3; M10; etc. (ISO metric) W3/4"; etc. (Whitworth BSW) G3/4"; etc. (Whitworth BSP) N1" - 8 UNC; etc. (UNC) 	
P	Display of the thread pitch for the parameter input in the input field "Table" and "Selection".	MODULUS turns/" mm/rev in/rev
P  - (selection option only for table selection "without")	Pitch ... <ul style="list-style-type: none"> In MODULUS: For example, generally used for worm gears that mesh with a gear wheel. Per inch: Used with pipe threads, for example. When entered per inch, enter the integer number in front of the decimal point in the first parameter field and the figures after the decimal point as a fraction in the second and third field. In mm/rev In inch/rev The tool used depends on the thread pitch.	MODULUS Turns/" mm/rev in/rev
∅	Nominal diameter Example: Nominal diameter of M12 = 12 mm	mm
H1	Thread depth	mm
DXY	Maximum plane infeed	mm
rev	Finishing allowance in X and Y - (only for ▽)	mm
αS	Starting angle	Degrees

10.4.12 Engraving (CYCLE60)

Function

The "Engraving" function is used to engrave a text on a workpiece along a line or arc.

You can enter the text directly in the text field as "fixed text" or assign it via a variable as "variable text".

Engraving uses a proportional font, i.e., the individual characters are of different widths.

Approach/retraction

1. The tool approaches the starting point at rapid traverse at the height of the retraction plane and adjusts to the safety clearance.
2. The tool moves to the machining depth FZ at the infeed feedrate Z1 and mills the characters.
3. The tool retracts to the safety clearance at rapid traverse and moves along a straight line to the next character.
4. Steps 2 and 3 are repeated until the entire text has been milled.
5. The tool moves to the retraction plane in rapid traverse.

Procedure











1. The part program or ShopTurn program to be processed has been created and you are in the editor.
2. Press the "Milling" softkey.
3. Press the "Engraving" softkey.
The "Engraving" input window opens.

Entering the engraving text

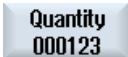

4. Press the "Special characters" softkey if you need a character that does not appear on the input keys.
The "Special characters" window appears.
 - Position the cursor on the desired character.
 - Press the "OK" softkey.
 The selected character is inserted into the text at the cursor position.
5. If you wish to delete the complete text, press the "Delete text" and "Delete" softkeys one after the other.
6. Press the "Lowercase" softkey to enter lowercase letters. Press it again to enter uppercase letters.

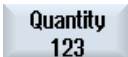
10.4 Milling

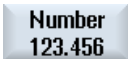
- | | |
|--|---|
| 
 | <p>7. Press the "Variable" and "Date" softkeys if you want to engrave the current date.</p> <p>The data is inserted in the European date format (<DD>.<MM>.<YYYY>). To obtain a different date format, you must adapt the format specified in the text field. For example, to engrave the date in the American date format (month/day/year => 8/16/04), change the format to <M>/<D>/<YY> .</p> |
| 
 | <p>7. Press the "Variable" and "Time" softkeys if you want to engrave the current time.</p> <p>The time is inserted in the European format (<TIME24>). To have the time in the American format, change the format to <TIME12>.</p> <p>Example:
 Text entry: Time: <TIME24> Execute: Time: 16.35
 Time: <TIME12> Execute: Time: 04.35 PM</p> |
| 
 | <p>7. • Press the "Variable" and "Workpiece count 000123" softkeys to engrave a workpiece count with a fixed number of digits and leading zeroes.</p> <p>The format text <#####,_\$AC_ACTUAL_PARTS> is inserted and you return to the engraving field with the softkey bar.</p> <p>• Define the number of digits by adjusting the number of place holders (#) in the engraving field.</p> <p>If the specified number of positions (e.g. ##) is not sufficient to represent the unit quantity, then the cycle automatically increases the number of positions.</p> <p>- OR</p> |
| 
 | <p>7. • Press the "Variable" and "Workpiece count 123" softkeys if you want to engrave a workpiece count without leading zeroes.</p> <p>The format text <#,_\$AC_ACTUAL_PARTS> is inserted and you return to the engraving field with the softkey bar.</p> <p>• Define the number of digits by adjusting the number of place holders in the engraving field.</p> <p>If the specified number of digits is not enough to display the workpiece count (e.g. 123), the cycle will automatically increase the number digits.</p> |
| 
 | <p>7. • Press the "Variable" and "Number 123.456" softkeys if you want to engrave a any number in a certain format.</p> <p>The format text <#.###,_VAR_NUM> is inserted and you return to the engraving field with the softkey bar.</p> <p>• The place holders #.### define the digit format in which the number defined in _VAR_NUM will be engraved.</p> <p>For example, if you have stored 12.35 in _VAR_NUM, you can format the variable as follows.</p> |

Input	Output	Meaning
-------	--------	---------

<#,_VAR_NUM>	12	Places before decimal point unformatted, no places after the decimal point
<####,_VAR_NUM>	0012	4 places before decimal point, leading zeros, no places after the decimal point
<#,_VAR_NUM>	12	4 places before decimal point, leading blanks, no places after the decimal point
<#.,_VAR_NUM>	12.35	Places before and after the decimal point not formatted.
<#.#,_VAR_NUM>	12.4	Places before decimal point unformatted, 1 place after the decimal point (rounded)
<#.##_VAR_NUM>	12.35	Places before decimal point unformatted, 2 places after the decimal point (rounded)
<#.####,_VAR_NUM>	12.3500	Places before decimal point unformatted, 4 places after the decimal point (rounded)

If there is insufficient space in front of the decimal point to display the number entered, it is automatically extended. If the specified number of digits is larger than the number to be engraved, the output format is automatically filled with the appropriate number of leading and trailing zeroes.

You can optionally use blanks to format before the decimal place.

Instead of _VAR_NUM you can use any other numeric variable (e.g. R0).



7. Press the "Variable" and "Variable text" softkeys if you want to take the text to be engraved (up to 200 characters) from a variable.



The format text <Text, _VAR_TEXT> is inserted and you return to the engraving field with the softkey bar.

You can use any other text variable instead of _VAR_TEXT.

Note

Entering the engraving text

Only single-line entries without line break are permissible!

Variable texts

There are various ways of defining variable text:

- Date and time
For example, you can engrave the time and date of manufacture on a workpiece. The values for date and time are read from the NCK.
- Quantity

Using the workpiece variables you can assign a consecutive number to the workpieces. You can define the format (number of digits, leading zeroes). The place holder (#) is used to format the number of digits at which the workpiece counts output will begin. If you do not want to output a count of 1 for the first workpiece, you can specify an additive value (e.g., <#,\$AC_ACTUAL_PARTS + 100>). The workpiece count output is then incremented by this value (e. g. 101, 102, 103,...).

- Numbers

When outputting number (e. g. measurement results), you can select the output format (digits either side of the point) of the number to be engraved.

- Text





Instead of entering a fixed text in the engraving text field, you can specify the text to be engraved via a text variable (e. g., _VAR_TEXT="ABC123").





















Mirror writing

You can engrave the text mirrored on the workpiece.











Full circle

If you want to distribute the characters evenly around a full circle, enter the arc angle $\alpha_2=360^\circ$. The cycle then distributes the characters evenly around the full circle.

Parameters, G code program			Parameters, ShopTurn program		
PL	Machining plane		T	Tool name	
					
	Milling direction		D	Cutting edge number	
RP	Retraction plane	mm	F	Feedrate	mm/min mm/tooth
					
SC	Safety clearance	mm	S / V	Spindle speed or constant cutting rate	rpm m/min
					
F	Feedrate	mm/min			

Parameter	Description	Unit
FZ (only for G code)	Depth infeed rate	*
FZ  (only for Shop-Turn)	Depth infeed rate	mm/min mm/tooth
Machining surface  (only for Shop-Turn)	<ul style="list-style-type: none"> • Face C • Face Y • Peripheral surface C • Peripheral surface Y 	
Position  (only for Shop-Turn)	<ul style="list-style-type: none"> • At the front (face) • At the rear (face) • Outside (peripheral surface) • Inside (peripheral surface) 	
  (only for Shop-Turn)	Clamp/release spindle (only for end face Y/peripheral surface Y) The function must be set up by the machine manufacturer.	
Alignment 	<ul style="list-style-type: none"> •  (linear alignment) •  (curved alignment) •  (curved alignment) 	
Reference point 	Position of the reference point <ul style="list-style-type: none"> •  bottom left •  bottom center •  bottom right •  top left •  top center •  top right •  left-hand edge •  center •  right-hand edge 	
Mirror writing	<ul style="list-style-type: none"> • Yes The mirrored text is engraved on the workpiece. • No The text is engraved on the workpiece without mirroring. 	
Engraving text	maximum 100 characters	
X0 or R  Y0 or α0 	The positions refer to the reference point: Reference point X or reference point length polar Reference point Y or reference point angle polar	mm mm or de- grees
Z0 (only for G code)	Reference point Z	mm

10.4 Milling

Parameter	Description	Unit
X0 or L0  Y0 or C0  Z0 (only ShopTurn)	Face C: The positions refer to the reference point: Reference point X or reference point length polar Reference point Y or reference point angle polar Reference point Z	mm mm or de- grees mm
CP X0 or L0  Y0 or C0  Z0 (only ShopTurn)	Face Y: The positions refer to the reference point: Positioning angle for machining area Angle CP does not have any effect on the machining position in relation to the workpiece. It is only used to position the workpiece with the rotary axis C in such a way that machining is possible on the machine. Reference point X or reference point length polar Reference point Y or reference point polar angle Reference point Z	Degrees mm mm or de- grees mm
Y0 or C0  Z0 X0 (only ShopTurn)	Peripheral surface C: The positions refer to the reference point: Reference point Y or reference point angle polar – (only for single position) Reference point Z Cylinder diameter \varnothing	mm or de- grees mm mm
C0 Y0 Z0 X0 (only ShopTurn)	Peripheral surface Y: The positions refer to the reference point: Positioning angle for machining surface – (only for single position) Reference point Y Reference point Z Reference point X	Degrees mm mm mm
Z1 	Engraving depth (abs) or referenced depth (inc)	mm
W	Character height	mm
DX1 or $\alpha 2$ 	Distance between characters or angle of opening – (for curved alignment only)	mm or Degrees
DX1 or DX2 	Distance between characters or total width – (for linear alignment only)	mm
$\alpha 1$	Text direction (for linear alignment only)	Degrees
XM or LM  (only G code)	Center point X (abs) or center point length polar – (for curved alignment only)	mm
YM or αM  (only G code)	Center point Y (abs) or center point angle polar – (for curved alignment only)	mm
YM or CM  (only ShopTurn)	Center point Y or C (abs.) – (for curved alignment only) - (only for machining surface, peripheral surface C/Y)	mm or de- grees
ZM (only ShopTurn)	Center point Z (abs.) – (for curved alignment only) - (only for machining surface, peripheral surface C/Y)	mm

* Unit of feedrate as programmed before the cycle call

10.5 Contour milling

10.5.1 General information

Function

You can mill simple or complex contours with the "Contour milling" cycle. You can define open contours or closed contours (pockets, islands, spigots).

A contour comprises separate contour elements, whereby at least two and up to 250 elements result in a defined contour. Radii, chamfers and tangential transitions are available as contour transition elements.

The integrated contour calculator calculates the intersection points of the individual contour elements taking into account the geometrical relationships, which allows you to enter incompletely dimensioned elements.

With contour milling, you must always program the geometry of the contour before you program the technology.

10.5.2 Representation of the contour

G code program





In the editor, the contour is represented in a program section using individual program blocks. If you open an individual block, then the contour is opened.





ShopTurn program

The cycle represents a contour as a program block in the program. If you open this block, the individual contour elements are listed symbolically and displayed in broken-line graphics.

Symbolic representation

The individual contour elements are represented by symbols adjacent to the graphics window. They appear in the order in which they were entered.

Contour element	Symbol	Meaning
Starting point		Starting point of the contour
Straight line up		Straight line in 90° grid
Straight line down		Straight line in 90° grid
Straight line left		Straight line in 90° grid

Contour element	Symbol	Meaning
Straight line right		Straight line in 90° grid
Straight line in any direction		Straight line with any gradient
Arc right		Circle
Arc left		Circle
Pole		Straight diagonal or circle in polar coordinates
Finish contour	END	End of contour definition

The different colors of the symbols indicate their status:

Foreground	Background	Meaning
Black	Blue	Cursor on active element
Black	Orange	Cursor on current element
Black	White	Normal element
Red	White	Element not currently evaluated (element will only be evaluated when it is selected with the cursor)

Graphic display

The progress of contour programming is shown in broken-line graphics while the contour elements are being entered.

When the contour element has been created, it can be displayed in different line styles and colors:

- Black: Programmed contour
- Orange: Current contour element
- Green dashed: Alternative element
- Blue dotted: Partially defined element

The scaling of the coordinate system is adjusted automatically to match the complete contour.

The position of the coordinate system is displayed in the graphics window.

10.5.3 Creating a new contour

Function

For each contour that you want to mill, you must create a new contour.

The contours are stored at the end of the program.

Note

When programming in the G code, it must be ensured that the contours are located after the end of program identifier!

The first step in creating a contour is to specify a starting point. Enter the contour element. The contour processor then automatically defines the end of the contour.

If you alter the tool axis, the cycle will automatically adjust the associated starting point axes. You can enter any additional commands (up to 40 characters) in G code format for the starting point.

Additional commands

You can program feedrates and M commands, for example, using additional G code commands. You can enter the additional commands (max. 40 characters) in the extended parameter screens ("All parameters" softkey). However, make sure that the additional commands do not collide with the generated G code of the contour. Therefore, do not use any G code commands of group 1 (G0, G1, G2, G3), no coordinates in the plane and no G code commands that have to be programmed in a separate block.

Procedure



1. The part program or ShopTurn program to be processed has been created and you are in the editor.
2. Press the "Milling" softkey.
3. Press the "Contour milling" and "New contour" softkeys. The "New Contour" input window opens.
4. Enter a contour name.
5. Press the "Accept" softkey. The input screen for the starting point of the contour appears. You can enter Cartesian or polar coordinates.

Cartesian starting point



1. Enter the starting point for the contour.
2. Enter any additional commands in G code format, as required.
3. Press the "Accept" softkey.
4. Enter the individual contour elements.



Polar starting point



1. Press the "Pole" softkey.
2. Enter the pole position in Cartesian coordinates.
3. Enter the starting point for the contour in polar coordinates.
4. Enter any additional commands in G code format, as required.



5. Press the "Accept" softkey.
6. Enter the individual contour elements.

parameters		Description	Unit
Machining surface  (only for ShopTurn)		<ul style="list-style-type: none"> • Face C • Face Y • Face B • Peripheral surface C • Peripheral surface Y 	
PL  (only for G code)		Machining plane <ul style="list-style-type: none"> • G17 (XY) • G19 (YZ) 	
ϕ (only ShopTurn)		Cylinder diameter (only peripheral surface C)	mm
G17 or face C/Y/B	G19 or peripheral surface C/Y		
X	Y	Cartesian: Starting point X or Y (abs)	mm
Y	Z	Starting point Y or Z (abs)	mm
X	Y	Polar: Position pole (abs)	mm
Y	Z	Position pole (abs)	mm

parameters	Description	Unit
Starting point		
L1	Distance to pole, end point (abs)	mm
$\phi 1$	Polar angle to the pole, end point (abs)	Degrees
Additional commands	<p>You can program feedrates and M commands, for example, using additional G code commands. However, carefully ensure that the additional commands do not collide with the generated G code of the contour and are compatible with the machining type required. Therefore, do not use any G code commands of group 1 (G0, G1, G2, G3), no coordinates in the plane and no G code commands that have to be programmed in a separate block.</p> <p>The contour is finished in continuous-path mode (G64). As a result, contour transitions such as corners, chamfers or radii may not be machined precisely.</p> <p>If you wish to avoid this, then it is possible to use additional commands when programming.</p> <p>Example: For a contour, first program the straight X parallel and then enter "G9" (non-modal exact stop) for the additional command parameter. Then program the Y-parallel straight line. The corner will be machined exactly, as the feedrate at the end of the X-parallel straight line is briefly zero.</p> <p>Note: The additional commands are only effective for path milling!</p>	

10.5.4 Creating contour elements

After you have created a new contour and specified the starting point, you can define the individual elements that make up the contour.

The following contour elements are available for the definition of a contour:

- Straight vertical line
- Straight horizontal line
- Diagonal line
- Circle/arc
- Pole

For each contour element, you must parameterize a separate parameter screen.

The coordinates for a horizontal or vertical line are entered in Cartesian format; however, for the contour elements Diagonal line and Circle/arc you can choose between Cartesian and polar coordinates. If you wish to enter polar coordinates you must first define a pole. If you have already defined a pole for the starting point, you can also refer the polar coordinates to this pole. Therefore, in this case, you do not have to define an additional pole.

Cylinder surface transformation

For contours (e.g. slots) on cylinders, lengths are frequently specified in the form of angles. If the "Cylinder surface transformation" function is activated, you can also define on a cylinder the length of contours (in the circumferential direction of the cylinder surface) using angles. This means instead of X, Y and I, J, you enter $X\alpha$, $Y\alpha$ and $I\alpha$, $J\alpha$.



Machine manufacturer

Please refer to the machine manufacturer's specifications.

Parameter input

Parameter entry is supported by various help screens that explain the parameters.

If you leave certain fields blank, the geometry processor assumes that the values are unknown and attempts to calculate them from other parameters.

Conflicts may result if you enter more parameters than are absolutely necessary for a contour. In such a case, try to enter fewer parameters and allow the geometry processor to calculate as many parameters as possible.

Contour transition elements

As a transition between two contour elements, you can choose a radius or a chamfer. The transition element is always attached at the end of a contour element. The contour transition element is selected in the parameter screen of the respective contour element.

You can use a contour transition element whenever there is an intersection between two successive elements which can be calculated from the input values. Otherwise you must use the straight/circle contour elements.

The contour end is an exception. Although there is no intersection to another element, you can still define a radius or a chamfer as a transition element for the blank.

Additional functions

The following additional functions are available for programming a contour:

- Tangent to preceding element
You can program the transition to the preceding element as tangent.
- Dialog box selection

If two different possible contours result from the parameters entered thus far, one of the options must be selected.

- Close contour
From the actual position, you can close the contour with a straight line to the starting point.

Procedure for entering or changing contour elements

1. The part program or ShopTurn program to be executed is created.
2. Select the file type (MPF or SPF), enter the desired name of the program and press the "OK" softkey or the "Input" key.
This editor is opened.
3. Select a contour element via softkey.
The input window "Straight (e.g. X)" opens.

- OR
The input window "Straight (e.g. Y)" opens.

- OR
The input window "Straight (e.g. XY)" opens.

- OR
The "Circle" input window opens.

- OR
The "Pole Input" input window opens.
4. Enter all the data available from the workpiece drawing in the input screen (e.g. length of straight line, target position, transition to next element, angle of lead, etc.).
5. Press the "Accept" softkey.
The contour element is added to the contour.
6. When entering data for a contour element, you can program the transition to the preceding element as a tangent.
Press the "Tangent to prec. elem." softkey. The angle to the preceding element α_2 is set to 0° . The "tangential" selection appears in the parameter input field.
7. Repeat the procedure until the contour is complete.
8. Press the "Accept" softkey.
The programmed contour is transferred to the machining plan (program view).
9. If you want to display further parameters for certain contour elements, e.g. to enter additional commands, press the "All parameters" softkey.







Contour element "Straight line, e.g. X"

Parameters	Description	Unit
Machining surface U (only for ShopTurn)	<ul style="list-style-type: none"> • Face C • Face Y • Face B • Peripheral surface C • Peripheral surface Y 	
X U	End point X (abs or inc)	mm
$\alpha 1$	Starting angle e.g. to the X axis	Degrees
$\alpha 2$	Angle to the preceding element	Degrees
Transition to next element U	Type of transition <ul style="list-style-type: none"> • Radius • Chamfer 	
Radius	R Transition to following element - radius	mm
Chamfer	FS Transition to following element - chamfer	mm
Additional commands	Additional G code commands	









Contour element "straight line, e.g. Y"

Parameters	Description	Unit
Machining surface U (only for ShopTurn)	<ul style="list-style-type: none"> • Face C • Face Y • Face B • Peripheral surface C • Peripheral surface Y 	
Y U	End point Y (abs or inc)	mm
$\alpha 1$	Starting angle to X axis	Degrees
Transition to next element U	Type of transition <ul style="list-style-type: none"> • Radius • Chamfer 	
Radius	R Transition to following element - radius	mm
Chamfer	FS Transition to following element - chamfer	mm
Additional commands	Additional G code commands	

Contour element "Straight line e.g. XY"

Parameters	Description	Unit
Machining surface  (only for ShopTurn)	<ul style="list-style-type: none"> • Face C • Face Y • Face B • Peripheral surface C • Peripheral surface Y 	
X 	End point X (abs or inc)	mm
Y 	End point Y (abs or inc)	mm
L	Length	mm
α_1	Starting angle e.g. to the X axis	Degrees
α_2	Angle to the preceding element	Degrees
Transition to next element 	Type of transition <ul style="list-style-type: none"> • Radius • Chamfer 	
Radius	R Transition to following element - radius	mm
Chamfer	FS Transition to following element - chamfer	mm
Additional commands	Additional G code commands	

Contour element "Circle"

Parameters	Description	Unit
Machining surface  (only for ShopTurn)	<ul style="list-style-type: none"> • Face C • Face Y • Face B • Peripheral surface C • Peripheral surface Y 	
Direction of rotation 	<ul style="list-style-type: none"> • Clockwise direction of rotation  • Counterclockwise direction of rotation  	
R	Radius	mm
e.g. X 	End point X (abs or inc)	mm
e.g. Y 	End point Y (abs or inc)	mm
e.g. I 	Circle center point I (abs or inc)	mm
e.g. J 	Circle center point J (abs or inc)	mm
α_1	Starting angle to X axis	Degrees
α_2	Angle to the preceding element	Degrees
β_1	End angle to Z axis	Degrees
β_2	Opening angle	Degrees

10.5 Contour milling

Parameters	Description	Unit
Transition to next element 	Type of transition <ul style="list-style-type: none"> • Radius • Chamfer 	
Radius	R Transition to following element - radius	mm
Chamfer	FS Transition to following element - chamfer	mm
Additional commands	Additional G code commands	

Contour element "Pole"

Parameters	Description	Unit
Machining surface  (only for ShopTurn)	<ul style="list-style-type: none"> • Face C • Face Y • Face B • Peripheral surface C • Peripheral surface Y 	
X	Position pole (abs)	mm (in)
Y	Position pole (abs)	Degrees

Contour element "End"

The data for the transition at the contour end of the previous contour element is displayed in the "End" parameter screen.
 The values cannot be edited.

10.5.5 Changing the contour

Function

You can change a previously created contour later.
 If you want to create a contour that is similar to an existing contour, you can copy the existing one, rename it and just alter selected contour elements.

Individual contour elements can be

- added,
- changed,
- inserted or
- deleted.

Procedure for changing a contour element

1. Open the part program or ShopTurn program to be executed.
2. With the cursor, select the program block where you want to change the contour. Open the geometry processor.
The individual contour elements are listed.
3. Position the cursor at the position where a contour element is to be inserted or changed.
4. Select the desired contour element with the cursor.
5. Enter the parameters in the input screen or delete the element and select a new element.
6. Press the "Accept" softkey.
The desired contour element is inserted in the contour or changed.



Procedure for deleting a contour element

1. Open the part program or ShopTurn program to be executed.
2. Position the cursor on the contour element that you want to delete.
3. Press the "Delete element" softkey.
4. Press the "Delete" softkey.



10.5.6 Contour call (CYCLE62) - only for G code program

Function

The input creates a reference to the selected contour.

There are four ways to call the contour:

1. Contour name
The contour is in the calling main program.
2. Labels
The contour is in the calling main program and is limited by the labels that have been entered.
3. Subprogram
The contour is located in a subprogram in the same workpiece.
4. Labels in the subprogram
The contour is in a subprogram and is limited by the labels that have been entered.

Procedure



1. The part program or ShopTurn program to be processed has been created and you are in the editor.
2. Press the "Milling" and "Contour milling" softkeys.
3. Press the "Contour" and "Contour call" softkeys. The "Contour Call" input window opens.
4. Assign parameters to the contour selection.

Parameter	Description	Unit
Contour selection 	<ul style="list-style-type: none"> • Contour name • Labels • Subprogram • Labels in the subprogram 	
Contour name	CON: Contour name	
Labels	<ul style="list-style-type: none"> • LAB1: Label 1 • LAB2: Label 2 	
Subprogram	PRG: Subprogram	
Labels in the subprogram	<ul style="list-style-type: none"> • PRG: Subprogram • LAB1: Label 1 • LAB2: Label 2 	

Note

EXTCALL / EES

When calling a part program via EXTCALL without EES, the contour can only be called via "Contour name" and/or "Labels". This is monitored in the cycle, which means that contour calls via "subprogram" or "labels in subprogram" are only possible if EES is active.

10.5.7 Path milling (CYCLE72)

Function

You can mill along any programmed contour with the "Path milling" cycle. The function operates with cutter radius compensation. You can machine in either direction, i.e. in the direction of the programmed contour or in the opposite direction.

For machining in the opposite direction, contours must not consist of more than 170 contour elements (incl. chamfers/radii). Special aspects (except for feed values) of free G code input are ignored during path milling in the opposite direction to the contour.

Note**Activating G40**

Before calling the cycle, we recommend that G40 is activated.

Clamping the spindle

For ShopTurn, the "Clamp spindle" function can be set up by the machine manufacturer.

**Machine manufacturer**

Please refer to the machine manufacturer's instructions.

See also

Clamping the spindle (Page 293)

Programming of arbitrary contours

The machining of arbitrary open or closed contours is generally programmed as follows:

1. Enter contour
You build up the contour gradually from a series of different contour elements. Define the contour in a subprogram or in the machining program, e.g. after the end of program (M02 or M30).
2. Contour call (CYCLE62)
You select the contour to be machined.
3. Path milling (roughing)
The contour is machined taking into account various approach and retract strategies.
4. Path milling (finishing)
If you programmed a finishing allowance for roughing, the contour is machined again.
5. Path milling (chamfering)
If you have planned edge breaking, chamfer the workpiece with a special tool.

Path milling on right or left of the contour

A programmed contour can be machined with the cutter radius compensation to the right or left. You can also select various modes and strategies of approach and retraction from the contour.

Approach/retraction mode

The tool can approach or retract from the contour along a quadrant, semi-circle or straight line.

- With a quadrant or semi-circle, you must specify the radius of the cutter center point path.
- With a straight line, you must specify the distance between the cutter outer edge and the contour starting or end point.

You can also program a mixture of modes, e.g. approach along quadrant, retract along semi-circle.

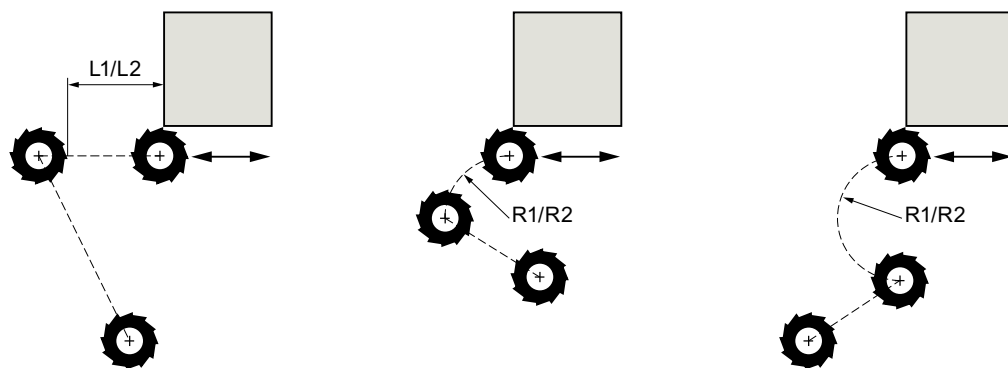

- L1 Approach length
- L2 Retraction length
- R1 Approach radius
- R2 Retraction radius

Figure 10-18 Approach and retraction along straight line, quadrant and semi-circle

Approach/retraction strategy

You can choose between planar approach/retraction and spatial approach/retraction:

- Planar approach:
Approach is first at depth and then in the machining plane.
- Spatial approach:
Approach is at depth and in machining plane simultaneously.
- Retraction is performed in reverse order.
Mixed programming is possible, for example, approach in the machining plane, retract spatially.

Path milling along center-point path.

A programmed contour can also be machined along the center-point path if the radius correction was switched-out. In this case, approaching and retraction is only possible along a straight line or vertical. Vertical approach/retraction can be used for closed contours, for example.

Machining type

You can select the machining mode (roughing, finishing, or chamfer) for path milling. If you want to "rough" and then "finish", you have to call the machining cycle twice (Block 1 = roughing, Block 2 = finishing). The programmed parameters are retained when the cycle is called for the second time.

It is also possible to choose between machining the contour with a cutter radius offset or traversing on the center-point path.

Slot side compensation

When you mill a contour on the peripheral surface (peripheral machining surface C), you can work with or without a slot wall compensation.

- Slot side compensation off
ShopTurn creates slots with parallel walls when the tool diameter is equal to the slot width. If the slot width is larger than the tool diameter, the slot walls will not be parallel.
- Slot side compensation on
ShopTurn creates slots with parallel walls also when the slot width is larger than the tool diameter. If you want to work with a slot wall compensation, you must not program the contour of the slot, but instead the imagined center path of a bolt inserted in the slot whereby the bolt touches both walls. Parameter D is used to specify the slot width.

Note



When working with slot side compensation, you have to program the path from the starting point to the end point and the path from the end point to the starting point.







Procedure











1. The part program or ShopTurn program to be processed has been created and you are in the editor.
2. Press the "Milling" softkey.
3. Press the "Contour milling" and "Path milling" softkeys. The "Path Milling" input window opens.







10.5 Contour milling

Parameters, G code program			Parameters, ShopTurn program		
PL 	Machining plane		T	Tool name	
RP	Retraction plane	mm	D	Cutting edge number	
SC	Safety clearance	mm	F 	Feedrate	mm/min mm/tooth
F	Feedrate	*	S / V 	Spindle speed or constant cutting rate	rpm m/min

Parameter	Description	Unit
Machining surface  (only for Shop-Turn)	<ul style="list-style-type: none"> • Face C • Face Y • Peripheral surface C • Peripheral surface Y 	
Position  (only for Shop-Turn)	<ul style="list-style-type: none"> • At the front (face) • At the rear (face) • Outside (peripheral surface) • Inside (peripheral surface) 	
  (only for Shop-Turn)	Clamp/release spindle (only for end face Y/peripheral surface Y) The function must be set up by the machine manufacturer.	
Machining 	<ul style="list-style-type: none"> • ▽ (roughing) • ▽▽▽ (finishing) • Chamfering 	
Machining direction 	Machining in the programmed contour direction <ul style="list-style-type: none"> • Forward: Machining is performed in the programmed contour direction • Backward: Machining is performed in the opposite direction to the programmed contour 	

Parameter	Description	Unit
Radius compensation 	<ul style="list-style-type: none"> Left (machining to the left of the contour)  Right (machining to the right of the contour)  off  <p>A programmed contour can also be machined on the center-point path. In this case, approaching and retraction is only possible along a straight line or vertical. Vertical approach/retraction can be used for closed contours, for example.</p>	
Slot side compensation  (only ShopTurn)	Slot side compensation on or off (only for machining surface, peripheral surface C)	
D	Offset to programmed path - (only for slot side compensation on)	
CP	Positioning angle for machining area - (only for ShopTurn, machining surface, face Y) Angle CP does not have any effect on the machining position in relation to the workpiece. It is only used to position the workpiece with the rotary axis C in such a way that machining is possible on the machine.	Degrees
C0	Positioning angle for machining surface - (only for ShopTurn, machining surface, peripheral surface Y)	Degrees
Z0	Reference point Z	mm
Z1	Final drilling depth (abs) or final drilling depth referred to Z0 or X0 (inc)	mm
DZ	Maximum depth infeed - (only for machining ▽ and ▽▽▽)	mm
UZ	Depth finishing allowance - (only for machining ▽)	mm
UXY	Finishing allowance, plane	mm
Approach 	Planar approach mode: <ul style="list-style-type: none"> Quadrant: Part of a spiral (only with path milling left and right of the contour) Semi-circle: Part of a spiral (only with path milling left and right of the contour) Straight line: Slope in space Perpendicular: Perpendicular to the path (only with path milling on the center-point path) 	
Approach strategy 	<ul style="list-style-type: none"> axis-by-axis - (only for "quadrant, semi-circle or straight line" approach)  spatial - (only for "quadrant, semi-circle or straight line" approach)  	

10.5 Contour milling

Parameter	Description	Unit
R1	Approach radius - (only for "quadrant or semi-circle" approach)	mm
L1	Approach distance - (only for "straight line" approach)	mm
FZ (only for G code)	Depth infeed rate	*
FZ (only for Shop-Turn)	Depth infeed rate	mm/min mm/tooth
Retraction 	Planar retraction mode: <ul style="list-style-type: none"> • Quadrant: Part of a spiral (only with path milling left and right of the contour) • Semi-circle: Part of a spiral (only with path milling left and right of the contour) • Straight line: 	
Retraction strategy 	<ul style="list-style-type: none"> • axis-by-axis  • spatial  	
R2	Retraction radius - (only for "quadrant or semi-circle" retraction)	mm
L2	Retraction distance - (only for "straight line" retraction)	mm
Lift mode 	If more than one depth infeed is necessary, specify the retraction height to which the tool retracts between the individual infeeds (at the transition from the end of the contour to the start). Lift mode before new infeed <ul style="list-style-type: none"> • No retraction • to RP • Z0 + safety clearance • By the safety clearance 	
FS	Chamfer width for chamfering - (only for chamfering machining)	mm
ZFS 	Insertion depth of tool tip (abs or inc) - (for chamfering machining only)	mm

* Unit of feedrate as programmed before the cycle call

10.5.8 Contour pocket/contour spigot (CYCLE63/64)

Contours for pockets or islands

Contours for pockets or islands must be closed, i.e. the starting point and end point of the contour are identical. You can also mill pockets that contain one or more islands. The islands can also be located partially outside the pocket or overlap each other. The first contour you specify is interpreted as the pocket contour and all the others as islands.

Automatic calculation / manual input of the starting point

Using "Automatic starting point" you have the option of calculating the optimum plunge point.

By selecting "Manual starting point", you define the plunge point in the parameter screen.

If the islands and the miller diameter, which must be plunged at various locations, are obtained from the pocket contour, then the manual entry only defines the first plunge point; the remaining plunge points are automatically calculated.

Contours for spigots

Contours for spigots must be closed, i.e. the starting point and end point of the contour are identical. You can define multiple spigots that can also overlap. The first contour specified is interpreted as a blank contour and all others as spigots.

Machining

You program the machining of contour pockets with islands/blank contour with spigots, e.g. as follows:

1. Enter the pocket contour/blank contour
2. Enter the island/spigot contour
3. Call the contour for pocket contour/blank contour or island/spigot contour (only for G code program)
4. Center (this is only possible for pocket contour)
5. Predrill (this is only possible for pocket contour)
6. Solid machine/machine pocket / spigot - roughing
7. Solid machine/machine remaining material - roughing
8. Finishing (base/edge)
9. Chamfering

Note

The following error messages can occur when chamfering inside contours:

Safety clearance in the program header too large

This error message appears when chamfering would, in principle, be possible with the parameters entered for FS and ZFS, but the safety clearance then could not be maintained.

Immersion depth too large

This error message appears when chamfering would be possible through the reduction of the immersion depth ZFS.

Tool diameter too large

This error message appears when the tool would already damage the edges during insertion. In this case, the chamfer FS must be reduced.



Software option

For solid machining residual material, you require the option "residual material detection and machining".

Name convention

For multi-channel systems, cycles attach a "_C" and a two-digit number of the specific channel to the names of the programs to be generated, e.g. for channel 1 "_C01". This is the reason that the name of the main program must not end with "_C" and a two-digit number. This is monitored by the cycles.

For single-channel systems, cycles do not extend the name of the programs to be generated.

Note

G code programs

For G code programs, the programs to be generated, which do not include any path data, are saved in the directory in which the main program is located. In this case, it must be ensured that programs, which already exist in the directory and which have the same name as the programs to be generated, are overwritten.

10.5.9 Predrilling contour pocket (CYCLE64)

Function

In addition to predrilling, the cycle can be used for centering. The centering or predrilling program generated by the cycle is called for this purpose.

To prevent the drill slipping during drilling, you can center it first.

Before you predrill the pocket, you must enter the pocket contour. If you want to center before predrilling, you have to program the two machining steps in separate blocks.

The number and positions of the necessary predrilled holes depend on the specific circumstances (such as shape of contour, tool, plane infeed, finishing allowance) and are calculated by the cycle.

If you mill several pockets and want to avoid unnecessary tool changes, predrill all the pockets first and then remove the stock.

In this case, for centering/predrilling, you also have to enter the parameters that appear when you press the "All parameters" softkey. These parameters must correspond to the parameters from the previous stock removal step. When programming, proceed as follows:

1. Contour pocket 1
2. Centering
3. Contour pocket 2
4. Centering

5. Contour pocket 1
6. Predrilling
7. Contour pocket 2
8. Predrilling
9. Contour pocket 1
10. Stock removal
11. Contour pocket 2
12. Stock removal

If you are doing all the machining for the pocket at once, i.e. centering, rough-drilling and removing stock directly in sequence, and do not set the additional parameters for centering/rough-drilling, the cycle will take these parameter values from the stock removal (roughing) machining step. When programming in G code, these values must be specifically re-entered.

Note

Execution from external media

If you execute programs from an external drive (e.g. local drive or network drive), you require the "Execution from external storage (EES)" function.

For additional information, please refer to the following references:

SINUMERIK Operate Commissioning Manual

Clamping the spindle

For ShopTurn, the "Clamp spindle" function can be set up by the machine manufacturer.



Machine manufacturer

Please refer to the machine manufacturer's specifications.

See also

Clamping the spindle (Page 293)

Procedure when centering



1. The part program or ShopTurn program to be processed has been created and you are in the editor.
2. Press the "Milling", "Mill contour", "Predrilling" and "Centering" softkeys. The "Centering" input window opens.

10.5 Contour milling

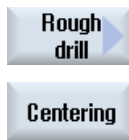

G code program parameters			ShopTurn program parameters		
PRG	Name of the program to be generated		T	Tool name	
PL	Machining plane		D	Cutting edge number	
	Milling direction	<ul style="list-style-type: none"> Climbing Conventional 	F	Feedrate	mm/min mm/tooth
RP	Retraction plane	mm	S / V	Spindle speed or constant cutting rate	rpm m/min
SC	Safety clearance	mm			
F	Feedrate	mm/min			





Parameter	Description	Unit
TR	Reference tool Tool, which is used in the "stock removal" machining step. This is used to determine the plunge position.	
Machining surface (only for Shop-Turn)	<ul style="list-style-type: none"> Face C End face Y (only when Y axis exists) Face B Peripheral surface C Peripheral surface Y (only when Y axis exists) 	
(only for Shop-Turn)	Clamp/release spindle (only for end face Y/B and peripheral surface Y) The function must be set up by the machine manufacturer.	
Z0	Reference point in the tool axis Z	mm
Z1	Pocket depth \varnothing (abs) or depth referred to Z0	mm
CP	Positioning angle for machining area - (only for ShopTurn, machining surface, face Y) Angle CP does not have any effect on the machining position in relation to the workpiece. It is only used to position the workpiece with the rotary axis C in such a way that machining is possible on the machine.	Degrees
C0	Positioning angle for machining surface - (only for ShopTurn, machining surface, peripheral surface Y)	Degrees
DXY	<ul style="list-style-type: none"> Maximum plane infeed Maximum plane infeed as a percentage of the milling cutter diameter 	mm %

Parameter	Description	Unit
UXY	Finishing allowance, plane	mm
Lift mode 	Lift mode before new infeed If the machining operation requires several points of insertion, the retraction height can be programmed: <ul style="list-style-type: none"> • To retraction plane • Z0 + safety clearance When making the transition to the next insertion point, the tool returns to this height. If there are no elements larger than Z0 in the pocket area, "Z0 + safety clearance" can be selected as the lift mode.	mm mm





Predrilling procedure



1. The part program or ShopTurn program to be processed has been created and you are in the editor.
2. Press the "Milling", "Contour milling", "Predrilling" and "Predrilling" soft-keys.
The "Predrilling" input window opens.

G code program parameters			ShopTurn program parameters		
PRG	Name of the program to be generated		T	Tool name	
PL 	Machining plane		D	Cutting edge number	
Milling direction 	<ul style="list-style-type: none"> • Climbing • Conventional 		F 	Feedrate	mm/min mm/tooth
RP	Retraction plane	mm	S / V 	Spindle speed or constant cutting rate	rpm m/min
SC	Safety clearance	mm			
F	Feedrate	mm/min			

10.5 Contour milling

Parameter	Description	Unit
TR	Reference tool Tool, which is used in the "stock removal" machining step. This is used to determine the plunge position.	
Machining surface  (only for Shop-Turn)	<ul style="list-style-type: none"> • Face C • Face Y • Face B • Peripheral surface C • Peripheral surface Y 	
  (only for Shop-Turn)	Clamp/release spindle (only for end face Y/B and peripheral surface Y) The function must be set up by the machine manufacturer.	
Z0	Reference point in the tool axis Z	mm
Z1	Pocket depth (abs) or depth referred to Z0 or X0 (inc)	mm
CP	Positioning angle for machining area - (only for ShopTurn, machining surface, face Y) Angle CP does not have any effect on the machining position in relation to the workpiece. It is only used to position the workpiece with the rotary axis C in such a way that machining is possible on the machine.	Degrees
C0	Positioning angle for machining surface - (only for ShopTurn, machining surface, peripheral surface Y)	Degrees
DXY	<ul style="list-style-type: none"> • Maximum plane infeed • Maximum plane infeed as a percentage of the milling cutter diameter 	mm %
UXY	Finishing allowance, plane	mm
UZ	Finishing allowance, depth	mm
Lift mode 	Lift mode before new infeed If the machining operation requires several points of insertion, the retraction height can be programmed: <ul style="list-style-type: none"> • To retraction plane • Z0 + safety clearance When making the transition to the next insertion point, the tool returns to this height. If there are no elements larger than Z0 (X0) in the pocket area, then Z0 (X0) + safety clearance can be programmed as the lift mode.	mm mm

10.5.10 Milling contour pocket (CYCLE63)

Function

You can use the "Mill pocket" function to mill a pocket on the face or peripheral surface.

Before you remove stock from the pocket, you must first enter the contour of the pocket and, if applicable, the contour of an island. Stock is removed from the pocket parallel to the contour

from the inside to the outside. The direction is determined by the machining direction (up-cut or down-cut). If an island is located in the pocket, the cycle automatically takes this into account during stock removal.

Note**Execution from external media**

If you execute programs from an external drive (e.g. local drive or network drive), you require the "Execution from external storage (EES)" function.

For additional information, please refer to the following references:

SINUMERIK Operate Commissioning Manual

Clamping the spindle

For ShopTurn, the "Clamp spindle" function can be set up by the machine manufacturer.

**Machine manufacturer**

Please refer to the machine manufacturer's specifications.

Input simple

For simple machining operations, you have the option to reduce the wide variety of parameters to the most important parameters using the "Input" selection field. In this "Input simple" mode, the hidden parameters are allocated a fixed value that cannot be adjusted.

**Machine manufacturer**

Various defined values can be pre-assigned using setting data.

Please refer to the machine manufacturer's specifications.

If the workpiece programming requires it, you can display and change all of the parameters using "Input complete".

Machining type

For solid machining, you can select the machining type (roughing or finishing). If you want to rough and then finish, you have to call the machining cycle twice (block 1 = roughing, block 2 = finishing). The programmed parameters are retained when the cycle is called for the second time.

During insertion with oscillation, the message "Ramp path too short" will appear if the tool is less than the milling cutter diameter away from the insertion point along the ramp, or the machining depth is not reached.

- Reduce the insertion angle if the tool remains too close to the insertion point.
- Increase the insertion angle if the tool does not reach the machining depth.
- If necessary, use a tool with a smaller radius of select a different insertion mode.

10.5 Contour milling

Procedure





1. The part program or ShopTurn program to be processed has been created and you are in the editor.
2. Press the "Milling", "Contour milling" and "Pocket" softkeys. The "Mill pocket" input window opens.



Parameters in the "Input complete" mode

Parameters, G code program			Parameters, ShopTurn program		
Input		• Complete			
PRG	Name of the program to be generated		T	Tool name	
PL	Machining plane		D	Cutting edge number	
Milling direction		<ul style="list-style-type: none"> • Climbing • Conventional milling 	F	Feedrate	mm/min mm/tooth
RP	Retraction plane	mm	S / V	Spindle speed or constant cutting rate	rpm m/min
SC	Safety clearance	mm			
F	Feedrate	mm/min			





Parameter	Description	Unit
Machining surface (only for Shop-Turn)	<ul style="list-style-type: none"> • Face C • Face Y • Face B • Peripheral surface C • Peripheral surface Y 	
 (only for Shop-Turn)	Clamp/release spindle (only for end face Y/B and peripheral surface Y) The function must be set up by the machine manufacturer.	
Machining 	The following machining operations can be selected: <ul style="list-style-type: none"> • ▽ (roughing) • ▽▽▽ base (base finishing) • ▽▽▽ edge (edge finishing) • Chamfering 	



Parameter	Description	Unit
Z0	Reference point in the tool axis Z	mm
Z1	Pocket depth (abs) or depth referred to Z0	mm
CP	Positioning angle for machining area - (only for ShopTurn, machining surface, face Y) Angle CP does not have any effect on the machining position in relation to the workpiece. It is only used to position the workpiece with the rotary axis C in such a way that machining is possible on the machine.	Degrees
C0	Positioning angle for machining surface - (only for ShopTurn, machining surface, peripheral surface Y)	Degrees
DXY	<ul style="list-style-type: none"> Maximum plane infeed Maximum plane infeed as a percentage of the milling cutter diameter 	mm %
DZ	Maximum depth infeed	mm
UXY	Finishing allowance, plane	mm
UZ	Finishing allowance, depth	mm
Starting point	<ul style="list-style-type: none"> Manual Starting point is entered Automatic Starting point is automatically calculated 	
XS	Starting point X - (only for "manual" starting point)	mm
YS	Starting point Y - (only for "manual" starting point)	mm
Insertion 	<p>The following insertion modes can be selected – (only for ▽, ▽▽ base or ▽▽▽ edge):</p> <ul style="list-style-type: none"> Vertical insertion The calculated actual infeed depth is executed at the calculated position for "automatic" starting point – or at the specified position for "manual" starting point. Note This setting can be used only if the cutter can cut across center or if the pocket has been predrilled. Helical insertion Insertion along a helical path. The cutter center point traverses along the helical path determined by the radius and depth per revolution (helical path). If the depth for one infeed has been reached, a full circle motion is executed to eliminate the inclined insertion path. Oscillating insertion Oscillating insertion at the center axis of the rectangular pocket. The cutter center point oscillates back and forth along a linear path until it reaches the depth infeed. When the depth has been reached, the path is traversed again without depth infeed in order to eliminate the inclined insertion path. 	
FZ  (only for ShopTurn)	Depth infeed rate – (for vertical insertion only)	mm/min mm/tooth
FZ (only for G code)	Depth infeed rate – (for vertical insertion only)	mm/min
EP	Maximum pitch of helix – (for helical insertion only)	mm/rev
ER	Radius of helix – (for helical insertion only) The radius cannot be any larger than the milling cutter radius; otherwise, material will remain.	mm





10.5 Contour milling

Parameter	Description	Unit
EW	Note: During insertion with oscillation, the message "Ramp path too short" will appear if the tool is less than the milling cutter diameter away from the insertion point along the ramp. If this occurs, please reduce the angle of insertion.	Degrees
Lift mode 	Lift mode before new infeed If the machining operation requires several points of insertion, the retraction height can be programmed: <ul style="list-style-type: none"> To retraction plane Z0 + safety clearance When making the transition to the next insertion point, the tool returns to this height. If there are no elements larger than Z0 (X0) in the pocket area, then Z0 (X0) + safety clearance can be programmed as the lift mode.	mm mm
FS	Chamfer width for chamfering - (only for chamfering machining)	mm
ZFS 	Insertion depth of tool tip (abs or inc) - (for chamfering machining only)	mm

Parameters in the "Input simple" mode

G code program parameters			ShopTurn program parameters		
Input 		• simple			
PRG	Name of the program to be generated		T	Tool name	
Milling direction 	<ul style="list-style-type: none"> Climbing Conventional 		D	Cutting edge number	
RP	Retraction plane	mm	F 	Feedrate	mm/min mm/rev
F	Feedrate	*	S / V 	Spindle speed or constant cutting rate	rpm m/min

Parameter	Description	
Machining surface  (only for ShopTurn)	<ul style="list-style-type: none"> Face C Face Y Face B Peripheral surface C Peripheral surface Y 	
  (only for ShopTurn)	Clamp/release spindle (only for end face Y/B and peripheral surface Y) The function must be set up by the machine manufacturer.	

Parameter	Description	
Machining 	The following machining operations can be selected: <ul style="list-style-type: none"> • ▽ (roughing) • ▽▽▽ base (base finishing) • ▽▽▽ edge (edge finishing) • Chamfering 	
Z0	Reference point in the tool axis Z	mm
Z1	Pocket depth (abs) or depth referred to Z0 (inc)	mm
CP (only for ShopTurn)	Positioning angle for machining area - (only for machining surface, face Y) Angle CP does not have any effect on the machining position in relation to the workpiece. It is only used to position the workpiece with the rotary axis C in such a way that machining is possible on the machine.	Degrees
C0 (only for ShopTurn)	Positioning angle for machining area - (only for machining surface, peripheral surface Y)	Degrees
DXY 	<ul style="list-style-type: none"> • Maximum plane infeed • Maximum plane infeed as a percentage of the milling cutter diameter 	mm %
DZ	Maximum depth infeed	mm
UXY	Finishing allowance, plane	mm
UZ	Finishing allowance, depth	mm
Insertion 	The following insertion modes can be selected – (only for ▽, ▽▽▽ base or ▽▽▽ edge): <ul style="list-style-type: none"> • Vertical The calculated actual infeed depth is executed at the calculated position for "automatic" starting point – or at the specified position for "manual" starting point. Note: This setting can be used only if the cutter can cut across center or if the pocket has been predrilled. • Helical The cutter center point traverses along the helical path determined by the radius and depth per revolution (helical path). If the depth for one infeed has been reached, a full circle motion is executed to eliminate the inclined insertion path. • Oscillation The cutter center point oscillates back and forth along a linear path until it reaches the depth infeed. When the depth has been reached, the path is traversed again without depth infeed in order to eliminate the inclined insertion path. 	
FZ  (only for ShopTurn)	Depth infeed rate – (only for vertical insertion and ▽)	mm/min mm/tooth
FZ (only for G code)	Depth infeed rate – (only for vertical insertion and ▽)	*
EP	Maximum pitch of helix – (for helical insertion only)	mm/rev
ER	Radius of helix – (for helical insertion only) The radius cannot be any larger than the milling cutter radius; otherwise, material will remain.	mm
EW	Note: During insertion with oscillation, the message "Ramp path too short" will appear if the tool is less than the milling cutter diameter away from the insertion point along the ramp. If this occurs, please reduce the angle of insertion.	Degrees
FS	Chamfer width for chamfering (inc) - (for chamfering only)	mm
ZFS 	Insertion depth of tool tip (abs or inc) - (for chamfering only)	mm

* Unit of feedrate as programmed before the cycle call

Hidden parameters

The following parameters are hidden. They are pre-assigned fixed values or values that can be adjusted using setting data.

Parameter	Description	Value	Can be set in SD
PL (only for G code)	Machining plane	Defined in MD 52005	
SC (only for G code)	Safety clearance	1 mm	x
Starting point	Starting point is automatically calculated - (only for ∇ and ∇∇∇ base)	Automatic	
Lift mode	Lift mode before new infeed - (only for ∇, ∇∇∇ base or ∇∇∇ edge)	to RP	



Machine manufacturer

Please refer to the machine manufacturer's specifications.

10.5.11 Contour pocket residual material (CYCLE63, option)

Function

When you have removed stock from a pocket (with/without islands) and there is residual material, then this is automatically detected. You can use a suitable tool to remove this residual material without having to machine the whole pocket again, i.e. avoiding unnecessary non-productive motion. The finishing allowance should be set identically for all machining steps because it does not count as residual material.

The residual material is calculated on the basis of the milling cutter used for stock removal.

It is also possible to run multiple residual material steps one after the other. In this case, the milling tool should be selected to be smaller by a factor of no more than 3 for each new step.

If you mill several pockets and want to avoid unnecessary tool changeover, remove stock from all the pockets first and then remove the residual material. In this case, when removing the residual material, you must also enter a value for the reference tool TR parameter, which, in the ShopTurn program, additionally appears when you press the "All parameters" softkey. When programming, proceed as follows:

1. Contour pocket 1
2. Stock removal
3. Contour pocket 2
4. Stock removal
5. Contour pocket 1

6. Removing residual stock
7. Contour pocket 2
8. Removing residual stock



Software option

For removing residual stock, you require the option "residual stock detection and machining".

Clamping the spindle

For ShopTurn, the "Clamp spindle" function can be set up by the machine manufacturer.



Machine manufacturer

Please observe the information provided by the machine manufacturer.

See also

Clamping the spindle (Page 293)



Procedure

1. The part program or ShopTurn program to be processed has been created and you are in the editor.
2. Press the "Milling", "Contour milling" and "Pocket resid. mat." softkeys.







The "Pocket Res. Mat." input window opens.

3. For the ShopTurn program, press the "All parameters" softkey if you want to enter additional parameters.

G code program parameters			ShopTurn program parameters		
PRG	Name of the program to be generated		T	Tool name	
PL	Machining plane		D	Cutting edge number	
	Milling direction 	<ul style="list-style-type: none"> • Climbing • Conventional 	F	Feedrate	mm/min mm/tooth
RP	Retraction plane	mm	S / V	Spindle speed or constant cutting rate	rpm m/min
SC	Safety clearance	mm			
F	Feedrate	mm/min			

10.5 Contour milling

Parameter	Description	Unit
Machining surface  (only for Shop-Turn)	<ul style="list-style-type: none"> • Face C • Face Y • Face B • Peripheral surface C • Peripheral surface Y 	
  (only for Shop-Turn)	Clamp/release spindle (only for end face Y/B and peripheral surface Y) The function must be set up by the machine manufacturer.	
TR	Reference tool Tool, which is used in the "stock removal" machining step. This is used to determine the residual corners.	
D 	Cutting edge number	
Z0	Reference point in the tool axis Z	mm
Z1	Pocket depth (abs) or depth referred to Z0 or X0 (inc)	mm
CP	Positioning angle for machining area - (only for ShopTurn, machining surface, face Y) Angle CP does not have any effect on the machining position in relation to the workpiece. It is only used to position the workpiece with the rotary axis C in such a way that machining is possible on the machine.	Degrees
C0	Positioning angle for machining surface - (only for ShopTurn, machining surface, peripheral surface Y)	Degrees
DXY	<ul style="list-style-type: none"> • Maximum plane infeed • Maximum plane infeed as a percentage of the milling cutter diameter 	mm %
DZ	Maximum depth infeed	
Lift mode 	Lift mode before new infeed If the machining operation requires several points of insertion, the retraction height can be programmed: <ul style="list-style-type: none"> • To retraction plane • Z0 + safety clearance When making the transition to the next insertion point, the tool returns to this height. If there are no elements larger than Z0 (X0) in the pocket area, then Z0 (X0) + safety clearance can be programmed as the lift mode.	mm mm

10.5.12 Milling contour spigot (CYCLE63)

Function

You can use the "Mill spigot" function to mill any spigots on the face or peripheral surface.

Before you mill the spigot, you must first enter a blank contour and then one or more spigot contours. The blank contour defines the area, outside of which there is no material, i.e. there,

the tool moves with rapid traverse. Material is then removed between the blank contour and spigot contour.

Note**Execution from external media**

If you execute programs from an external drive (e.g. local drive or network drive), you require the "Execution from external storage (EES)" function.

For additional information, please refer to the following references:

SINUMERIK Operate Commissioning Manual

Clamping the spindle

For ShopTurn, the "Clamp spindle" function can be set up by the machine manufacturer.

**Machine manufacturer**

Please refer to the machine manufacturer's specifications.

Input simple

For simple machining operations, you have the option to reduce the wide variety of parameters to the most important parameters using the "Input" selection field. In this "Input simple" mode, the hidden parameters are allocated a fixed value that cannot be adjusted.

**Machine manufacturer**

Various defined values can be pre-assigned using setting data.

Please refer to the machine manufacturer's specifications.

If the workpiece programming requires it, you can display and change all of the parameters using "Input complete".

Machining type

You can select the machining type (roughing, base finishing, edge finishing, chamfer) for milling. If you want to rough and then finish, you have to call the machining cycle twice (block 1 = roughing, block 2 = finishing). The programmed parameters are retained when the cycle is called for the second time.

Approach/retraction

1. The tool approaches the starting point at rapid traverse at the height of the retraction plane and is fed in to the safety clearance. The cycle calculates the starting point.
2. The tool first infeeds to the machining depth and then approaches the spigot contour from the side in a quadrant at machining feedrate.

10.5 Contour milling

3. The spigot is machined in parallel with the contours from the outside in. The direction is determined by the machining direction (climb/conventional) (see "Changing program settings").
4. When the first plane of the spigot has been machined, the tool retracts from the contour in a quadrant and then infeeds to the next machining depth.
5. The spigot is again approached in a quadrant and machine in parallel with the contours from outside in.
6. Steps 4 and 5 are repeated until the programmed spigot depth is reached.
7. The tool retracts to the safety clearance at rapid traverse.

Procedure









1. The part program or ShopTurn program to be processed has been created and you are in the editor.
2. Press the "Milling", "Contour milling" and "Spigot" softkeys. The "Mill spigot" input window opens.





3. Select the "Roughing" machining type.





Parameters in the "Input complete" mode

Parameters, G code program			Parameters, ShopTurn program		
Input		• Complete			
PRG	Name of the program to be generated		T	Tool name	
PL	Machining plane		D	Cutting edge number	
	Milling direction	<ul style="list-style-type: none"> • Climbing • Conventional milling 	F	Feedrate	mm/min mm/tooth
RP	Retraction plane	mm	S / V	Spindle speed or constant cutting rate	rpm m/min
SC	Safety clearance	mm			
F	Feedrate	mm/min			

Parameter	Description	Unit
Machining surface  (only for Shop-Turn)	<ul style="list-style-type: none"> • Face C • Face Y • Face B • Peripheral surface C • Peripheral surface Y 	
  (only for Shop-Turn)	Clamp/release spindle (only for end face Y/B and peripheral surface Y) The function must be set up by the machine manufacturer.	
Machining 	The following machining operations can be selected: <ul style="list-style-type: none"> • ▽ (roughing) • ▽▽ base (base finishing) • ▽▽ edge (edge finishing) • Chamfering 	
Z0	Reference point in tool axis Z	mm
Z1	Pocket depth (abs) or depth referred to Z0 or X0 (inc)	mm
CP	Positioning angle for machining area - (only for ShopTurn, machining surface, face Y) Angle CP does not have any effect on the machining position in relation to the workpiece. It is only used to position the workpiece with the rotary axis C in such a way that machining is possible on the machine.	Degrees
C0	Positioning angle for machining surface - (only for ShopTurn, machining surface, peripheral surface Y)	Degrees
 DXY	<ul style="list-style-type: none"> • Maximum plane infeed • Maximum plane infeed as a percentage of the milling cutter diameter - (only for ▽ and ▽▽ base) 	mm %
DZ	Maximum depth infeed - (only for ▽ or ▽▽ edge)	mm
UXY	Finishing allowance, plane - (only for ▽, ▽▽ base or ▽▽ edge)	mm
UZ	Finishing allowance, depth - (only for ▽ or ▽▽ base)	mm
Lift mode 	Lift mode before new infeed If the machining operation requires several points of insertion, the retraction height can be programmed: <ul style="list-style-type: none"> • To retraction plane • Z0 + safety clearance When making the transition to the next insertion point, the tool returns to this height. If there are no elements larger than Z0 (X0) in the pocket area, then Z0 (X0) + safety clearance can be programmed as the lift mode.	mm mm mm
FS	Chamfer width for chamfering - (only for chamfering machining)	mm
ZFS 	Insertion depth of tool tip (abs or inc) - (for chamfering machining only)	mm

Parameters in the "Input simple" mode

G code program parameters			ShopTurn program parameters		
Input 		• simple			
PRG	Name of the program to be generated		T	Tool name	
Milling direction 	<ul style="list-style-type: none"> • Climbing • Conventional 		D	Cutting edge number	
RP	Retraction plane	mm	F 	Feedrate	mm/min mm/rev
F	Feedrate	*	S / V 	Spindle speed or constant cutting rate	rpm m/min

Parameter	Description	
Machining surface  (only for ShopTurn)	<ul style="list-style-type: none"> • Face C • Face Y • Face B • Peripheral surface C • Peripheral surface Y 	
  (only for ShopTurn)	Clamp/release spindle (only for end face Y/B and peripheral surface Y) The function must be set up by the machine manufacturer.	
Machining 	The following machining operations can be selected: <ul style="list-style-type: none"> • ∇ (roughing) • ∇∇∇ base (base finishing) • ∇∇∇ edge (edge finishing) • Chamfering 	
Z0	Reference point in the tool axis Z	mm
Z1	Pocket depth (abs) or depth referred to Z0 (inc)	mm
CP (only for ShopTurn)	Positioning angle for machining area - (only for machining surface, face Y) Angle CP does not have any effect on the machining position in relation to the workpiece. It is only used to position the workpiece with the rotary axis C in such a way that machining is possible on the machine.	Degrees
C0 (only for ShopTurn)	Positioning angle for machining area - (only for machining surface, peripheral surface Y)	Degrees
DXY 	<ul style="list-style-type: none"> • Maximum plane infeed • Maximum plane infeed as a percentage of the milling cutter diameter- (only for ∇ and ∇∇∇ base) 	mm %
DZ	Maximum depth infeed - (only for ∇ and ∇∇∇ edge)	mm
UXY	Plane finishing allowance – (only for ∇, ∇∇∇ base and ∇∇∇ edge)	mm
UZ	Depth finishing allowance (only for ∇ and ∇∇∇ base)	mm

Parameter	Description	
FS	Chamfer width for chamfering - (for chamfering only)	mm
ZFS 	Insertion depth of tool tip (abs or inc) - (for chamfering only)	mm

* Unit of feedrate as programmed before the cycle call

Hidden parameters

The following parameters are hidden. They are pre-assigned fixed values or values that can be adjusted using setting data.

Parameter	Description	Value	Can be set in SD
PL (only for G code)	Machining plane	Defined in MD 52005	
SC (only for G code)	Safety clearance	1 mm	x
Lift mode	Lift mode before new infeed - (only for ∇ , $\nabla\nabla$ base or $\nabla\nabla\nabla$ edge)	to RP	



Machine manufacturer

Please refer to the machine manufacturer's specifications.

10.5.13 Contour spigot residual material (CYCLE63, option)

Function

When you have milled a contour spigot and residual material remains, then this is automatically detected. You can use a suitable tool to remove this residual material without having to machine the whole spigot again, i.e. avoiding unnecessary non-productive motion. The finishing allowance should be set identically for all machining steps because it does not count as residual material.

The residual material is calculated on the basis of the milling cutter used for clearing.

It is also possible to run multiple residual material steps one after the other. In this case, the milling tool should be selected to be smaller by a factor of no more than 3 for each new step.

If you mill several spigots and want to avoid unnecessary tool changeover, clear all the spigots first and then remove the residual material. In this case, when removing the residual material, you must also enter a value for the reference tool TR parameter, which, in the ShopTurn program, additionally appears when you press the "All parameters" softkey. When programming, proceed as follows:

1. Contour blank 1
2. Contour spigot 1
3. Clear spigot 1

10.5 Contour milling

- 4. Contour blank 2
- 5. Contour spigot 2
- 6. Clear spigot 2
- 7. Contour blank 1
- 8. Contour spigot 1
- 9. Removing residual stock spigot 1
- 10. Contour blank 2
- 11. Contour spigot 2
- 12. Removing residual stock spigot 2



Software option

For removing residual stock, you require the option "residual stock detection and machining".

Clamping the spindle

For ShopTurn, the "Clamp spindle" function can be set up by the machine manufacturer.



Machine manufacturer

Please observe the information provided by the machine manufacturer.

See also

Clamping the spindle (Page 293)





Procedure







1. The part program or ShopTurn program to be processed has been created and you are in the editor.
2. Press the "Milling", "Contour milling" and "Spigot resid. mat." softkeys.

The "Spigot Res. Mat." input window opens.

3. For the ShopTurn program, press the "All parameters" softkey if you want to enter additional parameters.

G code program parameters			ShopTurn program parameters		
PRG	Name of the program to be generated		T	Tool name	
PL	Machining plane		D	Cutting edge number	
			F	Feedrate	mm/min mm/tooth
Milling direction 	<ul style="list-style-type: none"> • Climbing • Conventional 			S / V	Spindle speed or constant cutting rate
RP	Retraction plane	mm			rpm m/min
SC	Safety clearance	mm			
F	Feedrate	mm/min			

Parameter	Description	Unit
Machining	The following machining technologies can be selected: <ul style="list-style-type: none"> • ▽ (roughing) 	
Machining surface  (only for Shop-Turn)	<ul style="list-style-type: none"> • Face C • Face Y • Face B • Peripheral surface C • Peripheral surface Y 	
  (only for Shop-Turn)	Clamp/release spindle (only for end face Y/B and peripheral surface Y) The function must be set up by the machine manufacturer.	
TR	Reference tool Tool, which is used in the "stock removal" machining step. This is used to determine the residual corners.	
D	Cutting edge number	
Z0	Reference point in tool axes Z	mm
 Z1	Pocket depth (abs) or depth referred to Z0	mm
CP	Positioning angle for machining area - (only for ShopTurn, machining surface, face Y) Angle CP does not have any effect on the machining position in relation to the workpiece. It is only used to position the workpiece with the rotary axis C in such a way that machining is possible on the machine.	Degrees
C0	Positioning angle for machining surface - (only for ShopTurn, machining surface, peripheral surface Y)	Degrees
 DXY	<ul style="list-style-type: none"> • Maximum plane infeed • Maximum plane infeed as a percentage of the milling cutter diameter 	mm %
DZ	Maximum depth infeed	

10.5 Contour milling

Parameter	Description	Unit
Lift mode U	<p>Lift mode before new infeed</p> <p>If the machining operation requires several points of insertion, the retraction height can be programmed:</p> <ul style="list-style-type: none"> • To retraction plane • Z0 + safety clearance <p>When making the transition to the next insertion point, the tool returns to this height. If there are no elements larger than Z0 in the pocket area, "Z0 + safety clearance" can be selected as the lift mode.</p>	mm mm
FS	Chamfer width for chamfering - (only for chamfering machining)	mm
ZFS U	Insertion depth of tool tip (abs or inc) - (for chamfering machining only)	mm

10.6 Further cycles and functions

10.6.1 Swiveling plane / aligning tool (CYCLE800)

The CYCLE800 swivel cycle is used to swivel to any surface in order to either machine or measure it. In this cycle, the active workpiece zeros and the work offsets are converted to the inclined surface taking into account the kinematic chain of the machine by calling the appropriate NC functions and rotary axes (optionally) are positioned.

Swiveling can be realized:

- axis-by-axis
- via solid angle
- via projection angle
- directly

Before the rotary axes are positioned, the linear axes can be retracted if desired.

Swiveling always means three geometry axes.

In the basic version, the following functions

- 3 + 2 axes, inclined machining and
- Toolholder with orientation capability

are available.

Setting/aligning tools for a G code program

The swivel function also includes the "Setting tool", "Align milling tool" and "Align turning tool" functions. When setting and aligning, contrary to swiveling, the coordinate system (WCS) is not rotated at the same time.

Prerequisites before calling the swivel cycle

A tool (tool cutting edge $D > 0$) and the work offset (WO), with which the workpiece was scratched or measured, must be programmed before the swivel cycle is first called in the main program.

Example:

```

N1 T1D1
N2 M6
N3 G17 G54
N4 CYCLE800(1,"",0,57,0,0,0,0,0,0,0,0,0,0,0,0,1,0,1)) ;swivel ZERO to
;initial position of the
;machine kinematics
N5 WORKPIECE(,,,,,"BOX",0,0,50,0,0,0,100,100) ;blank declaration for
;simulation and
;simultaneous recording

```

For machines where swivel is set-up, each main program with a swivel should start in the initial position of the machine.

The definition of the blank (WORKPIECE) always refers to the currently effective work offset. For programs that use "swivel", a swivel to zero must be made before the blank is defined. For ShopTurn programs, the blank in the program header is automatically referred to the unswiveled state.

In the swivel cycle, the work offset (WO) as well as the shifts and rotations of the parameters of the CYCLE800 are converted to the corresponding machining plane. The work offset is kept. Shifts and rotations are saved in system frames - the swivel frames (displayed under parameter/work offsets):

- Tool reference (\$P_TOOLFRAME)
- Rotary table reference (\$P_PARTFRAME)
- Workpiece reference (\$P_WPFRAME)

The swivel cycle takes into account the actual machining plane (G17, G18, G19).

Swiveling on a machining or auxiliary surface always involves 3 steps:

- Shifting the WCS before rotation
- Rotating the WCS (axis-by-axis, ...)
- Shifting the WCS after rotation

The shifts and rotations refer to the coordinate system X, Y, Z of the workpiece and are therefore independent of the machine (with the exception of swivel "rotary axis direct").

No programmable frames are used in the swivel cycle. The frames programmed by the user are taken into account for additive swiveling.

On the other hand, when swiveling to a new swivel plane, the programmable frames are deleted. Any type of machining operation can be performed on the swivel plane, e.g. by calling standard or measuring cycles.

The last swivel plane remains active after a program reset or when the power fails. The behavior at reset and power on can be set using machine data.



Machine manufacturer

Please refer to the machine manufacturer's specifications.

Block search when swiveling the plane / swiveling the tool

For block search with calculation, after NC start, initially, the automatic rotary axes of the active swivel data set are pre-positioned and then the remaining machine axes are positioned. This does not apply if a type TRACYL or TRANSMIT transformation is active after the block search. In this case, all axes simultaneously move to the accumulated positions.



Machine manufacturer

Please refer to the machine manufacturer's specifications.

Aligning tools

The purpose of the "Align turning tool" function is to support turning machines with a swivel-mounted B axis. The position and orientation of the turning tool can be changed by rotating swivel axis B (around Y) and the tool spindle.

In contrast to "Swivel plane", no rotation is operative in the active work offsets in the workpiece coordinate system in the case of "Align tool".

The maximum angular range for "Align milling tool" is limited by the traversing range of the participating rotary axes. Technological limits are also placed on the angular range depending on the tool used.

When aligning the tool, using the CUTMOD NC command, the tool data are calculated online based on the tool orientation (positions of the B axis and the tool spindle). For a turning tool, this involves the cutting edge position, the holder angle and the cut direction.

Name of swivel data set

Selecting the swivel data set or deselecting the swivel data set.

The selection can be hidden by the machine data.

For "Swivel plane" and "Swivel tool" / "Set tool", only the swivel data sets are available for selection where no B axis kinematics, turning technology has been set.

"Swivel tool" / "Align tool", only the swivel data sets are available for selection where B axis kinematics, turning technology has been set.



Machine manufacturer

Please refer to the machine manufacturer's specifications.

Approaching a machining operation

When approaching the programmed machining operation in the swiveled plane, under worst case conditions, the software limit switches could be violated. In this case, the system travels along the software limit switches above the retraction plane. In the event of violation below the retraction plane, for safety reasons, the program is interrupted with an alarm. To avoid this, before swiveling, e.g. move the tool in the X/Y plane and position it as close as possible to the starting point of the machining operation or define the retraction plane closer to the workpiece.

Retraction

Before swiveling the axes, move the tool to a safe retraction position. The retraction versions available are defined when starting up the system (commissioning).

The retraction mode is modal. When a tool is changed or after a block search, the retraction mode last set is used.



Machine manufacturer

Please observe the information provided by the machine manufacturer.



WARNING

Risk of collision

You must select a retraction position that avoids a collision between the tool and workpiece when swiveling.

Tool

To avoid collisions, use 5-axis transformation (software option) to define the position of the tool tip during swiveling.

- **Correct**
The position of the tool tip is corrected during swiveling (tracking function).
- **No correction**
The position of the tool tip is not corrected (not tracked) during swiveling.



Machine manufacturer

Please observe the information provided by the machine manufacturer.

Swivel plane (only for G code programming)

- **New**

Previously active swivel frames and programmed frames are deleted. A new swivel frame is formed according to the values specified in the input screen.

Every main program must begin with a swivel cycle with the new swivel plane, in order to ensure that a swivel frame from another program is not active.

- **Additive**

The swivel frame is added to the swivel frame from the last swivel cycle.

If several swivel cycles are programmed in a program and programmable frames are also active between them (e.g., AROT ATRANS), these are taken into account in the swivel frame. If a swivel data set is activated that was not previously active, the swivel frames are not deleted.

If the currently active work offset contains rotations, e.g., due to previous workpiece measuring operations, they will be taken into account in the swivel cycle.

Swivel mode

Swiveling can either be realized axis-by-axis, using the angle in space, using the projection angle or directly. The machine manufacturer determines when setting up the "Swivel plane/swivel tool" function which swivel methods are available.



Machine manufacturer

Please refer to the machine manufacturer's specifications.

- **Axis by axis**
In the case of axis-by-axis swiveling, the coordinate system is rotated about each axis in turn, with each rotation starting from the previous rotation. The axis sequence can be freely selected.
- **Solid angle**
With the solid angle swiveling option, the tool is first rotated about the Z axis and then about the Y axis. The second rotation starts from the first.
- **Projection angle**
When swiveling using the projection angle, the angle value of the swiveled surface is projected onto the first two axes of the right-angle coordinate system. The user can freely select the axis rotation sequence.
The 3rd rotation is based on the previous rotation. The active plane and the tool orientation must be taken into consideration when the projection angle is used:
 - For G17 projection angle XY, 3rd rotation around Z
 - For G18 projection angle ZX, 3rd rotation around Y
 - For G19 projection angle YZ, 3rd rotation around X

When projection angles around XY and YX are programmed, the new X-axis of the swiveled coordinate system lies in the old ZX plane.

When projection angles around XZ and ZX are programmed, the new Z-axis of the swiveled coordinate system lies in the old Y-Z plane.

When projection angles around YZ and ZY are programmed, the new Y-axis of the swiveled coordinate system lies in the old X-Y plane.

- **directly**
For direct swiveling, the required positions of the rotary axes are specified. The HMI calculates a suitable new coordinate system based on these values. The tool axis is aligned in the Z direction. You can derive the resulting direction of the X and Y axis by traversing the axes.

Note

Direction of rotation

The positive direction of each rotation for the different swivel versions is shown in the help displays.

Axis sequence

Sequence of the axes which are rotated around:

XYZ or XZY or YXZ or YZX or ZXY or ZYX

Direction (minus/plus)

Direction reference of traversing direction of rotary axis 1 or 2 of the active swivel data set (machine kinematics). The NC calculates two possible solutions of the rotation / offset programmed in CYCLE800 using the angle traversing range of the rotary axes of the machine kinematics. Usually, only one of these solutions is technologically suitable. The solutions differ by 180 degrees in each case. Selecting the "minus" or "plus" direction determines which of the two possible solutions is to be applied.

- "Minus" → Lower rotary axis value
- "Plus" → Higher rotary axis value

Also in the basic setting (pole setting) of the machine kinematics, the NC calculates two solutions and these are approached by CYCLE800. The reference is the rotary axis that was set as direction reference when commissioning the "swivel" function.



Machine manufacturer

Please observe the information provided by the machine manufacturer.











If one of the two positions cannot be reached for mechanical reasons, the alternative position is automatically selected irrespective of the setting of the "Direction" parameter.



Procedure



1. The part program or ShopTurn program to be processed has been created and you are in the editor.
2. Select the "Miscellaneous" softkey.
3. Press the "Swivel plane" softkey.
The "Swivel plane" input window opens.
4. Press the "Basic setting" softkey if you wish to reestablish the initial state, i.e. you wish to set the values back to 0.
This is done, for example, to swivel the coordinate system back to its original orientation.

G code program parameters			ShopTurn program parameters		
PL	Machining plane		T	Tool name	
			D	Cutting edge number	
				Feedrate	mm/min mm/rev
			S / V	Spindle speed or constant cutting rate	rpm m/min

Parameter	Description	Unit
TC 	Name of swivel data set	
Retract  - (only for G code)	No	No retraction before swiveling
	 ink	Incremental retraction in tool direction The retraction path is entered into parameter ZR When retracting in the tool direction, in the swiveled machine state, several axes can move (traverse)
	 max	Maximum retraction in tool direction
	 Z	Retraction in the direction of machine axis Z.
	 ZXY	Retract towards the machine axis Z and then in the direction X, Y
ZR	Retraction path - (only for incremental retraction in the tool direction)	mm
Swivel plane  - (only for G code)	<ul style="list-style-type: none"> • New: New swivel plane • Additive: Additive swivel plane 	
RP - (only for ShopTurn)	Retraction plane for face B	
C0 - (only for ShopTurn)	Position angle for machining surface	Degrees
X0	Reference point for rotation X	
Y0	Reference point for rotation Y	
Z0	Reference point for rotation Z	
Swivel mode 	<ul style="list-style-type: none"> • Axis-by-axis: Swivel coordinate system axis-by-axis • Solid angle: Swivel via solid angle • Proj. angle: Swiveling via projection angle • Direct: Directly position rotary axes 	
Axis sequence 	Sequence of the axes which are rotated around - (only for axis-by-axis swivel mode) XYZ or XZY or YXZ or YZX or ZXY or ZYX	
X	Rotation around X	- (only for axis sequence)
Y	Rotation around Y	
Z	Rotation around Z	
Projection position 	Position of the projection in space - (only for swivel mode, projection angle) X α , Y α , Z β or Y α , Z α , Z β or Z α , X α , Z β	
X α	Projection angle	- (only for projection position)
Y α	Projection angle	
Z β	Angle of rotation in the plane	
Z	Angle of rotation in the plane	Degrees
X1	Zero point of rotated surface X	
Y1	Zero point of rotated surface Y	
Z1	Zero point of rotated surface Z	
Direction  - (only for G code)	Preferred direction, rotary axis 1 - (not for swivel mode direct) <ul style="list-style-type: none"> • + • - 	

Parameter	Description	Unit
Tool  - (only for G code)	Tool tip position when swiveling	
		Tracking The position of the tool tip is maintained during swiveling.
		No tracking The position of the tool tip changes during swiveling.

10.6.2 Swiveling tool (CYCLE800)

10.6.2.1 Aligning turning tools - only for G code program (CYCLE800)

Function

The "Align turning tool" and "Align milling tool" functions support combined turning-milling machines with a B axis that can be swiveled.

In contrast to "Swivel plane", no rotation is operative in the active work offsets in the workpiece coordinate system in the case of "Align tool". Only the offsets calculated by the NC and the corresponding tool orientation are effective.

The maximum angular range for "Align tool" is +/- 360 degrees or it is limited by the traversing range of the participating rotary axes. Technological limits are also placed on the angular range depending on the tool used. When aligning the tool, the data of the tool is calculated based on the tool orientation using the CUTMOD NC command. For a turning tool, the calculation involves the cutting edge position, the holder angle and the cut direction.

Definition of the β and γ angles

The beta and gamma angles orientate the turning tools. They refer to the WCS. If the WCS corresponds to the MCS, the tool data remains unchanged for $\beta=0^\circ / \gamma=0^\circ$ (cutter position, holder angle, ...).

The definition of angles beta and gamma depends on the particular machine. In the initial state of the machine kinematics for turning, a turning tool can be orientated according to Z or X.



Machine manufacturer

Please refer to the machine manufacturer's specifications.

Initial state of the machine kinematics

The tool axis is aligned in the Z direction.

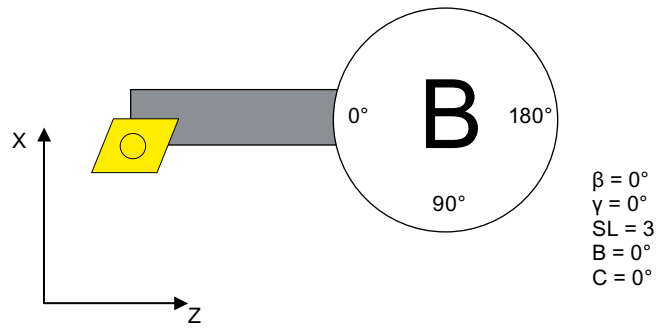

$\beta=90^\circ$ represents a rotation of the cutting plate by +Y.

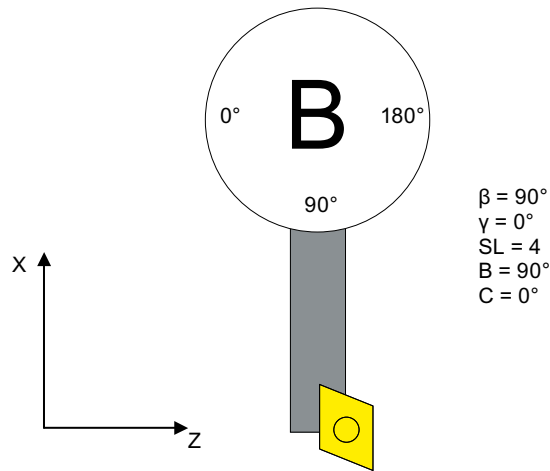

Mirroring

A mirroring of the Z axis (e.g. on the counter-spindle) for $\beta=0^\circ / \gamma=0^\circ$ causes the same machining in the mirrored coordinate system.

The mirroring of the Z axis must be permanently activated in a work offset.

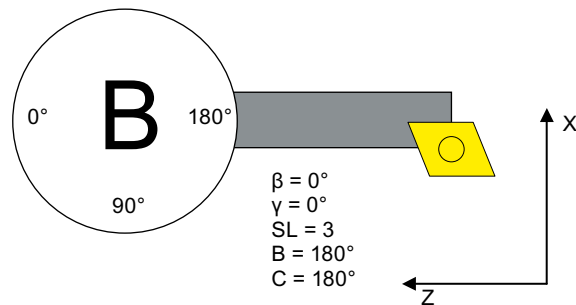

The cutting edge position is calculated using the CUTMOD function.

If milling is to be possible on any swiveled machining plane, then the "swivel plane" function must be used.



Machine manufacturer

Please refer to the machine manufacturer's specifications.

Procedure

1. The part program to be executed has been created and you are in the editor.
2. Select the "Miscellaneous" softkey.
3. Press the "Swivel tool" and "Align turning tool" softkeys.



Parameter	Description		Unit
TC	Name of swivel data set		
Retract	No	No retraction before swiveling	
	ink	Incremental retraction in tool direction The retraction path is entered into parameter ZR.	
	max	Maximum retraction in tool direction	
	Z	Retraction in the direction of machine axis Z	
ZR	Retraction path - (only for incremental retraction in the tool direction)		
β	Rotation around the 3rd geometry axis (for G18 Y)		Degrees
γ	Rotation around the turning tool		Degrees
Tool	Tool tip position when swiveling		
		Follow up The position of the tool tip is maintained during swiveling.	
		No follow up The position of the tool tip changes during swiveling.	

10.6.2.2 Aligning milling tools - only for G code program (CYCLE800)

Procedure

1. The part program to be executed has been created and you are in the editor.
2. Press the "Various" softkey.
3. Press the "Swivel tool" and "Align milling tool" softkeys.
The "Align milling tool" input window opens.



Parameter	Description		Unit
PL	Plane for milling		
TC	Name of the swivel data record		
Retraction	No	No retraction before swiveling	
	ink	Incremental retraction in tool direction The retraction path is entered into parameter ZR.	
	max	Maximum retraction in tool direction	
	Z	Retraction in the direction of machine axis Z	
	ZXY	Retract towards the machine axis Z and then in the direction X, Y	
ZR	Retraction path - (only for incremental retraction in the tool direction)		
β	Rotation around the 3rd geometry axis (for G18 Y)		Degrees
Tool	Tool tip position when swiveling		
		Tracking The position of the tool tip is maintained during swiveling.	
		No tracking The position of the tool tip changes during swiveling.	

10.6.2.3 Preloading milling tools - only for G code program (CYCLE800)

After "Swivel plane", the tool orientation is always perpendicular on the machining plane. When milling with radial cutters, it can make technological sense to set the tool at an angle to the normal surface vector. In the swivel cycle, the setting angle is generated by an axis rotation (max. +/- 90 degrees) to the active swivel plane. When setting, the swivel plane is always "additive". With "Setting tool", only rotations are displayed on the swivel cycle input screen form. The user can freely select the rotation sequence.



Machine manufacturer

Please refer to the machine manufacturer's specifications.

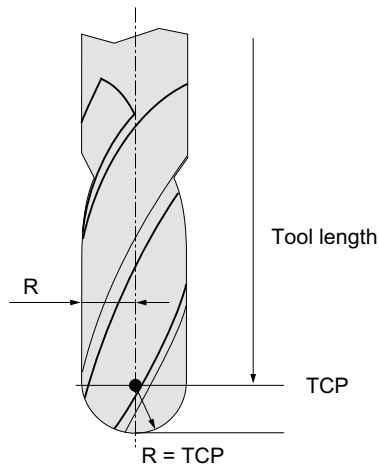





Figure 10-19 The length up to the TCP (Tool Center Point) must be entered as tool length of the radial cutter.

Procedure

1. The part program to be executed has been created and you are in the editor.
2. Press the "Various" softkey.
3. Press the "Swivel tool" and "Setting milling tool" softkeys. The "Setting tool" input window opens.



Parameter	Description	Unit
PL	Plane for milling	
TC	Name of the swivel data record	
Retraction	No	No retraction before swiveling
	ink	Incremental retraction in tool direction The retraction path is entered into parameter ZR.
	max	Maximum retraction in tool direction
	Z	Retraction in the direction of machine axis Z
	Z XY	Retract towards the machine axis Z and then in the direction X, Y
ZR	Retraction path - (only for incremental retraction in the tool direction)	
Axis sequence	Sequence of the axes which are rotated around XY or XZ or YX or YZ or ZX or ZY	
X	Rotation around X	Degrees
Y	Rotation around Y	Degrees

Parameter	Description	Unit
Tool 	Tool tip position when swiveling	
		Tracking The position of the tool tip is maintained during swiveling.
		No tracking The position of the tool tip changes during swiveling.

10.6.3 High-speed settings (CYCLE832)

Function

The "High Speed Settings" function (CYCLE832) is used to preset data for the machining of free-form surfaces so that optimum machining is possible.

The call of CYCLE832 contains three parameters:

- Machining type (technology)
- Axis tolerance
- Input of the orientation tolerance (for 5-axis machines)

Machining of free-form surfaces involves high requirements for both velocity and precision and surface quality.

With the "High Speed Settings" function, you can achieve optimum velocity control depending on the type of machining (roughing, rough-finishing, finishing). For this purpose, the cycle activates the compressor COMPCAD (for Advanced Surface option) or COMPSURF (for TOP Surface option).

Note

Programming a cycle

Program the cycle in the technology program before the geometry program is called.



Software option

To use the "High Speed Settings" (CYCLE832) function, you require the "Advanced Surface" software option.

Default values

You can use the "Default values" softkey to assign default values to the tolerance parameters.



Machine manufacturer

Please observe the information provided by the machine manufacturer.

Surface smoothing

For the "High Speed Settings" (CYCLE832) function, there are two ways in which the surface quality of free-form surfaces can be improved. To smooth the surface, the continuous-path control is optimized within a defined contour tolerance.



Software option

To smooth contours with the "High Speed Settings" (CYCLE832) function, you require the "Top Surface" software option.

Machining methods

You can choose between the following technological machining operations:

- "Finishing"
- "Rough-finishing"
- "Roughing"
- "Deselected" (default setting)

Note

Plain text entry

You can enter the parameters in plain text in the "Machining" selection box. Plain text is generated for the "Machining mode" parameter when the input screen is closed (e.g. `_ROUGH` for roughing).

For CAM programs in the HSC range, the four machining types directly relate to the accuracy and speed of the path contour (see help screen).

The operator/programmer uses the tolerance value to give a corresponding weighting.

Corresponding to the appropriate G commands, the four machining types are assigned to technology G group 59:

Machining type	Technology G group 59
Deselection	DYNNORM
Finishing	DYNFINISH
Rough-finishing	DYNSEMIFIN
Roughing	DYNROUGH

In the "Machine" operating area, the G functions that are active in the part program are shown in the "G functions" window.

Orientation tolerance

You can enter the orientation tolerance for applications on machines with the dynamic multi-axis orientation transformation (TRAORI).

MD note

Additional G commands that are available for use in machining free-form surfaces, are also activated in the High Speed Settings cycle.

When deselecting CYCLE832, the G groups are programmed to the settings - during the program run time - that are declared in the machine data for the reset state.

References

For additional information, please refer to the following documentation:

SINUMERIK Operate Commissioning Manual

Programming Manual, Job Planning

See also



G functions for mold making (Page 211)

Procedure



1. The part program or ShopTurn program to be processed has been created and you are in the editor.
2. Select the "Miscellaneous" softkey.
3. Press the "High Speed Settings" softkey.
The "High Speed Settings" input window is opened.
4. Press the "Default values" softkey if you want to store default values for axis tolerance values depending on the machining.

10.6.3.1 Parameters

Parameter	Description	Unit
Machining 	<ul style="list-style-type: none"> • ▽ (roughing) • ▽▽ (semi-finishing) • ▽▽▽ (finishing) • Deselection 	
Mold-making function 	<ul style="list-style-type: none"> • Advanced Surface • Top Surface <p>Note The field can be hidden. Please observe the information provided by the machine manufacturer.</p>	

Parameter	Description	Unit
Contour tolerance	<ul style="list-style-type: none"> • Input of the maximum allowance from the programmed contour. • Standard default values depending on the type of machining via the "Default values" softkey: <ul style="list-style-type: none"> - ▽ (roughing) 0.100 - ▽▽ (pre-finishing) 0.050 - ▽▽▽ (finishing) 0.010 <p>Note The default values may have been changed by the manufacturer. Please observe the information provided by the machine manufacturer.</p>	
Smoothing (not for "Advanced Surface")	<ul style="list-style-type: none"> • Yes Optimized path within the contour tolerance • No Path close to contour <p>Note The field can be hidden. Please observe the information provided by the machine manufacturer.</p>	
Multi-axis program 	<p>Multi-axis program for 5-axis machines</p> <ul style="list-style-type: none"> • Yes The orientation tolerance > 0 degrees can be entered here • No The value 1 is entered automatically <p>Note The field can be hidden. Please observe the information provided by the machine manufacturer.</p>	
ORI tolerance	<p>Specification of the maximum allowance from the programmed tool orientation (for 5-axis machines).</p>	

10.6.4 Subroutines

If you require the same machining steps when programming different workpieces, you can define these machining steps in a separate subprogram. You can then call this subprogram in any program.

Identical machining steps therefore only have to be programmed once.

A distinction is not made between the main program and subprograms. This means that you can call a "standard" ShopTurn program or G code program in another ShopTurn program as a subprogram.

You can also call another subprogram in the subprogram. The maximum nesting depth is 15 subprograms.

Note

You cannot insert subprograms in linked blocks.

If you want to call a ShopTurn program as a subprogram, the program must already have been calculated once (load or simulate program in the "Machine Auto" mode). This is not necessary for G code subprograms.

Program clipboard

If you use the "Execution from external storage (EES)" software option, the subprogram can be stored locally or externally in an arbitrary program memory configured for EES.

If you use the "CNC user memory extended" software option, the subprogram can be stored on the system CF card in a program memory configured for EES.

Without these two software option, the subprogram must always be stored in the NCK work memory (in a separate "XYZ" directory or in the "Subprograms" directory). If you still want to call a subprogram located on another drive, you can use G code command "EXTCALL".

Program header

Please note that when a subprogram is called, the settings in the program header of the subprogram are evaluated. These settings also remain active even after the subprogram has been exited.

If you wish to activate the settings from the program header for the main program again, you can make the settings again in the main program after calling the subprogram.

Procedure

1. Create a ShopTurn or G code program that you would like to call as a subprogram in another program.
2. Position the cursor in the work plan or in the program view of the main program on the program block after which you wish to call the subprogram.
3. Press the "Various" and "Subprogram" softkeys.



4. Enter the path of the subprogram if the desired subprogram is not stored in the same directory as the main program.

10.6 Further cycles and functions

5. Enter the name of the subprogram that you want to insert.
You only need to enter the file extension (*.mpf or *.spf) if the subprogram does not have the file extension specified for the directory in which the subprogram is stored.



6. Press the "Accept" softkey.
The subprogram call is inserted in the main program.

Parameter	Description
Path/workpiece	Path of the subprogram if the desired subprogram is not stored in the same directory as the main program.
Program name	Name of the subprogram that is to be inserted.

Programming example

```

N10 T1 D1 ;Load tool
N11 M6
N20 G54 G710 ;Select work offset
N30 M3 S12000 ;Switch-on spindle
N40 CYCLE832(0.05,3,1) ;Tolerance value 0.05 mm, machining type,
roughing
N50 EXTCALL"CAM_SCHRUPP" Externally call subprogram CAM_SCHRUPP
N60 T2 D1 ;Load tool
N61 M6
N70 CYCLE832(0.005,1,1) ;Tolerance value 0.005 mm, machining
type, finishing
N80 EXTCALL"CAM_SCHLICHT" ;Call subprogram CAM_SCHLICHT
N90 M30 ;End of program
    
```

The subprograms CAM_SCHRUPP.SPF, CAM_SCHLICHT.SPF contain the workpiece geometry and the technological values (feedrates). These are externally called due to the program size.

10.7 Additional cycles and functions in ShopTurn

10.7.1 Drilling centric

Function

Using the "Drill centric" cycle, you can perform drilling operations at the center of a face surface.

You can choose between chip breaking during drilling or retraction from the workpiece for swarf removal. During machining, either the main spindle or counterspindle rotates. You can use a drill, rotary drill or milling cutter as the tool.

The tool is moved with rapid traverse to the programmed position, allowing for the return plane and safety clearance.

Note

Working with rotating tool spindle

For example, if you want to drill very deep holes, you can also employ a rotating tool spindle. First specify the required tool and tool spindle speed under "Straight/Circle" → "Tool". Then program the "Drill centered" function.

Note

Stop tool spindle

If, during "Center drilling", the tool spindle does not rotate despite having been previously activated, then program the "M5" G code command before "Center drilling" in order to stop the tool spindle.

Input simple

For simple machining operations, you have the option to reduce the wide variety of parameters to the most important parameters using the "Input" selection field. In this "Input simple" mode, the hidden parameters are allocated a fixed value that cannot be adjusted.



Machine manufacturer

Various defined values can be pre-assigned using setting data.

Please refer to the machine manufacturer's specifications.

If the workpiece programming requires it, you can display and change all of the parameters using "Input complete".

Approach/retraction during chipbreaking

1. The tool drills at the programmed feedrate F as far as the first infeed depth.
2. For chipbreaking, the tool retracts by the retraction value V2 and drills as far as the next infeed depth that can be reduced by the factor DF.
3. Step 2 is repeated until final drilling depth Z1 has been reached and dwell time DT has expired.
4. The tool retracts to the safety clearance with rapid traverse.

Approach/retraction during stock removal

1. The tool drills at the programmed feedrate F as far as the first infeed depth.
2. The tool is retracted from the workpiece with rapid traverse to the safety clearance for stock removal and is then re-inserted at the first infeed depth in the automatic mode reduced by an anticipation distance calculated by the control system.
3. The tool then drills down to the next infeed depth that can be reduced by the factor DF and the tool retracts again to Z0 + safety clearance for stock removal.
4. Step 3 is repeated until final drilling depth Z1 has been reached and dwell time DT has expired.
5. The tool retracts to the safety clearance with rapid traverse.





Procedure



1. The ShopTurn program to be edited has been created and you are in the editor.
2. Press the "Drilling" and "Drill centric" softkeys.
The "Drilling centered" input window opens.





Parameters in the "Input complete" mode

Parameter	Description	Unit
Input	Complete	
T	Tool name	
D	Cutting edge number	
F	Feedrate	mm/min mm/rev
S / V	Spindle speed or constant cutting rate	rpm m/min
Machining	<ul style="list-style-type: none"> • Chipbreaking • Swarf removal 	

Parameter	Description	Unit
Z0	Reference point Z (abs)	
Drilling depth 	Referred to <ul style="list-style-type: none"> • Shank The drill is inserted until the drill shank reaches the value programmed for Z1. The angle entered in the tool list is taken into account. • Tip The drill is inserted until the drill tip reaches the value programmed for Z1. 	
Z1 	Final drilling depth (abs) or final drilling depth in relation to Z0 (inc)	
D	Maximum depth infeed	
FD1	Percentage for the feedrate for the first infeed	%
DF 	<ul style="list-style-type: none"> • Percentage for each additional infeed or • Amount for each additional infeed DF = 100: Infeed increment remains constant DF < 100: Infeed increment is reduced in direction of final drilling depth. Example: DF = 80 Last infeed was 4 mm; 4 x 80% = 3.2; next infeed increment is 3.2 mm 3.2 x 80% = 2.56; next infeed increment is 2.56 mm, etc.	% mm
V1	Minimum depth infeed Parameter V1 is available only if DF<100% has been programmed. A minimum infeed is programmed using parameter V1.	
V2	Retraction distance after each machining step – (only for "chipbreaking" operation)	
Clearance distance 	- (only for "swarf removal" operation) <ul style="list-style-type: none"> • Manual • Automatic 	
V3	Clearance distance – (for "manual" clearance distance only)	
DT 	<ul style="list-style-type: none"> • Dwell time in seconds • Dwell time in revolutions 	s rev
XD	Center offset in X direction The center offset can be used for example to produce a drill hole with an exact fit. A rotary drill (rotary drill type) or U drill (drill type) is required. Other drill types are not suitable. The maximum center offset is stored in a machine data code.	mm

Parameters in the "Input simple" mode

Parameter	Description	Unit
Input	simple	
T	Tool name	
D	Cutting edge number	

Parameter	Description	Unit
F 	Feedrate	mm/min mm/rev
S / V 	Spindle speed or constant cutting rate	rpm m/min
Machining 	<ul style="list-style-type: none"> • Chipbreaking • Swarf removal 	
Z0	Reference point Z	
Z1 	Final drilling depth X (abs) or final drilling depth in relation to Z0 (inc)	
D	Maximum depth infeed	
XD	<p>Center offset in X direction</p> <p>The center offset can be used for example to produce a drill hole with an exact fit. A rotary drill (rotary drill type) or U drill (drill type) is required. Other drill types are not suitable.</p> <p>The maximum center offset is stored in a machine data code.</p>	mm

Hidden parameters

Parameter	Description	Value	Can be set in SD
Drilling depth	Drilling depth in relation to the tip	Tip	
FD1	Percentage for the feedrate for the first infeed	90 %	x
DF	Percentage for each additional infeed	90 %	x
V1	Minimum infeed	1.2 mm	x
V2	Retraction distance after each machining step	1.4 mm	x
Clearance distance	The clearance distance is calculated by the cycle	Automatic	x
DBT	Dwell time at drilling depth	0.6 s	x
DT	Dwell time at final drilling depth	0.6 s	



Machine manufacturer

Please refer to the machine manufacturer's specifications.

10.7.2 Thread centered

Function

Using the "Centered tapping" cycle, tap a righthand or lefthand thread at the center of the face surface.

During machining, either the main spindle or counterspindle rotates.
You can alter the spindle speed via the spindle override; feedrate override is not operative.

You can select drilling in one cut, chipbreaking or retraction from the workpiece for stock removal.

The tool is moved with rapid traverse to the programmed position, allowing for the retraction plane and safety clearance.

Approach/retraction in one cut

1. The tool drills in the direction of the longitudinal axis at the programmed spindle speed S or cutting rate V as far as the final drilling depth Z1.
2. The direction of rotation of the spindle reverses and the tool retracts to the safety clearance at the programmed spindle speed SR or cutting rate VR.

Approach/retraction for stock removal

1. The tool drills in the direction of the longitudinal axis at the programmed spindle speed S or feedrate V as far as the first infeed depth (maximum infeed depth D).
2. The tool retracts from the workpiece to the safety clearance at spindle speed SR or cutting rate VR for stock removal.
3. Then the tool is inserted again at spindle speed S or feedrate V and drills to the next infeed depth.
4. Steps 2 and 3 are repeated until the programmed final drilling depth Z1 is reached.
5. The direction of rotation of the spindle reverses and the tool retracts to the safety clearance at spindle speed SR or cutting rate VR.

Approach/retraction for chipbreaking

1. The tool drills in the direction of the longitudinal axis at the programmed spindle speed S or feedrate V as far as the first infeed depth (maximum infeed depth D).
2. The tool retracts by the retraction clearance V2 for chipbreaking.
3. The tool then drills to the next infeed depth at spindle speed S or feedrate V.
4. Steps 2 and 3 are repeated until the programmed final drilling depth Z1 is reached.
5. The direction of rotation of the spindle reverses and the tool retracts to the safety clearance at spindle speed SR or cutting rate VR.

The machine manufacturer may have made specific settings for centered tapping in a machine data element.



Machine manufacturer

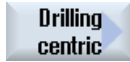

Please refer to the machine manufacturer's specifications.

Procedure



1. The ShopTurn program to be processed has been created and you are in the editor.
2. Press the "Drilling" and "Drill centric" and "Thread centric" softkeys. The "Centric tapping" input window opens.

Parameters	Description	Unit
T	Tool name	
D	Cutting edge number	
F	Feedrate	mm/min mm/rev
Table	Thread table selection: <ul style="list-style-type: none"> • without • ISO metric • Whitworth BSW • Whitworth BSP • UNC 	
Selection	Selection, table value: <ul style="list-style-type: none"> • M1 - M68 (ISO metric) • W3/4"; etc. (Whitworth BSW) • G3/4"; etc. (Whitworth BSP) • 1" - 8 UNC; etc. (UNC) 	
P - (selection only possible for table selection "without")	Pitch ... <ul style="list-style-type: none"> • in MODULUS: MODULUS = Pitch/π • in mm/rev • in inch/rev • in turns per inch: Used with pipe threads, for example. When entered per inch, enter the integer number in front of the decimal point in the first parameter field and the figures after the decimal point as a fraction in the second and third field. The pitch is determined by the tool used.	MODULUS mm/rev in/rev turns/"
S / V	Spindle speed or constant cutting rate	rpm m/min
SR	Spindle speed for retraction	rev/min
VR	Constant cutting rate for retraction	m/min

Parameters	Description	Unit
Machining 	<ul style="list-style-type: none"> • 1. Cut The thread is drilled in one cut without interruption. • Chipbreaking The drill is retracted by the retraction distance V2 for chipbreaking. • Stock removal The drill is retracted from the workpiece for stock removal. 	
Z0	Reference point Z)	mm
Z1 	End point of the thread (abs) or thread length (inc)	mm
D	Maximum depth infeed - (for stock removal or chipbreaking only)	mm
Retraction 	- (only for "chipbreaking" operation) Retraction distance <ul style="list-style-type: none"> • Manual • Automatic 	
V2	Retraction distance (only for "manual" retraction) Distance through which the tap is retracted for chipbreaking. V2 = automatic: The tool is retracted by one revolution.	mm

10.7.3 Transformations

To make programming easier, you can transform the coordinate system. Use this possibility, for example, to rotate the coordinate system.

Coordinate transformations only apply in the actual program.

You can define the following transformations:

- Offset
- Rotation
- Scaling
- Mirroring
- Rotation C axis

You can select between a new or an additive coordinate transformation.

In the case of a new coordinate transformation, all previously defined coordinate transformations are deselected. An additive coordinate transformation acts in addition to the currently selected coordinate transformations.

The transformation refers to the current machining surface (turning, face ..., peripheral ...). Therefore it must be selected prior to the transformation (e.g. with Straight/Circle => Tool).









Note

Transformations with virtual axes

Please note that when selecting TRANSMIT or TRACYL offsets, scaling and mirroring, the real Y axis is not transferred into the virtual Y axis.

Offsets, scalings and mirroring of the virtual Y axis are deleted for TRAF00F.

Procedure for work offset, offset, rotation, scaling, mirroring or rotation C axis.

1. The ShopTurn program has been created and you are in the editor.
2. Press the "Various" and "Transformation" softkeys.
 
3. Press the "Work offsets" softkey.
The "Work offsets" input window opens.
- OR -
Press the "Offset" softkey.
The "Offset" input window opens.
- OR -
Press the "Rotation" softkey.
The "Rotate" input window opens.
- OR -
Press the "Scaling" softkey.
The "Scaling" input window opens.
- OR -
Press the "Mirroring" softkey.
The "Mirroring" input window opens.
- OR -
Press the "Rotation C axis" softkey.
The "Rotation C axis" input window opens.
     

10.7.4 Translation

For each axis, you can program an offset of the zero point.

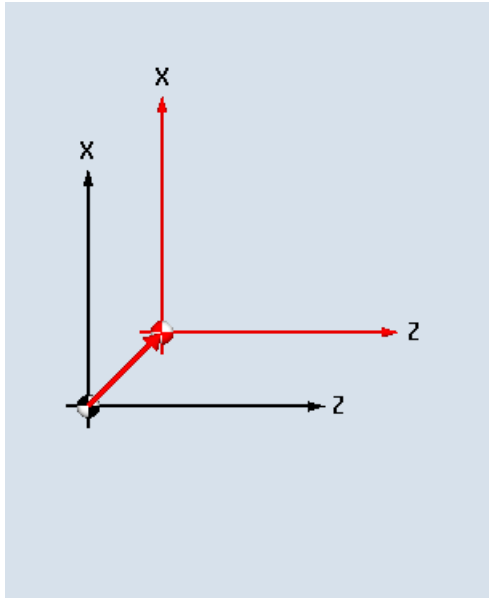

New offset

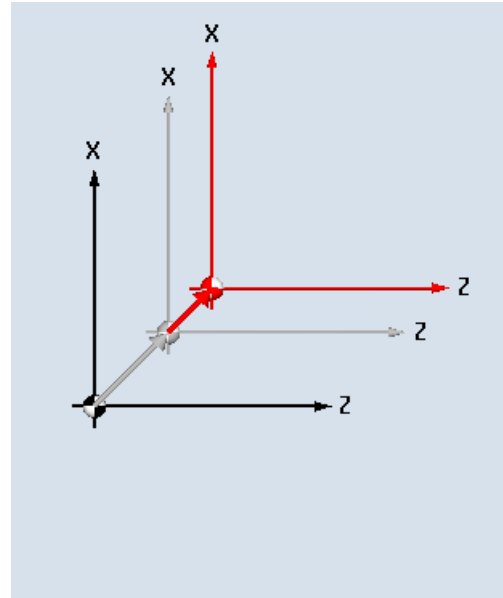

Additive offset

Parameter	Description	Unit
Offset U	<ul style="list-style-type: none"> New New offset Additive Additive offset 	
Z	Offset Z	mm
X	Offset X	mm
Y	Offset Y	mm

10.7.5 Rotation

You can rotate every axis through a specific angle. A positive angle corresponds to counterclockwise rotation.

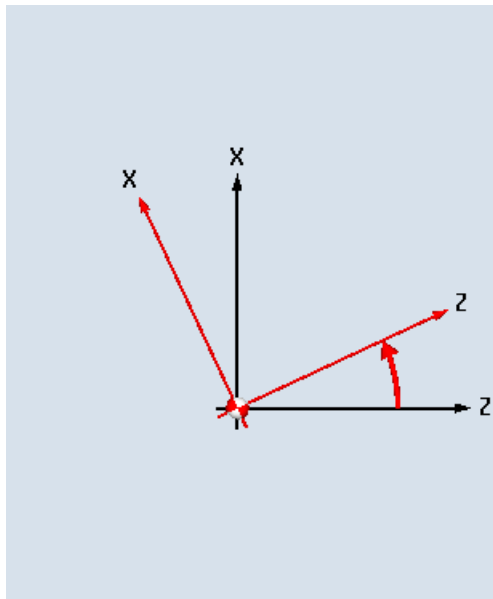

New rotation

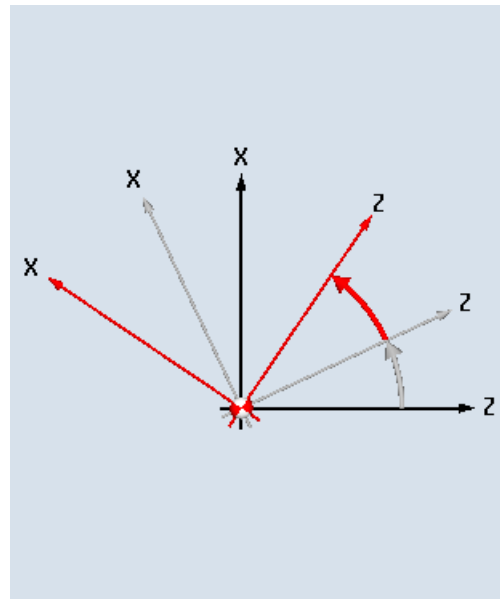

Additive rotation

Parameter	Description	Unit
Rotation 	<ul style="list-style-type: none"> • New • New rotation 	
Z	Rotation around Z	Degrees
X	Rotation around X	Degrees
Y	Rotation around Y	Degrees

10.7.6 Scaling

You can specify a scale factor for the active machining plane as well as for the tool axis. The programmed coordinates are then multiplied by this factor.

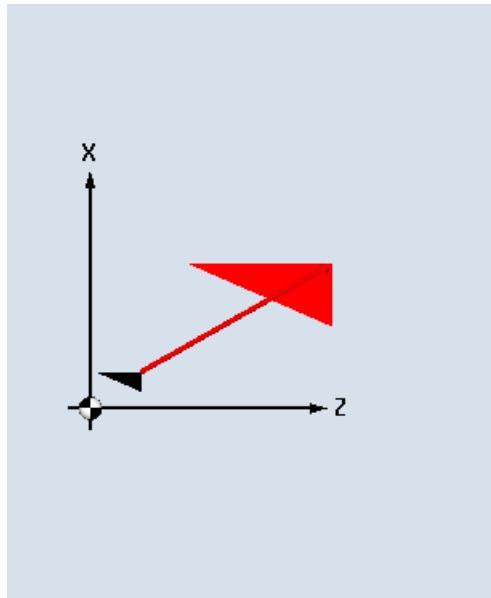

New scaling

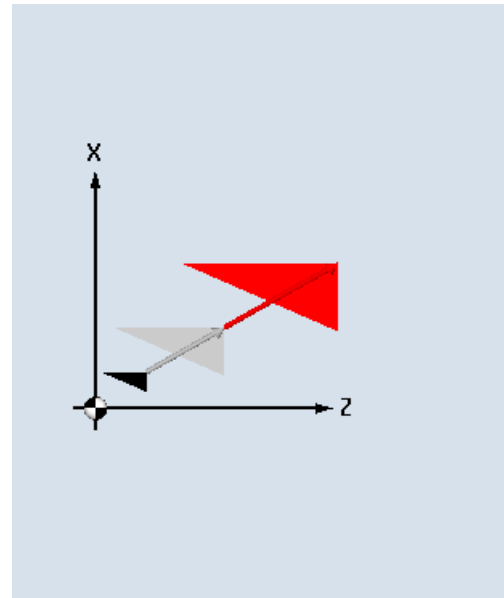

Additive scaling

Parameter	Description	Unit
Scaling 🔵	<ul style="list-style-type: none"> • New New scaling • Additive Additive scaling 	
ZX	Scale factor ZX	
Y	Scale factor Y	

10.7.7 Mirroring

Furthermore, you can mirror all axes. Enter the axis to be mirrored in each case.

Note

Travel direction of the milling cutter



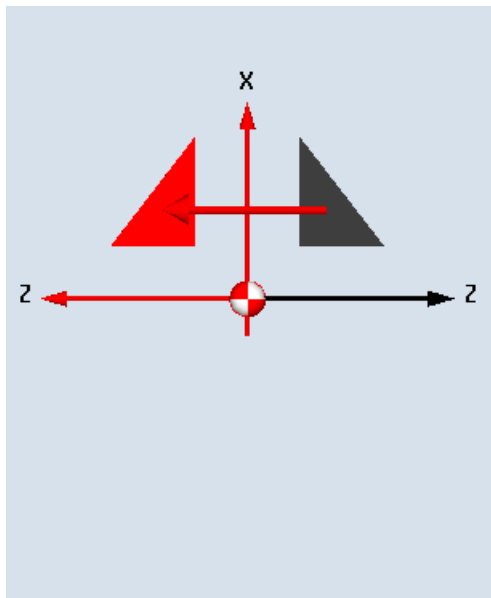

Note that with mirroring, the travel direction of the cutting tool (conventional/climb) is also mirrored.

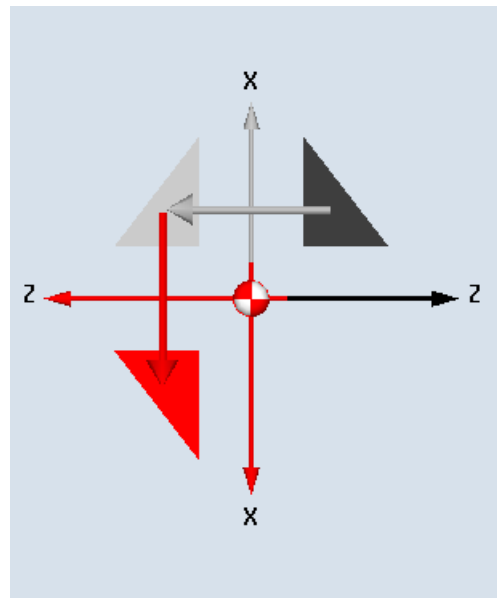

New mirroring



Additive mirroring

Parameter	Description	Unit
Mirroring 	<ul style="list-style-type: none"> • New New mirroring • Additive Additive mirroring 	
Z 	Mirroring of the Z axis, on/off	
X 	Mirroring of the X axis, on/off	
Y 	Mirroring of the Y axis, on/off	

10.7.8 Rotation C

You can rotate the C axis through a specific angle to enable subsequent machining operations to be performed at a particular position on the face or peripheral surface.

The direction of rotation is set in a machine data element.



Machine manufacturer

Please refer to the machine manufacturer's specifications.

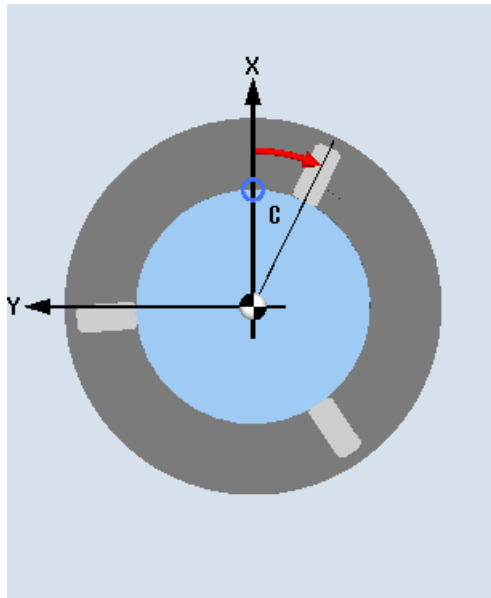

New C axis rotation

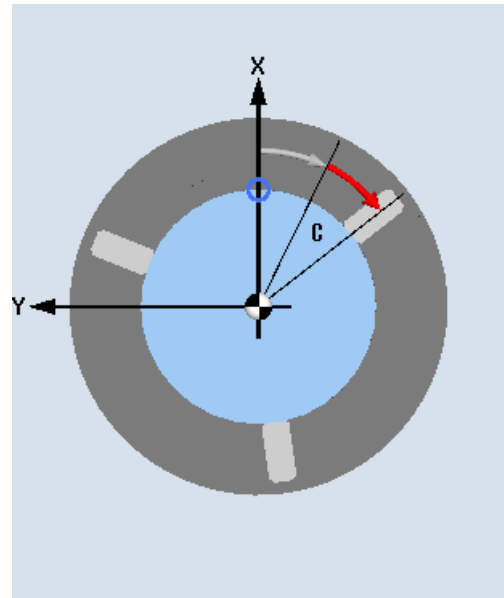

Additive C axis rotation

Parameter	Description	Unit
Rotation ⌚	<ul style="list-style-type: none"> New New rotation Additive Additive rotation 	
C	Rotation C	Degrees

10.7.9 Straight and circular machining

If you want to perform simple, i.e. straight or circular path movements or machining without defining a complete contour, you can use the functions "Straight" or "Circle" respectively.

General sequence

To program simple machining operations, proceed as follows:

- Specify the tool and the spindle speed
- Program the machining operations

Machining options

The following machining options are available:

- Straight line
- Circle with known center point
- Circle with known radius

- Straight line with polar coordinates
- Circle with polar coordinates

If you want to program a straight line or a circle using polar coordinates, you must define the pole first.

NOTICE
Risk of collision
If you retract the tool to the retraction area defined in the program header using either straight or circular path motion, then you must carefully ensure that a collision cannot occur as a result of the normal retraction logic.
To be on the safe side, you should also move the tool back out of the retraction area again.

10.7.10 Selecting a tool and machining plane

Before you can program a line or circle, you have to select the tool, spindle, spindle speed and machining plane.

If you program a sequence of different straight or circular path motions, the settings for the tool, spindle, spindle speed and machining plane remain active until you change them again.

If you change the selected machining plane subsequently, the coordinates of the programmed path motion are automatically adjusted to the new machining plane. The originally programmed coordinates remain unchanged only for a straight motion (right-angled, not polar).

Procedure



1. The ShopTurn program to be processed has been created and you are in the editor.



2. Press the menu forward key and the "Straight Circle" softkey.



3. Press the "Tool" softkey.
The "Tool" window is opened.

4. Enter a tool into parameter field "T".
- OR -



Press the "Select tool" softkey if you want to select a tool from the tool list, position the cursor on the tool that you wish to use for the machining operation and press the "To program" softkey.
The tool is copied into the "T" parameter field.

5. Select the tool cutting edge number D if the tool has several cutting edges.

6. In the lefthand input field of the Spindle parameter, select main spindle, tool spindle or counterspindle.
7. Enter the spindle speed or cutting rate.
8. In the selection box "Plane selection", select between the machining planes.
9. Enter the cylinder diameter if you selected the machining plane peripheral surface C.
- OR -
Enter the positioning angle for the CP machining area if you selected machining plane face Y.
- OR -
Enter reference point C0 if you selected the machining plane peripheral surface Y.
- OR -
Choose whether the spindle should be clamped or released or whether there should be no change (input field left blank).
Press the "Accept" softkey.
The values are saved and the window is closed. The process plan is displayed and the newly generated program block is marked.



Parameter	Description	Unit
T	Tool name	
D	Cutting edge number	
S1 / V1	Spindle speed or constant cutting rate	rpm m/min
Plane selection	Select between the following machining surfaces: <ul style="list-style-type: none"> • Peripheral surface/Peripheral C • Peripheral surface Y - only if there is a Y axis • Face/Face C • Face Y - only if there is a Y axis • Turning 	
∅	Diameter of the cylinder (for peripheral surface/peripheral C)	mm
C0	Positioning angle for machining area (for peripheral surface Y)	Degrees
CP	Positioning angle for machining area (for face Y) Angle CP does not have any effect on the machining position in relation to the work-piece. It is only used to position the workpiece with the rotary axis C in such a way that machining is possible on the machine.	Degrees

10.7.11 Programming a straight line

When you want to program a straight line in right-angled coordinates, you can use the "Straight" function.

The tool moves along a straight line at the programmed feedrate or at rapid traverse from its actual position to the programmed end position.

Radius compensation

Alternately, you can implement the straight line with radius compensation. The radius compensation acts modally, therefore you must deactivate the radius compensation again when you want to traverse without radius compensation. Where several straight line blocks with radius compensation are programmed sequentially, you may select radius compensation only in the first program block.

When executing the first path motion with radius compensation, the tool traverses without compensation at the starting point and with compensation at the end point. This means that if a vertical path is programmed, the tool traverses an oblique path. The compensation is not applied over the entire traversing path until the second programmed path motion with radius compensation is executed. The reverse effect occurs when radius compensation is deactivated.

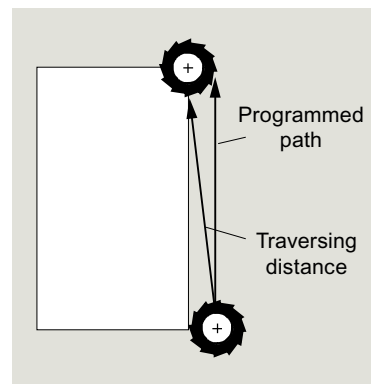
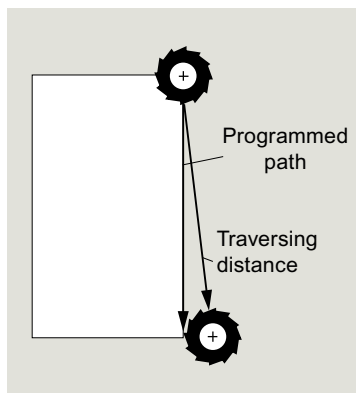

Straight line when selecting radius compensation Straight line when deselecting radius compensation

If you want to prevent deviation from the programmed path, you can program the first straight line with radius compensation or with deactivated radius compensation outside the workpiece. Programming without coordinate data is not possible.

















Procedure



1. The ShopTurn program to be processed has been created and you are in the editor.
2. Press the menu forward key and the "Straight Circle" softkey.



3. Press the "Straight" softkey.
4. Press the "Rapid traverse" softkey if you want to use rapid traverse instead of a programmed machining feedrate.

Parameters	Description	Unit
X 	Target position X \emptyset (abs) or target position X referred to the last programmed position (inc)	mm
Y 	Target position Y (abs) or target position Y referred to the last programmed position (inc)	mm
Z 	Target position Z (abs) or target position Z referred to the last programmed position (inc)	mm
U 	Target position (abs) or target position referred to the actual position (inc)	mm
C 	Target angle (abs) or target angle referred to the actual position (inc)	Degrees
C1 	Target position of C axis of main spindle (abs or inc)	mm
C3 	Target position of C axis of counterspindle (abs or inc)	mm
Z3 	Target position of special axis (abs or inc) Note: Incremental dimension: The sign is also evaluated.	mm
AWZ 	Target angle (abs) or target angle referred to the actual position (inc)	Degrees
GS 	Target angle (abs) or target angle referred to the actual position (inc)	Degrees
F 	Machining feedrate Alternatively, rapid traverse	mm/rev mm/min mm/tooth
Radius compensation 	Input defining which side of the contour the cutter travels in the traversing direction:	
	 Radius compensation to right of contour	
	 Radius compensation to left of contour	
	 Radius compensation off	
	 The previously programmed setting for radius compensation is used.	

10.7.12 Programming a circle with known center point

To program a circle or arc with a known center point, use the "Circle center point" function.

The tool traverses a circular path from its actual position to the programmed target position at the machining feedrate. The system calculates the radius of the circle/arc on the basis of the entered interpolation parameter settings I and K.







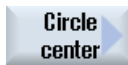

Procedure







1. The ShopTurn program to be processed has been created and you are in the editor.
2. Press the menu forward key and the "Straight Circle" softkey.



3. Press the "Circle center point" softkey.

Parameters	Description	Unit
Direction of rotation	Direction of rotation in which the tool travels from the circle starting point to the circle end point:	
	 Direction of rotation clockwise (right)	
	 Direction of rotation counterclockwise (left)	
Y  Z  J K	Machining plane, peripheral surface C Target position Y (abs) or target position X referred to the last programmed position (inc) Target position Z (abs) or target position Y referred to the last programmed position (inc) Circle center point J (ink). Circle center point K (inc). Note: Incremental dimension: The sign is also evaluated.	mm mm mm
Y  Z  J K	Machining plane, peripheral surface Y Target position Y (abs) or target position X referred to the last programmed position (inc) Target position Z (abs) or target position Y referred to the last programmed position (inc) Circle center point J (ink). Circle center point K (inc) Note: Incremental dimension: The sign is also evaluated.	mm mm mm
X  Y  I J	Machining plane face C Target position X \varnothing (abs) or target position X referred to the last programmed position (inc) Target position Y (abs) or target position Y referred to the last programmed position (inc) Circle center point I (ink) Circle center point J (inc) Note: Incremental dimension: The sign is also evaluated.	mm mm mm

Parameters	Description	Unit
X  Y  I J	Machining plane face Y Target position X (abs) or target position X referred to the last programmed position (inc) Target position Y (abs) or target position Y referred to the last programmed position (inc) Circle center point I (inc). Circle center point J (inc). Note: Incremental dimension: The sign is also evaluated.	mm mm mm mm
X  Z  I K	Machining plane rotation Target position X \emptyset (abs) or target position Y referred to the last programmed position (inc) Target position Z (abs) or target position X referred to the last programmed position (inc) Circle center point I (inc). Circle center point K (inc) Note: Incremental dimension: The sign is also evaluated.	mm mm mm mm
F 	Machining feedrate	mm/rev mm/min mm/tooth

10.7.13 Programming a circle with known radius

To program a circle or arc with a known radius, use the "Circle radius" function.

The tool traverses a circular arc with the programmed radius from its actual position to the programmed target position at the machining feedrate. To do this, the system calculates the position of the circle center point.

You can choose to traverse the arc in the clockwise or anticlockwise direction. Depending on the direction of rotation, there are two options for approaching the target position from the current position via an arc of the specified radius.

You can select the arc of your choice by entering a positive or a negative sign for the radius.

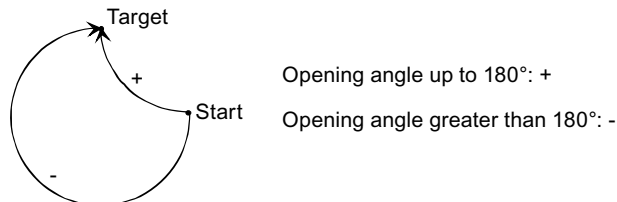















Figure 10-20 Opening angle

Procedure



1. The ShopTurn program to be processed has been created and you are in the editor.
2. Press the menu forward key and the "Straight Circle" softkey.
3. Press the "Circle radius" softkey.

Parameters	Description	Unit
Direction of rotation	Direction of rotation in which the tool travels from the circle starting point to the circle end point	
	 Direction of rotation clockwise (right)	
	 Direction of rotation counterclockwise (left)	
Y  Z 	<p>Machining plane peripheral surface/peripheral surface C</p> <p>Target position Y (abs) or target position X referred to the last programmed position (inc)</p> <p>Target position Z (abs) or target position Y referred to the last programmed position (inc)</p> <p>Note: Incremental dimension: The sign is also evaluated</p>	mm mm
Y  Z 	<p>Machining plane, peripheral surface Y</p> <p>Target position Y (abs) or target position X referred to the last programmed position (inc)</p> <p>Target position Z (abs) or target position Y referred to the last programmed position (inc)</p> <p>Note: Incremental dimension: The sign is also evaluated.</p>	mm mm
X  Y 	<p>Machining plane face/face C</p> <p>Target position X (abs) or target position X referred to the last programmed position (inc)</p> <p>Target position Y (abs) or target position Y referred to the last programmed position (inc)</p> <p>Note: Incremental dimension: The sign is also evaluated</p>	mm mm
X  Y 	<p>Machining plane face Y</p> <p>Target position X (abs) or target position X referred to the last programmed position (inc)</p> <p>Target position Y (abs) or target position Y referred to the last programmed position (inc)</p> <p>Note: Incremental dimension: The sign is also evaluated.</p>	mm mm

Parameters	Description	Unit
X  Z 	<p>Machining plane rotation</p> <p>Target position X \emptyset (abs) or target position Y referred to the last programmed position (inc)</p> <p>Target position Z (abs) or target position X referred to the last programmed position (inc)</p> <p>Note: Incremental dimension: The sign is also evaluated.</p>	mm mm
R	<p>Radius of circular arc</p> <p>The sign determines the type of arc traversed.</p>	mm mm
F 	Machining feedrate.	mm/rev mm/min mm/tooth

10.7.14 Polar coordinates

If a workpiece has been dimensioned from a central point (pole) with radius and angles, you will find it helpful to program these dimensions as polar coordinates.

Before you program a straight line or circle in polar coordinates, you must define the pole, i.e. the reference point, of the polar coordinate system.

Procedure

1. The ShopTurn program to be processed has been created and you are in the editor.
2. Press the menu forward key and the "Straight Circle" softkey.



3. Press the "Polar" and "Pole" softkeys.



Parameters	Description	Unit
Y Z	Machining plane peripheral surface/peripheral surface C Pole Y (abs) Pole Z (abs) or pole Z referred to the last programmed position (inc) Note: Incremental dimension: The sign is also evaluated.	mm mm
Y Z	Machining plane, peripheral surface Y Pole Y (abs) Pole Z (abs) or pole Z referred to the last programmed position (inc) Note: Incremental dimension: The sign is also evaluated.	mm mm
X Y	Machining plane face/face C Pole X \varnothing (abs) Pole Y (abs) or pole Y referred to the last programmed position (inc) Note: Incremental dimension: The sign is also evaluated.	mm mm
X Y	Machining plane face Y Pole X (abs) Pole Y (abs) or pole Y referred to the last programmed position (inc) Note: Incremental dimension: The sign is also evaluated.	mm mm
X Z	Machining plane rotation Pole X (abs) or pole X referred to the last programmed position (inc) Z position pole (abs) Note: Incremental dimension: The sign is also evaluated.	mm mm

10.7.15 Straight line polar

When you want to program a straight line in polar coordinates, you can use the "Straight Polar" function.

A straight line in the polar coordinate system is defined by the length L and the angle α . Depending on the selected machining plane, the angle refers to another axis. The direction in which a positive angle points also depends on the machining plane.

Machining plane	Turning	Face	Peripheral
Reference axis for angle	Z	X	Y
Positive angle in direction of the axis	X	Y	Z

The tool traverses a straight line from its current position to the programmed end point at the machining feedrate or at rapid traverse.

The 1st line in polar coordinates entered after the pole must be programmed in absolute dimensions. You can program any additional lines or arcs also in incremental dimensions.

Radius compensation

Alternately, you can implement the straight line with radius compensation. The radius compensation acts modally, therefore you must deactivate the radius compensation again when you want to traverse without radius compensation. Where several straight line blocks with radius compensation are programmed sequentially, you may select radius compensation only in the first program block.

For the first straight line with radius compensation, the tool approaches the starting point without radius compensation and the end point with radius compensation, i.e. if a vertical path is programmed, a slope will be traversed. The compensation does not act over the entire traverse path until the second programmed straight line with radius compensation. The reverse effect occurs when radius compensation is deactivated.

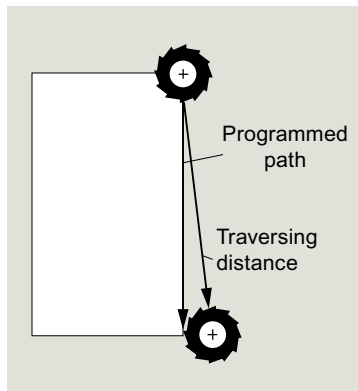

Straight line with selected radius compensation

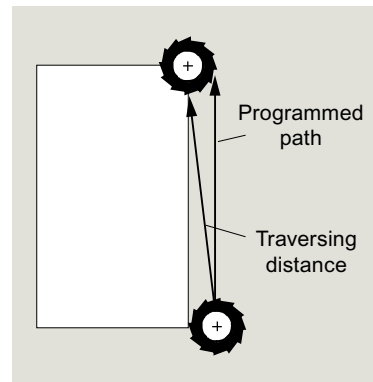







Straight line with deselected radius compensation

If you want to prevent deviation from the programmed path, you can program the first straight line with radius compensation or with deactivated radius compensation outside the workpiece. Programming without coordinate data is not possible.

Procedure



1. The ShopTurn program to be processed has been created and you are in the editor.
2. Press the menu forward key and the "Straight Circle" softkey.
3. Press the "Polar" and "Straight Polar" softkeys.
4. Press the "Rapid traverse" softkey if you want to use rapid traverse instead of a programmed machining feedrate.

Parameters	Description	Unit
L	Distance to the pole, end point	mm
α 	Polar angle to the pole, end point (abs) or Polar angle change to the pole, end point (inc) The sign specifies the direction.	Degrees
F 	Machining feedrate	mm/rev mm/min mm/tooth
Radius compensation 	Input defining which side of the contour the cutter travels in the traversing direction:	
	 Radius compensation to left of contour	
	 Radius compensation to right of contour	
	 Radius compensation off	
	 The set radius compensation remains as previously set	

10.7.16 Circle polar

If you want to program a circle or arc using polar coordinates, you can use the "Circle Polar" function.

A circle in the polar coordinate system is defined by the angle α . Depending on the selected machining plane, the angle refers to another axis. The direction in which a positive angle points also depends on the machining plane.

Machining plane	Rotate	Face	Peripheral
Reference axis for angle	Z	X	Y
Positive angle in direction of the axis	X	Y	Z

The tool traverses a circular path from its actual position to the programmed end point (angle) at the machining feedrate. The radius is obtained from the distance between the actual tool position and the defined pole, i.e. the circle start and end point positions are at the same distance from the pole.

The 1st arc in polar coordinates entered after the pole must be programmed in absolute dimensions. You can program any additional lines or arcs also in incremental dimensions.





Procedure

1. The ShopTurn program to be processed has been created and you are in the editor.
2. Press the menu forward key and the "Straight Circle" softkey.



3. Press the "Polar" and "Circle Polar" softkeys.



Parameters	Description	Unit
Direction of rotation 	Direction of rotation in which the tool travels from the circle starting point to the circle end point	
	 Direction of rotation clockwise (right)	
	 Direction of rotation counterclockwise (left)	
α 	Polar angle to the pole, end point (abs) or Polar angle change to the pole, end point (inc) The sign specifies the direction.	Degrees
F 	Machining feedrate	mm/rev mm/min mm/tooth

10.7.17 Machining with movable counterspindle

If your lathe has a counter-spindle, you can machine workpieces using turning, drilling and milling functions on the front and rear faces without reclamping the workpiece manually.

You have the possibility to start the machining in the main spindle or in the counter-spindle. Prior to machining the associated front or rear side, the workpiece is gripped by the counter-spindle or the main spindle, withdrawn from the main spindle or counter-spindle and travels to the new machining position. You can program these operations with the "Counter-spindle" function.

Operations

The following steps are available to program the operations:

- Gripping: Gripping the workpiece with the counter-spindle or main spindle (possibly with limit stop)
- Withdrawing: Withdrawing a workpiece with the counter-spindle from the main spindle or with the main spindle from the counter-spindle
- Counter-spindle machining side: Traverse workpiece with the counter-spindle or main spindle to a new machining position; select work offset for the machining side
- Complete transfer: Gripping, withdrawing (possibly with cutting-off) and machining side
- Main spindle machining side: Work offset for machining the next front face (for bars)

If you start to execute a program containing a counter-spindle machining operation, the counter-spindle is first retracted to the return position defined in a machine data element.









Machine manufacturer

Please refer to the machine manufacturer's specifications.

Teaching in the parking position and angle offset

Teaching the park position is possible only if you have selected the machine coordinate system (MCS).

- | | |
|--|--|
| 



 | <ol style="list-style-type: none"> 1. Manually rotate the counter-spindle chuck to the desired position, and move the tool to the desired position. 2. Press the "Various" and "Counter-spindle" softkeys. 3. Select the "Gripping" or "Complete transfer" programming step. 4. Select the "MCS" tool under the park position. 5. Press the "Teach park pos." softkey.
The actual tool park position is saved. 6. Press the "Teach angl. offset" softkey.
The actual angular difference between the main and counter-spindles will be saved. |
|--|--|

10.7.17.1 Programming example: Machining main spindle – Transfer workpiece – Machining counterspindle

The programming for this operation might look like this:

Programming steps - alternative 1:

- Machining, main spindle
- Gripping
- Withdrawing
- Counter-spindle machining side
- Machining, counter-spindle

Programming steps - alternative 2:

- Machining, main spindle
- Counter-spindle complete transfer (gripping, withdrawing and machining side)
- Machining, counter-spindle

10.7.17.2 Programming example: Machining counter-spindle – Transfer workpiece – Machining main spindle

The programming for this operation might look like this:

Programming steps - alternative 1:

- Machining, counter-spindle
- Gripping
- Machining side
- Machining, main side

Programming steps - alternative 2:

- Machining, counter-spindle
- Complete transfer (gripping and machining side)
- Machining, main spindle

10.7.17.3 Programming example: Machining, counterspindle - without previous transfer

Programming steps

- Rear face
 - Work offset
Work offset is only activated
 - ZV:
Parameter is not evaluated.
- Machining, counterspindle

Note

Special feature regarding "rear face":

The work offset that you choose in the parameter screen is only activated and not calculated. This means that the workpiece zero for counterspindle machining should be stored in the work offset. In addition, parameter ZV is not evaluated.

10.7.17.4 Programming example: Machining bar material

If you use bars to produce your workpieces, you can machine several workpieces on the front and rear face by starting the program just once.

Programming steps - alternative 1:











- Program header specifying the work offset in which the workpiece zero is stored
- Machining, main spindle
- Complete transfer (withdraw blank: yes; cutting-off cycle: yes)
- Cutting-off
- Machining, counter-spindle
- End of program with number of workpieces to be machined





Programming steps - alternative 2:

- Start marker
- Machining, main spindle
- Complete transfer (withdraw blank: yes; cutting-off cycle: yes)
- Cutting-off
- Machining, counter-spindle
- Front face
- End marker
- Repeat from start to end marker







Note

You can withdraw the blank several times successively without parting in order to continue the machining on the same side.

Parameter	Description	Unit
Function 	You can select one of the following functions: <ul style="list-style-type: none"> • Complete transfer • Gripping • Withdrawing • Machining side 	
Workpiece transfer	<ul style="list-style-type: none"> • Main spindle in counter-spindle • Counter-spindle in main spindle 	
Complete transfer function	Gripping	
Coordinate system 	<ul style="list-style-type: none"> • Machine coordinate system (MCS) The park position is specified in the machine coordinate system. Teaching in the park position and angular offset is only possible in the machine coordinate system. • Workpiece coordinate system (WCS) The park position is specified in the workpiece coordinate system. 	
XP	Park position of tool in X direction (abs)	mm
ZP	Park position of tool in Z direction (abs)	mm
Flush chuck 	Flush counter-spindle chuck <ul style="list-style-type: none"> • Yes • No 	
DIR 	Direction of rotation <ul style="list-style-type: none"> •  Spindle rotates clockwise •  Spindle rotates counter-clockwise •  Spindle does not rotate 	
Clamping	Clamping both spindles (only if spindles are not turning) <ul style="list-style-type: none"> •  Clamping open •  Clamping closed 	
S	Spindle speed – (only when the spindle rotates)	rev/min
α1	Angular offset	Degrees
Z1	Transfer position (abs.)	
ZR 	Position, feedrate reduction (abs or inc) Position from which a reduced feedrate is used.	
FR	Reduced feedrate	mm/rev
Fixed stop	Travel to fixed stop <ul style="list-style-type: none"> • Yes The counter-spindle stops at a defined distance away from transfer position Z1 and then traverses with a defined feedrate up to the fixed stop. • No The counter-spindle traverses to the transfer position Z1. 	
	Withdrawing	



Parameter	Description	Unit
Withdraw blank	Withdraw complete blank: <ul style="list-style-type: none"> • Yes • No 	
F	Feed - withdraw for blank "yes"	mm/min
Cutting-off cycle	Cutting-off cycle in the following block <ul style="list-style-type: none"> • Yes • No 	
	Rear - for main spindle in counter-spindle	
Work offset 	Work offset in which the coordinate system, which was shifted according to ZW and by ZV as well as mirrored in Z, must be saved: <ul style="list-style-type: none"> • Basic reference • G54 • G55 • G56 • G57 • ... 	
Write to the work offset 	<ul style="list-style-type: none"> • Yes The Z value of the work offset can be directly written to the input screen form. • No The actual Z value of the work offset is used. 	
ZV - only for work offset write "yes"	<ul style="list-style-type: none"> • Offset Z = 0 (abs) • Workpiece zero is offset in Z direction (inc, the sign is also evaluated) The workpiece is re-clamped when switching between the main spindle and counterspindle. The new work offset defines the position for machining at the machine. However, the simulation must know by which amount the work offset has shifted with respect to the workpiece, so that both sides of the machining can be displayed. 	mm
Z4W	Machining position for special axis (abs.); machine coordinate system	mm
	Front face - for counter-spindle in main spindle	
Work offset 	Work offset in which the coordinate system, which was shifted according to ZW and by ZV as well as mirrored in Z, must be saved: Basic reference <ul style="list-style-type: none"> • G54 • G55 • G56 • G57 • ... 	
Write to the work offset 	<ul style="list-style-type: none"> • Yes The Z value of the work offset can be directly written to the input screen form. • No The actual Z value of the work offset is used. 	

Parameter	Description	Unit
ZV - only for work offset write "yes"	<ul style="list-style-type: none"> • Offset Z = 0 (abs) • Workpiece zero is offset in Z direction (inc, the sign is also evaluated) The workpiece is re-clamped when switching between the main spindle and counterspindle. The new work offset defines the position for machining at the machine. However, the simulation must know by which amount the work offset has shifted with respect to the workpiece, so that both sides of the machining can be displayed. 	mm
Z4P	Machining position for special axis (abs.); machine coordinate system	mm



Parameter	Description	Unit
Function, gripping	Teaching in the park position and angular offset is possible	
Gripping a blank	<ul style="list-style-type: none"> • With main spindle The blank is gripped with the main spindle • With counter-spindle The blank is gripped with the counter-spindle 	
Work offset - only for "with main spindle"	Buffer work offset: <ul style="list-style-type: none"> • Basic reference • G54 • G55 • G56 • G57 • ... 	
Coordinate system 	<ul style="list-style-type: none"> • MCS The park position is specified in the machine coordinate system. Teaching in the park position and angular offset is only possible in the machine coordinate system. • WCS The park position is specified in the workpiece coordinate system. 	
XP	Park position of tool in X direction (abs)	mm
ZP	Park position of tool in Z direction (abs)	mm
Flush chuck 	Flush counter-spindle chuck <ul style="list-style-type: none"> • Yes • No 	
DIR 	Direction of rotation <ul style="list-style-type: none"> •  Spindle rotates clockwise •  Spindle rotates counter-clockwise •  Spindle does not rotate 	
S	Spindle speed – (only when the spindle rotates)	rev/min
α1	Angular offset	Degrees
Z1	Transfer position (abs.)	
ZR 	Position, feedrate reduction (abs or inc) Position from which a reduced feedrate is used.	

10.7 Additional cycles and functions in ShopTurn

Parameter	Description	Unit
FR	Reduced feedrate	mm/rev
Fixed stop	Travel to fixed stop <ul style="list-style-type: none"> • Yes The counter-spindle stops at a defined distance away from transfer position Z1 and then traverses with a defined feedrate up to the fixed stop. • No The counter-spindle traverses to the transfer position Z1. 	

Parameter	Description	Unit
Function, withdrawing		
Withdraw blank	<ul style="list-style-type: none"> • From main spindle The blank is withdrawn from the main spindle • From counter-spindle The blank is withdrawn from the counter-spindle 	
Also take zero point 	Also take zero point <ul style="list-style-type: none"> • Yes • No 	
Work offset  - only when for "with-draw NP" "yes"	Work offset in which the coordinate system offset by Z1 must be saved. <ul style="list-style-type: none"> • Basic reference • G54 • G55 • G56 • G57 • ... 	
Z1	Amount by which the workpiece is withdrawn from the main spindle (inc)	
F	Feedrate	mm/min

Parameter	Description	Unit
Machining side function		
Machining	Selection of the spindle for machining: <ul style="list-style-type: none"> • Main spindle Machining on the main spindle • Counter-spindle Machining on the counter-spindle 	

Parameter	Description	Unit
Work offset 	Work offset in which the coordinate system, which was shifted according to ZW and by ZV as well as mirrored in Z, must be saved: <ul style="list-style-type: none"> • Basic reference • G54 • G55 • G56 • G57 • ... 	
Write to the work offset 	<ul style="list-style-type: none"> • Yes The Z value of the work offset can be directly written to the input screen form. • No The actual Z value of the work offset is used. 	
ZV - only for work offset write "yes"	<ul style="list-style-type: none"> • Offset Z = 0 (abs) • Workpiece zero is offset in Z direction (inc, the sign is also evaluated) The parameter is used to ensure that the correct display is shown in the simulation. It has no influence on machining itself. The workpiece is re-clamped when switching between the main spindle and counterspindle. The new work offset defines the position for machining at the machine. However, the simulation must know by which amount the work offset has shifted with respect to the workpiece, so that both sides of the machining can be displayed. 	mm mm
Park counter-spindle - for machining with main spindle	<ul style="list-style-type: none"> • Yes The counter-spindle is traversed to the park position. • No The counter-spindle is not traversed. 	
Z4P - for machining with main spindle	Park position of the counter-spindle (abs); MCS	mm
Z4W - for machining with counter-spindle	Machining position of the counter-spindle (abs); MCS	mm

10.7.18 Machining with fixed counterspindle

If your lathe is equipped with a second spindle, which is setup as a counterspindle and cannot be traversed, then the workpieces must be manually reclamped



Machine manufacturer

Please refer to the machine manufacturer's specifications.

Machining with main spindle and counterspindle

For instance, a new blank can be clamped in the main spindle, and a blank that has already been machined at the front can be clamped in the counterspindle. With the ShopTurn program,

initially the workpiece is machined in the main spindle, and then the rear side of the workpiece, already machined at the front, is machined in the counter spindle.

Note

Various workpieces

You have the option of machining two different workpieces at the main spindle and counterspindle.



Machine manufacturer

Please refer to the machine manufacturer's specifications.

Parameter	Description	Unit
Function U	You can select one of the following functions: <ul style="list-style-type: none"> • Front face • Rear face 	

Parameter	Description	Unit
Function, front face		
Work offset U	Work offset for machining the next front face: <ul style="list-style-type: none"> • Basic reference • G54 • G55 • G56 • G57 • ... 	

Parameter	Description	Unit
Function, rear face		
Work offset U	Work offset in which the coordinate system, which was shifted according to ZW and by ZV as well as mirrored in Z, must be saved: <ul style="list-style-type: none"> • Basic reference • G54 • G55 • G56 • G57 • ... 	
Write to the work offset	<ul style="list-style-type: none"> • Yes The Z value of the work offset can be directly written to the input screen form. • No The actual Z value of the work offset is used. 	

Parameter	Description	Unit
ZV (abs) - only for work offset. write "yes"	Z value of the work offset.	mm
ZV (inc)	Workpiece zero is offset in Z direction (the sign is also evaluated) The parameter is used to ensure that the correct display is shown in the simulation. It has no influence on machining itself. The workpiece is re-clamped when switching between the main spindle and counterspindle. The new work offset defines the position for machining at the machine. However, the simulation must know by which amount the work offset has shifted with respect to the workpiece, so that both sides of the machining can be displayed.	mm

See also

Program header (Page 296)

Program header with multi-channel data (Page 667)

Multi-channel machining

11.1 Multi-channel view

The multi-channel view allows you to simultaneously view several channels in the following operating areas:

- "Machine" operating area
- "Program" operating area

11.1.1 Multi-channel view in the "Machine" operating area

With a multi-channel machine, you have the option of simultaneously monitoring and influencing the execution of several programs.



Machine manufacturer

Please observe the information provided by the machine manufacturer.

Displaying the channels in the "Machine" operating area

In the "Machine" operating area, you can display 2 - 4 channels simultaneously.

Using the appropriate settings, you can define the sequence in which channels are displayed. Here, you can also select if you wish to hide a channel.

Note

The "REF POINT" operating mode is shown only in the single-channel view.

Multi-channel view

2 - 4 channels are simultaneously displayed in channel columns on the user interface.

- Two windows are displayed one above the other for each channel.
- The actual value display is always in the upper window.
- The same window is displayed for both channels in the lower window.
- You can select the display in the lower window using the vertical softkey bar.
 - The following exceptions apply when making a selection using the vertical softkeys:
 - The "Actual values MCS" softkey switches over the coordinate systems of both channels.
 - The "Zoom actual value" and "All G functions" softkeys switch into the single-channel view.

Single-channel view

If you only wish to monitor one channel for your multi-channel machine, then you can set a permanent single-channel view.

Horizontal softkeys

- Block search
When selecting the block search, the multi-channel view is kept. The block display is displayed as search window.
- Program control
The "Program Control" window is displayed for the channels configured in the multi-channel view. The data entered here applies for these channels together.
- If you press an additional horizontal softkey in the "Machine" operating area (e.g. "Overstore", "Synchronized actions"), then you change into a temporary single-channel view. If you close the window again, then you return to the multi-channel view.

Switching between single- and multi-channel view



Press the <MACHINE> key in order to briefly switch between the single- and multi-channel view in the machine area.



Press the <NEXT WINDOW> key in order to switch between the upper and lower window within a channel column.

Editing a program in the block display



You can perform simple editing operations as usual with the <INSERT> key in the actual block display.

If there is not sufficient space, you switch over into the single-channel view.

Running-in a program

You select individual channels to run-in the program at the machine.

Requirement

- Several channels have been set-up.
- The setting "2 channels", "3 channels" or "4 channels" is selected.

Displaying/hiding a multi-channel view



1. Select the "Machine" operating area



2. Select the "JOG", "MDA" or "AUTO" mode.

...



3. Press the menu forward key and the "Settings" softkey.



4. Press the "Multi-channel view" softkey.

5. In the window "Settings for Multi-Channel View" in the selection box "View", select the required entry (e.g. "2 channels") and define the channels as well as the sequence in which they are to be displayed.

In the basic screen for the "AUTO", "MDA" and "JOG" operating modes, the upper window of the left-hand and right-hand channel columns are occupied by the actual value window.

6. Press the "T,F,S" softkey if you wish to view the "T,F,S" window. The "T,F,S" window is displayed in the lower window of the left-hand and right-hand channel column.



Note:

The "T,F,S" softkey is present only for smaller operator panels, i.e. up to OP012.

See also

Setting the multi-channel view (Page 655)

11.1.2 Multi-channel view for large operator panels

On the OP015 and OP019 operator panels as well as on the PC, you have the option of displaying up to four channels next to each one. This simplifies the creation and run-in for multi-channel programs.

Constraints

- OP015 with a resolution of 1024x768 pixels: up to three channels visible
- OP019 with a resolution of 1280x1024 pixels: up to four channels visible
- The operation of a OP019 requires a PCU50.5

3- or 4-channel view in the "Machine" operating area

Use the multi-channel view settings to select the channels and specify the view.

Channel view	Display in the "Machine" operating area
3-channel view	<p>The following windows are displayed one above the other for each channel:</p> <ul style="list-style-type: none"> • Actual Value window • T,F,S window • Block Display window <p>Selecting functions</p> <ul style="list-style-type: none"> • The T,F,S window is overlaid by pressing one of the vertical softkeys.
4-channel view	<p>The following windows are displayed one above the other for each channel:</p> <ul style="list-style-type: none"> • Actual Value window • G functions (the "G functions" softkey is omitted). "All G functions" is accessed with the Menu forward key. • T,S,F window • Block Display window <p>Selecting functions</p> <ul style="list-style-type: none"> • The window showing the G codes is overlaid if you press one of the vertical softkeys.

Toggling between the channels



Press the <CHANNEL> key to toggle between the channels.



Press the <NEXT WINDOW> key to toggle within a channel column between the three or four windows arranged one above the other.

Note

2-channel display

Unlike the smaller operator panels, the T,F,S window is visible for a 2-channel view in the "Machine" operating area.

Program operating area

You can display as many as ten programs next to each other in the editor.

Displaying a program

You can define the width of the program in the Editor window using the settings in the editor. This means that you can distribute programs evenly - or you can widen the column with the active program .

Channel status

When required, channel messages are displayed in the status display.

**Machine manufacturer**

Please refer to the machine manufacturer's specifications.

11.1.3 Setting the multi-channel view

Setting	Meaning
View	Here, you specify how many channels are displayed. <ul style="list-style-type: none"> • 1 channel • 2 channels • 3 channels • 4 channels
Channel selection and sequence (for "2 - 4 channels" view)	You specify which channels in which sequence are displayed in the multi-channel view.
Visible (for "2 - 4 channels" view)	Here, you specify which channels are displayed in the multi-channel view. You can quickly hide channels from the view.

Example

Your machine has 6 channels.

You configure channels 1 - 4 for the multi-channel view and define the display sequence (e.g. 1,3,4,2).

In the multi-channel view, for a channel switchover, you can only switch between the channels configured for the multi-channel view; all others are not taken into consideration. Using the <CHANNEL> key, advance the channel in the "Machine" operating area - you obtain the following views: Channels "1" and "3", channels "3" and "4", channels "4" and "2". Channels "5" and "6" are not displayed in the multi-channel view.

In the single-channel view, toggle between all of the channels (1..6) without taking into account the configured sequence for the multi-channel view.

Using the channel menu, you can always select all channels, also those not configured for multi-channel view. If you switch to another channel, which is not configured for the multi-channel view, then the system automatically switches into the single-channel view. There is no automatic switchback into the multi-channel view, even if a channel is again selected, which has been configured for multi-channel view.

Procedure



1. Select the "Machine" operating area.



2. Select the "JOG", "MDA" or "AUTO" mode.



3. Press the menu forward key and the "Settings" softkey.



4. Press the "Multi-channel view" softkey.
The "Settings for Multi-Channel View" window is opened.
5. Set the multi-channel or single-channel view and define which channels are to be seen in the "Machine" operating area - and in the editor - in which sequence.

11.2 Multi-channel support

11.2.1 Working with several channels

Multi-channel support

SINUMERIK Operate supports you when generating the program, the simulation and when running-in a program on multi-channel machines.



Software options

For the multi-channel functionality and support, i.e. for generating and editing synchronized programs in the multi-channel editor as well as the block search, you require the "programSYNC" option.



Software options

You require the "ShopMill/ShopTurn" option to generate and edit ShopTurn machining step programs.

Note

Execution and simulation

The execution and simulation for multi-channel programming does not function if the programs and the job list are on an external storage medium, e.g. on the local drive.

Multi-channel view

With the multi-channel view, you have the option of viewing several channels in parallel on the display. This means that for multi-channel machines, the execution of several programs - simultaneously started - can be monitored and controlled.

View of the channels

In the window "Settings for multi-channel view" or "Settings for multi-channel functionality", you set which channels are important for the program execution and which channels are displayed simultaneously. In so doing, you also define the channel sequence.

Note

Hidden channels

Hidden channels still belong to the group of channels that are handled together. They are only temporarily excluded from the multi-channel view.

In the multi-channel editor, you have the option of simultaneously opening several programs and editing them. In this case, the multi-channel editor supports you regarding program synchronization from a time perspective.

11.2.2 Creating a multi-channel program

All of the programs involved in a multi-channel machining operation are combined in one workpiece.

In a job list, enter the program names, define the program type - G code or ShopTurn program - and assign these to a channel.



Machine manufacturer

If you only program G code programs, then you can switch-out the multi-channel view. Please refer to the machine manufacturer's specifications.

Precondition

- "programSYNC" option

Procedure



1. Select the "Program Manager" operating area.



2. Press the "NC" softkey and select the "Workpieces" folder.



3. Press the "New" and "programSYNC multi-channel" softkeys. The "New job list" window opens.



4. Enter the required name and press the "OK" softkey.



The "Job list *.JOB" window opens.

For each channel that has been set up, the window has one line for entering or selecting the assigned program.



5. Position the cursor on the required channel line, enter the required program name and select the program type (G code or ShopTurn).

6. Press the "OK" softkey.

The "Multi-channel data" parameter screen opens in the editor.

11.2.3 Entering multi-channel data

In the parameter screen "Multi-channel data", enter the following data, which applies for all channels for G code and ShopTurn programs:

- Measurement unit
- Work offset (e.g. G54)
- Z value of the work offset (optional)







- Blank
- Spindle chuck data (optional)
- Speed limitation
- If applicable data for the counter-spindle
- Counter-spindle with/without mirroring (for G code)





Machine manufacturer

If you are working with pure G code programming, it is possible that the parameter screen "Multi-channel data" does not open.

Please observe the information provided by the machine manufacturer.

Parameter	Description	Unit
Measurement unit 	Selecting the measurement unit	mm inch
Main spindle		
Work offset	Selecting the work offset	
Write to the work offset 	<ul style="list-style-type: none"> • Yes Parameter ZV is displayed • No Parameter ZV is not displayed 	
ZV	Z value of the work offset For G54, the Z value is entered into the work offset. Note: Please observe the information provided by the machine manufacturer.	
Blank 	<ul style="list-style-type: none"> • Tube • Cylinder • Polygon • Centered cuboid 	
XA	Outside diameter \varnothing – for tube and cylinder	mm
XI	Inside diameter (abs) or wall thickness (inc) – only for tube	mm
ZA	Initial dimension	mm
ZI 	Final dimension (abs) or final dimension in relation to ZA (inc)	
ZB 	Machining dimension (abs) or machining dimension in relation to ZA (inc)	mm
N	Number of edges – only for polygon	
SW or L 	Width across flats or edge length – only for polygon	mm
W	Width of the blank - only for centered cuboid	mm
L	Length of the blank - only for centered cuboid	mm
S	Speed limitation of the main spindle	rev/min

Parameter	Description	Unit
Spindle chuck data	<ul style="list-style-type: none"> • Yes You enter spindle chuck data in the program. • No Spindle chuck data is transferred from the setting data. Note: Please observe the information provided by the machine manufacturer.	
Spindle chuck data	<ul style="list-style-type: none"> • Only chuck You enter spindle chuck data in the program. • Complete You enter tailstock data in the program. Note: Please observe the information provided by the machine manufacturer.	
ZC	<ul style="list-style-type: none"> • The main spindle chuck dimensions - (only for spindle chuck data "yes") 	mm
ZS	<ul style="list-style-type: none"> • Stop dimension of the main spindle - (only for spindle chuck data "yes") 	mm
ZE	<ul style="list-style-type: none"> • Jaw dimension of the main spindle for jaw type 2 - (only for spindle chuck data "yes") 	mm
Counter-spindle		
Spindle chuck data	<ul style="list-style-type: none"> • Yes You enter spindle chuck data in the program. • No Spindle chuck data is transferred from the setting data. Note: Please observe the information provided by the machine manufacturer.	
Spindle chuck data	<ul style="list-style-type: none"> • Only chuck You enter spindle chuck data in the program. • Complete You enter tailstock data in the program. Note: <ul style="list-style-type: none"> • Please observe the information provided by machine manufacturer. 	
Jaw type	Selecting the jaw type of the counter-spindle. Dimensions of the front edge or stop edge - (only if spindle chuck data "yes") <ul style="list-style-type: none"> • Jaw type 1 • Jaw type 2 	
ZC	The counter-spindle chuck dimensions - (only for spindle chuck data "yes")	mm
ZS	Stop dimension of the counter-spindle - (only for spindle chuck data "yes")	mm
ZE	Jaw dimension of the counter-spindle for jaw type 2 - (only for spindle chuck data "yes")	mm
XR	Tailstock diameter - (only for spindle chuck data "complete" and tailstock that has been set up)	mm
ZR	Tailstock length - (only for spindle chuck data "complete" and tailstock that has been set up)	mm
Mirroring Z	<ul style="list-style-type: none"> • Yes Mirroring is used when machining on the Z axis • No Mirroring is not used when machining on the Z axis 	

Parameter	Description	Unit
Work offset	Selecting the work offset	
Write to the work offset	<ul style="list-style-type: none"> • Yes Parameter ZV is displayed • No Parameter ZV is not displayed 	
ZV	Z value of the work offset The value exceeds the Z value in the selected work offset.	
Blank 	<ul style="list-style-type: none"> • Tube • Cylinder • Polygon • Centered cuboid 	
ZA	Initial dimension	mm
ZI	Final dimension (abs) or final dimension in relation to ZA (inc)	mm
ZB	Machining dimension (abs) or machining dimension in relation to ZA (inc)	mm
XA	Outside diameter – (only for tube and cylinder)	mm
XI	Inside diameter (abs) or wall thickness (inc) – (only for tube)	mm
N	Number of edges – (only for polygon)	
SW or L 	Width across flats or edge length – (only for polygon)	mm
W	Width of the blank - (only for centered cuboid)	mm
L	Length of the blank - (only for centered cuboid)	mm
S	Speed limitation of the counter-spindle	rev/min

Procedure

1. You have created programs for the multi-channel machining in the job list and the parameter screen "Multi-channel data" is open in the editor.
2. Enter the data for the cross-channel data.
3. Press the "Accept" softkey.



The multi-channel editor is opened and displays the programs that have been created.

The cursor is positioned on an empty line before the cycle for the job list (CYCLE208). You can also enter a comment.

Note:

Note that CYCLE208 must appear within the first 20 lines in job list programs.

After the cycle call, enter the required initializations for the G code program and add the program code.

11.2.4 Multi-channel functionality for large operator panels

For the large OP 015, OP 019 operator panels as well as at the PC, there is more space in the "Machine", "Program" and "Parameter" operating areas – as well as in all lists – to display NC blocks, tools etc.

Further, you also have the option of simultaneously displaying more than 2 channels.

This makes it easier for you to identify the machine situation for machines with 3 and more channels. Further, it makes it simpler for you to generate and run-in three or four-channel programs.



Software options

If you require the option "programSYNC" for the views described here.

Supplementary conditions

- OP 015, OP 019 or PC with a display of at least 1280x1024 pixels
- For operating an OP 019, at least one NCU720.2 or 730.2 with 1 GB of RAM or a PCU50 is required

3 / 4-channel view in the "Machine" operating area

If you have selected 3 channels via settings, then 3 or 4 channel columns are displayed next to one another.

Channel view	Display in the "Machine" operating area
3-channel view	The following windows are displayed one above the other for each channel: <ul style="list-style-type: none"> • Actual value window • T,F,S window • Block display window
4-channel view	The following windows are displayed one above the other for each channel: <ul style="list-style-type: none"> • Actual value window • T,S,F window • G functions (the "G functions" softkey is omitted) • Block display window

Displaying functions

Channel view	Display in the "Machine" operating area
	Selection using vertical softkeys:
3-channel view	<ul style="list-style-type: none"> • The T,F,S window is overlaid by pressing one of the vertical softkeys.
4-channel view	<ul style="list-style-type: none"> • The window showing the G codes is overlaid if you press one of the vertical softkeys.
	Selection using horizontal softkeys:

Channel view	Display in the "Machine" operating area
3-channel view / 4 channel view	<ul style="list-style-type: none"> The block display is overlaid if you press the "Overstore" horizontal softkey
	<ul style="list-style-type: none"> The block display is overlaid by pressing the softkey "block search".
	<ul style="list-style-type: none"> The window is shown as a pop-up if you press the "Prog. control" softkey.
	<ul style="list-style-type: none"> If you press one of the horizontal softkeys in the "JOG" operating mode (e.g. "T,S,M", "Meas. tool", "Positions" etc.), then you change into the single-channel view.

Toggling between the channels



Press the <CHANNEL> key to toggle between the channels.



Press the <NEXT WINDOW> key to toggle within a channel column between the three or four windows arranged one above the other.

Note

2-channel display

Contrary to the smaller operator panels, in the "Machine" operating area, for a 2-channel view, the TFS window is visible.

Program operating area

In the editor, just as many programs are displayed next to one another as in the "Machine" operating area.

Displaying a program

You can define the width of the program in the editor window using the settings in the editor. This means that you can distribute programs evenly - or you can display the column with the active program wider.

Simulation

In the simulation window, actual values are displayed for a maximum of 4 channels simultaneously as well as the actual block.

You can toggle between displaying the traversing paths and the channel zero point using the "Channel+" and "Channel-" softkeys.

Axes, which are located in several channels, are displayed grayed-out if the setpoint comes from a different channel.

Channel status

When required, channel messages are displayed in the status display.



Machine manufacturer

Please refer to the machine manufacturer's specifications.

11.2.5 Editing the multi-channel program

11.2.5.1 Changing the job list

You now have the option to change the composition of the programs and/or the assignment of the channel and program in a job list.

Precondition

- "programSYNC" option

Procedure



1. Select the "Program Manager" operating area.



2. Select where the multi-channel program should be archived



3. Position the cursor in the "Workpieces" folder on a job list and press the "Open" softkey.

The window "Job list * JOB" is opened and the program assignment to the channels is displayed.



4. Select the channel to which you wish to assign a new program and press the softkey "Select program".

The "Program" window is opened and displays all of the programs created in the workpiece.

- OR -



Press the "Open job list" softkey.

11.2.5.2 Editing a G code multi-channel program

Editing a G code multi-channel program

Precondition

- The "programSYNC" option is set.
- In order to display the machining at the counterspindle at the correct position in the simulation, the linear axis of the counterspindle must be positioned before CYCLE208 (multi-channel data).



Machine manufacturer

Please refer to the machine manufacturer's specifications.

Procedure



1. Position the cursor in the "Workpieces" folder on a job list and press the "Open" softkey.

Note:

If the cursor is located on a workpiece, then a search is made for a job list with the same name.

The "Job list ..." window opens and the program assignment to the channels is displayed.



2. Press the "OK" softkey.

The programs are displayed next to one another in the editor.



3. Position the cursor on the first block of the program (multi-channel data) and press the <Cursor right> key.

The parameter screen "Multi-channel data" is opened.

4. Enter the required values if you wish to change cross-channel data.

Adding multi-channel data in a G code program

You have the possibility of adding the multi-channel cycle (CYCLE208) subsequently.

Procedure



1. The double editor is opened and the cursor is positioned in the G code program.

2. Press the "Misc." and "Multi-channel data" softkeys.

The "Call multi-channel data" input window opens.

A field for specifying the job list appears.





This field is read-only.





3. Press the "Accept job list" softkey.
The name of the job list is entered in the field.
4. Press the "Accept" softkey.
CYCLE208 is taken over into the program. The name of the job list is indicated in brackets.

Modify blank

Parameter	Description	Unit
Data for	Here, you specify the spindle selected for the blank. <ul style="list-style-type: none"> • Main spindle • Counterspindle 	
Blank 	The following blanks can be selected: <ul style="list-style-type: none"> • Tube • Cylinder • Polygon • Centered cuboid • Delete 	
W	Width of the blank - (only for centered cuboid)	mm
L	Length of the blank - (only for centered cuboid)	mm
N	Number of edges – (only for polygon)	
SW or L 	Width across flats or edge length – (only for polygon)	
ZA	Initial dimension	
ZI 	Final dimension (abs) or final dimension in relation to ZA (inc)	
ZB 	Machining dimension (abs) or machining dimension in relation to ZA (inc)	
XA	Outside diameter – (only for tube and cylinder)	mm
XI 	Inside diameter (abs) or wall thickness (inc) – for tube only	mm

Procedure



1. The double editor is opened and the cursor is positioned in the G code program.
2. Press the "Misc." and "Blank" softkeys.
The "Blank Input" window opens.



3. Select the desired blank and enter the corresponding values.
4. Press the "Accept" softkey.

11.2.5.3 Editing a ShopTurn multi-channel program

Precondition

The "programSYNC" option is set.

Procedure



1. Position the cursor in the "Workpieces" folder on a job list and press the "Open" softkey.

Note:

If the cursor is located on a workpiece, then a search is made for a job list with the same name.

The "Job list ..." window opens and the program assignment to the channels is displayed.



2. Press the "OK" softkey.
The programs are displayed next to one another in the editor.
3. Open the program header if you wish to define cross-program entries.











Program header with multi-channel data







In the program header, set the parameters, which are effective for the complete program.

You have the following options to save cross-program data:

- You can enter values in a common data set for the main and counterspindle
- You can enter values for the main and/or counterspindle

Parameter	Description	Unit
Multi-channel data	Yes Name of the job list in which the channel data are saved.	
Data for 	<ul style="list-style-type: none"> • Main+counterspindle All values for the main and counterspindle are saved in one data set • Main spindle Data set for the main spindle • Counterspindle Data set for the counterspindle <p>Note: If the machine does not have a counterspindle, then the entry field "Data for" is not applicable.</p>	

Parameter	Description	Unit
Retraction 	The retraction area indicates the area outside of which collision-free traversing of the axes must be possible. <ul style="list-style-type: none">• simple• Extended• all	
XRA 	Retraction plane X external \emptyset (abs) or retraction plane X referred to XA (inc)	
XRI 	- not for "basic" retraction retraction plane X internal \emptyset (abs) or retraction plane X referred to XI (inc) - not for "pipe" blank	mm
ZRA 	Retraction plane Z front (abs) or retraction plane Z referred to ZA (inc)	mm
ZRI 	Retraction plane Z rear – only for retraction "all"	mm
Tailstock 	<ul style="list-style-type: none">• Yes• No	
XRR	Retraction plane tailstock – only "Yes" for tailstock For "Main+counterspindle", the tailstock only refers to the main spindle (tailstock on the counterspindle side)	mm
Tool change point 	Tool change point, which must be approached by the revolver with its zero point. <ul style="list-style-type: none">• WCS (Workpiece Coordinate System)• MCS (Machine Coordinate System) Notes <ul style="list-style-type: none">• The tool change point must be far enough outside the retraction area that it is not possible for any tool to protrude into the retraction area while the revolver is moving.• Ensure that the tool change point is relative to the zero point of the revolver and not the tool tip.	
XT	Tool change point X \emptyset	mm
ZT	Tool change point Z	mm
Data for 	If several spindles have been set up, the program can operate at both spindles. Select the 2nd spindle <ul style="list-style-type: none">• Main spindle• Counterspindle• Empty The program only operates at one spindle	
Retraction 	The retraction area indicates the area outside of which collision-free traversing of the axes must be possible. <ul style="list-style-type: none">• simple• extended – (not for a pipe blank)• all	
XRA 	Retraction plane X external \emptyset (abs) or retraction plane X referred to XA (inc)	











Parameter	Description	Unit
XRI 	- only for a pipe blank retraction plane X internal \varnothing (abs) or retraction plane X referred to XI (inc)	mm
ZRA 	Retraction plane Z front (abs) or retraction plane Z referred to ZA (inc)	rev/min
ZRI 	Retraction plane Z rear – only for retraction "all"	mm
Tailstock 	<ul style="list-style-type: none"> • Yes • No 	
XRR	Retraction plane tailstock – only "Yes" for tailstock	mm
Tool change point 	<p>Tool change point, which must be approached by the revolver with its zero point.</p> <ul style="list-style-type: none"> • WCS (Workpiece Coordinate System) • MCS (Machine Coordinate System) <p>Notes</p> <ul style="list-style-type: none"> • The tool change point must be far enough outside the retraction area that it is not possible for any tool to protrude into the retraction area while the revolver is moving. • Ensure that the tool change point is relative to the zero point of the revolver and not the tool tip. 	
XT	Tool change point X \varnothing	mm
ZT	Tool change point Z	mm
SC	<p>The safety clearance defines how close the tool can approach the workpiece in rapid traverse.</p> <p>Note</p> <p>Enter the safety clearance without sign into the incremental dimension.</p>	mm
Mach. direction of rotation 	<p>Milling direction</p> <ul style="list-style-type: none"> • Conventional • Climbing 	

Program header without multi-channel data

If a program is to be executed through one channel, then deselect multi-channel data. You then have the option of entering cross-program values into the program header as usual.

Parameter	Description	Unit
Multi-channel data	<ul style="list-style-type: none"> • No <p>This is only possible if you are not using a job list.</p>	
Measurement unit 	<p>The setting of the measurement unit in the program header only refers to the position data in the actual program.</p> <p>All other data, such as feedrate or tool offsets, are entered in the unit of measure that you have set for the entire machine.</p>	mm inch





Parameter	Description	Unit			
Data for U	<ul style="list-style-type: none"> Main+counterspindle All values for the main and counterspindle are saved in one data set Main spindle Data set for the main spindle Counterspindle Data set for the counterspindle <p>If the machine does not have a counterspindle, then the entry field "Data for" is not applicable.</p>				
Work offset U	<p>The work offset in which the zero point of the workpiece is saved.</p> <p>You can also delete the default value of the parameter if you do not want to specify a work offset.</p>				
write to U	<ul style="list-style-type: none"> Yes Parameter ZV is displayed No Parameter ZV is not displayed 				
ZV	<p>Z value of the work offset</p> <p>For G54, the Z value is entered into the work offset.</p> <p>Note: Please observe the machine manufacturer's data</p>				
Blank U	<p>Define the form and dimensions of the workpiece:</p>				
	<ul style="list-style-type: none"> Cylinder 				
	<table border="1"> <tr> <td>XA</td> <td>Outer diameter \varnothing</td> <td>mm</td> </tr> </table>	XA	Outer diameter \varnothing	mm	
XA	Outer diameter \varnothing	mm			
	<ul style="list-style-type: none"> Polygon 				
	<table border="1"> <tr> <td>N</td> <td>Number of edges</td> <td></td> </tr> </table>	N	Number of edges		
N	Number of edges				
	<table border="1"> <tr> <td>SW / L U</td> <td>Width across flats/edge length</td> <td></td> </tr> </table>	SW / L U	Width across flats/edge length		
SW / L U	Width across flats/edge length				
	<ul style="list-style-type: none"> Centered cuboid 				
	<table border="1"> <tr> <td>W</td> <td>Width of blank</td> <td>mm</td> </tr> </table>	W	Width of blank	mm	
W	Width of blank	mm			
	<table border="1"> <tr> <td>L</td> <td>Length of blank</td> <td>mm</td> </tr> </table>	L	Length of blank	mm	
L	Length of blank	mm			
	<ul style="list-style-type: none"> Tube 				
	<table border="1"> <tr> <td>XA</td> <td>Outer diameter \varnothing</td> <td>mm</td> </tr> </table>	XA	Outer diameter \varnothing	mm	
XA	Outer diameter \varnothing	mm			
	<table border="1"> <tr> <td>U</td> <td>Inner diameter \varnothing (abs) or wall thickness (inc)</td> <td>mm</td> </tr> </table>	U	Inner diameter \varnothing (abs) or wall thickness (inc)	mm	
U	Inner diameter \varnothing (abs) or wall thickness (inc)	mm			
	<table border="1"> <tr> <td>ZA</td> <td>Initial dimension</td> <td>mm</td> </tr> </table>	ZA	Initial dimension	mm	
ZA	Initial dimension	mm			
	<table border="1"> <tr> <td>ZI U</td> <td>Final dimension (abs) or final dimension in relation to ZA (inc)</td> <td>mm</td> </tr> </table>	ZI U	Final dimension (abs) or final dimension in relation to ZA (inc)	mm	
ZI U	Final dimension (abs) or final dimension in relation to ZA (inc)	mm			
	<table border="1"> <tr> <td>ZB U</td> <td>Machining dimension (abs) or machining dimension in relation to ZA (inc)</td> <td></td> </tr> </table>	ZB U	Machining dimension (abs) or machining dimension in relation to ZA (inc)		
ZB U	Machining dimension (abs) or machining dimension in relation to ZA (inc)				
Retraction U	<p>The retraction area indicates the area outside of which collision-free traversing of the axes must be possible.</p>				
	<ul style="list-style-type: none"> simple 				
	<table border="1"> <tr> <td>XRA U</td> <td>Retraction plane X external \varnothing (abs) or retraction plane X referred to XA (inc)</td> <td>mm</td> </tr> </table>	XRA U	Retraction plane X external \varnothing (abs) or retraction plane X referred to XA (inc)	mm	
XRA U	Retraction plane X external \varnothing (abs) or retraction plane X referred to XA (inc)	mm			
	<table border="1"> <tr> <td>XRI U</td> <td>- only for "pipe" blank Retraction plane X internal \varnothing (abs) or retraction plane X referred to XI (inc)</td> <td>mm</td> </tr> </table>	XRI U	- only for "pipe" blank Retraction plane X internal \varnothing (abs) or retraction plane X referred to XI (inc)	mm	
XRI U	- only for "pipe" blank Retraction plane X internal \varnothing (abs) or retraction plane X referred to XI (inc)	mm			

Parameter	Description	Unit
	ZRA  Retraction plane Z front (abs) or retraction plane Z referred to ZA (inc)	mm
	<ul style="list-style-type: none"> extended - not for a "pipe" blank 	mm
	XRA  Retraction plane X external \varnothing (abs) or retraction plane X referred to XA (inc)	mm
	XRI  Retraction plane X internal \varnothing (abs) or retraction plane X referred to XI (inc)	mm
	ZRA  Retraction plane Z front (abs) or retraction plane Z referred to ZA (inc)	mm
	<ul style="list-style-type: none"> all 	mm
	XRA  Retraction plane X external \varnothing (abs) or retraction plane X referred to XA (inc)	
	XRI  Retraction plane X internal \varnothing (abs) or retraction plane X referred to XI (inc)	mm
	ZRA  Retraction plane Z front (abs) or retraction plane Z referred to ZA (inc)	mm
	ZRI  Retraction plant Z rear	mm
Tailstock 	<ul style="list-style-type: none"> Yes No 	
XRR	Retraction plane tailstock – only "Yes" for tailstock	mm
Tool change point 	<p>Tool change point, which must be approached by the revolver with its zero point.</p> <ul style="list-style-type: none"> WCS (Workpiece Coordinate System) MCS (Machine Coordinate System) <p>Notes</p> <ul style="list-style-type: none"> The tool change point must be far enough outside the retraction area that it is not possible for any tool to protrude into the retraction area while the revolver is moving. Ensure that the tool change point is relative to the zero point of the revolver and not the tool tip. 	
XT	Tool change point X \varnothing	mm
ZT	Tool change point Z	mm
S	Spindle speed	rev/min
Spindle chuck data	<ul style="list-style-type: none"> Yes You enter spindle chuck data in the program. No Spindle chuck data are transferred from the setting data. <p>Note: Please observe the machine manufacturer's instructions.</p>	
Spindle chuck data	<ul style="list-style-type: none"> Only chuck You enter spindle chuck data in the program. Complete You enter tailstock data in the program. <p>Note: Please observe the machine manufacturer's instructions.</p>	

Parameter	Description	Unit
Data for U	If several spindles have been set up, the program can operate at both spindles. Select the 2nd spindle <ul style="list-style-type: none"> • Main spindle • Counterspindle • Empty The program only operates at one spindle	
Retraction U	The retraction area indicates the area outside of which collision-free traversing of the axes must be possible. <ul style="list-style-type: none"> • simple • extended – not for a "pipe" blank • all 	
XRA U	Retraction plane X external \emptyset (abs) or retraction plane X referred to XA (inc)	mm
XRI U	- for "basic" retraction, only for a "pipe" blank retraction plane X internal \emptyset (abs) or retraction plane X referred to XI (inc)	mm
ZRA U	Retraction plane Z front (abs) or retraction plane Z referred to ZA (inc)	mm
ZRI U	Retraction plane Z rear – only for retraction "all"	mm
Tailstock U	<ul style="list-style-type: none"> • Yes • No 	
XRR	Retraction plane tailstock – only "Yes" for tailstock	mm
Tool change point U	Tool change point, which must be approached by the revolver with its zero point. <ul style="list-style-type: none"> • WCS (Workpiece Coordinate System) • MCS (Machine Coordinate System) Notes <ul style="list-style-type: none"> • The tool change point must be far enough outside the retraction area that it is not possible for any tool to protrude into the retraction area while the revolver is moving. • Ensure that the tool change point is relative to the zero point of the revolver and not the tool tip. 	
XT	Tool change point X \emptyset	mm
ZT	Tool change point Z	mm
S	Spindle speed	rev/min
SC	The safety clearance defines how close the tool can approach the workpiece in rapid traverse. Note Enter the safety clearance without sign into the incremental dimension.	mm
Mach. direction of rotation U	Milling direction <ul style="list-style-type: none"> • Conventional • Climbing 	

Changing program settings

Under settings, the settings for the main and/or counterspindle can be changed while the program is being executed.

Parameter	Description	Unit
Data for	You define the spindle selection for processing the data here - (this is only available if the machine has a counterspindle) <ul style="list-style-type: none"> • Main spindle Data set for the main spindle • Counterspindle Data set for the counterspindle • Main+counterspindle All values for the main and counterspindle are saved in one data set 	
Retraction 	Lift mode <ul style="list-style-type: none"> • simple • Extended • all • Empty 	
XRA 	Retraction plane X external \emptyset (abs) or retraction plane X referred to XA (inc)	mm
XRI 	Retraction plane X internal \emptyset (abs) or retraction plane X referred to XI (inc) - (only for retraction "extended" and "all")	mm
ZRA 	Retraction plane Z front (abs) or retraction plane Z referred to ZA (inc)	mm
ZRI	Retraction plane Z rear – (only for retraction "all")	mm
Tailstock	Yes <ul style="list-style-type: none"> • Tailstock is displayed for simulation / simultaneous recording • When approaching/retracting, the retraction logic is taken into account No	
XRR	Retraction plane – (only "Yes" for tailstock)	mm
Tool change point	Tool change point <ul style="list-style-type: none"> • WCS (Workpiece Coordinate System) • MCS (Machine Coordinate System) • Empty 	
XT	Tool change point X	mm
ZT	Tool change point Z	mm
SC	Safety clearance (inc) Acts in relation to the reference point. The direction in which the safety clearance is active is automatically determined by the cycle.	mm
S1	Maximum speed, main spindle	rev/min
Machining direction	Milling direction: <ul style="list-style-type: none"> • Climbing • Conventional • Empty 	

Procedure



1. The ShopTurn program has been created.
2. Position the cursor at the location in the program where settings must be changed.
3. Press the "Various" and "Settings" softkeys.
The "Settings" input window opens.

11.2.5.4 Creating a program block

In order to structure programs in order to achieve a higher degree of transparency when preparing for the synchronized view, you have the possibility of combining several blocks (G code and/or ShopTurn machining steps) to form program blocks.

Structuring programs

- Before generating the actual program, generate a program frame using empty blocks.
- By forming blocks, structure existing G code or ShopTurn programs.

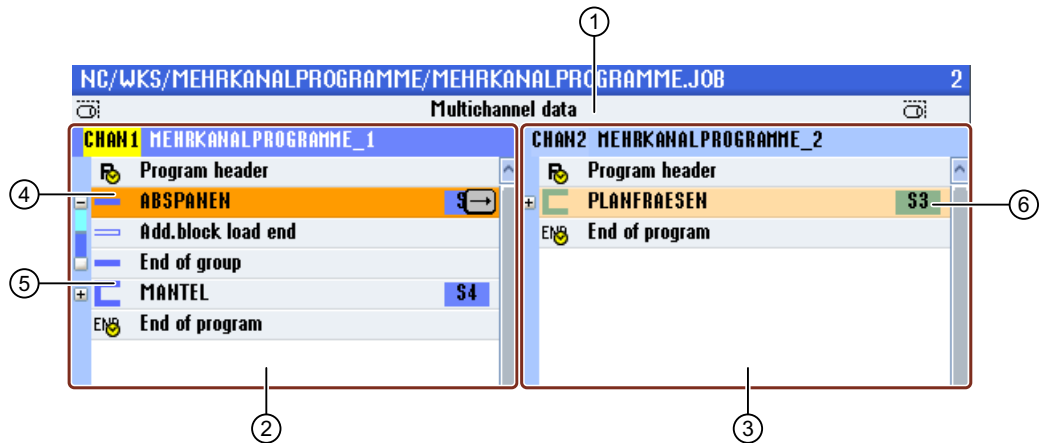

- ① Cross-channel data from the "Multi-channel data" window.
- ② "MULTI-CHANNEL PROGRAMS_1" program opened in channel 1.
- ③ "MULTI-CHANNEL PROGRAMS_2" program opened in channel 2.
- ④ Actual program with block name "Stock removal".
The program block has been opened and an Addit. run-in code has been activated.
The program block is assigned to the main spindle.
- ⑤ Program block with block name "Peripheral surface".
The program block is closed. In order to identify whether an Addit. run-in code is activated or automatic retraction is activated, open the block using the <Cursor right> key.
- ⑥ Program block with block name "Face milling".
The program block is assigned to the counter-spindle. The spindle assignment is color coded in order to make a distinction.

Figure 11-1 Structured programs in the multi-channel editor

Settings for a program block

Display	Meaning
Text	Block designation
Spindle	<ul style="list-style-type: none"> • S1 • S2 Spindle assignment. Defines at which spindle a program block is to be executed.
Addit. run-in code	<ul style="list-style-type: none"> • Yes For the case that the group is not executed, as the specified spindle should not be considered when running in, then it is possible to temporarily activate what is known as "Addit. run-in code". <ul style="list-style-type: none"> • No
Automat. retraction	<ul style="list-style-type: none"> • Yes Block start and block end are moved to the tool change point, i.e. the tool is retracted. <ul style="list-style-type: none"> • No

Note

Retraction via block function

When changing the machining spindle using program blocks, it must be ensured that no collisions occur at/on the machine when positioning.

Procedure



1. Select the "Program manager" operating area.



2. Select the storage location and create a program or open a program. The program editor opens.
3. Select the required program blocks, which you wish to combine to form a block.



4. Press the "Build group" softkey. The "Build group" window is opened.



5. Enter a designation for the block, assign the spindle, if required, select the Additional run-in code and the automatic retraction and then press the "OK" softkey.

Opening and closing blocks



...



...



1. Position the cursor on the desired program block.
2. Press the <+> key or the <Cursor right> key.

The block is opened.

3. Press the <-> key or the <Cursor left> key.

The block is closed again.

4. Press the "Open all blocks" softkey if you wish to display all the blocks.

5. Press the "Close all blocks" softkey if you wish to close all the blocks again.

Shifting blocks

You have the option of using "Select", "Copy", "Cut-out" and "Paste" softkeys to move individual or several blocks within the program.

11.2.6 Setting the multi-channel function

Setting	Meaning
View	Here, you specify how many channels are displayed. <ul style="list-style-type: none"> • 1 channel • 2 channels • 3 channels • 4 channels
Channel selection and sequence (for "2 - 4 channels" view)	Here, you create the channel group, i.e. you specify which channels and in which sequence are displayed in the multi-channel view.
Visible (for "2 - 4 channels" view)	Here, you specify which channels are displayed in the two-channel view.

Precondition



Software options

You require the "programSYNC" option to generate and edit synchronized programs in the multi-channel editor as well as for the multi-channel functions in the "Machine" operating area.

Example

Your machine has 6 channels.

You configure channels 1 - 4 for the multi-channel view and define the display sequence (e.g. 1,3,4,2).

Using the <CHANNEL> key, advance the channel in the "Machine" operating area - you obtain the following views: Channels "1" and "3", channels "3" and "4", channels "4" and "2". Channels "5" and "6" are not displayed in the multi-channel view.

In the single-channel view, toggle between all of the channels (1..6) without taking into account the configured sequence for the multi-channel view.

Procedure



1. Select the "Machine" operating area.



2. Select the operating mode "JOG", "MDA" or "AUTO".



3. Press the menu forward key and the "Settings" softkey.



4. Press the "Multi-channel function" softkey.
The "Settings for the multi-channel functionality" window is opened.

11.2.7 Synchronizing programs

Using the synchronized view, you have the possibility of obtaining an overview of the time sequence of a program. In this case, program instructions are evaluated to coordinate channels and are arranged in parallel in the editor view.

As a result of the synchronized view of the programs, you can easily identify at which locations the programs are synchronized in the various channels.

Synchronizing commands



Commands	Meaning
START	Starts another program
WAITM	Sets a mark and waits for the specified channels (with exact stop)
WAITMC	Sets a mark and waits for the specified channels (without exact stop)
WAITE	Waits for the end of program of the specified channels
SETM	Sets a mark
CLEARM	Clears a mark
GET	Fetches an axis
RELEASE	Releases an axis

Note

Error identification when synchronizing the programs

The error can only be identified if the appropriate program is displayed. If a WAIT mark involves a channel to which a program is not assigned in the job list, then this is marked as having an error.

If you have enabled the synchronized view, then the following symbols are displayed at the top right in the program title bar:

Symbol	Meaning
	Synchronized view: Error Errors were identified after enabling "synchronized view" or new "synchronization" (e.g. WAIT marks not found in other programs).
	Synchronized view: checked No error was detected after enabling "synchronized view" or new "synchronization".

Wait marks can also be used within blocks.

- Closed block
 - If there is a WAIT mark within a closed block, the clock of this WAIT mark is displayed in front of the block name.
In the synchronized view, the closed block is synchronized.
 - If there are several WAIT marks within a closed block, then a clock is displayed in front of the block name. It is yellow, if all clocks of the WAIT marks in the block are yellow, otherwise it is red.
In the synchronized view, the closed block is synchronized to the last WAIT mark in the block.
- Opened block
 - If there is a WAIT mark, the clock is displayed in front of the WAIT mark.
In front of the WAIT mark, the clock is displayed in either yellow or red. The program is synchronized at the WAIT mark.
 - If there are several WAIT marks, the clocks are displayed in either yellow or red at the WAIT marks. The program is synchronized at the WAIT marks.

Determination of processing times

After a simulation or during processing in automatic mode, the required processing time for the program blocks is displayed in the editor. For multi-channel programs, the delay time is displayed at the wait points.

Spindle transfer between the channels

If you use the spindles alternating in several channels (e.g. main and counterspindle), then it may be necessary to exit the active plane "Face C" (TRANSMIT) or "Peripheral C" (TRACYL):



1. Press the menu forward key and the "Straight/Circle" softkey.



2. Press the "Tool" softkey.
3. In the "Plane selection" field, select the "Turning" setting (TRAF00F).









Procedure



1. Select the required job list.



2. Press the "Open" softkey.
The job list is opened in the editor.

- | | | |
|---|----|--|
|  | 3. | Press the ">>" and "View" softkeys. |
|  | | |
|  | 4. | Press the softkey "Synchron. view". |
|  | 5. | Press the "Synchronizing" softkey if you wish to update the view after changes. |
|  | 6. | Press the "Open all blocks" softkey if you wish to view all of the program blocks in the synchronized display. |
|  | 7. | Press the "Close all blocks" softkey, if you wish to close the blocks to achieve a higher degree of transparency. |
|  | 8. | Select the required program. |
|  | | |
|  | 9. | Press the "Full screen" softkey.
The two-channel display is changed into a single-channel display and the selected program is displayed using the complete editor window. |

See also

Optimizing the machining time (Page 681)

11.2.8 Insert WAIT marks

To synchronize programs via several channels, you have the option of inserting WAIT marks. In the wait mark you define the type, and depending on the synchronizing command, the number and the channels to be synchronized.

WAIT marks

In the "WAIT mark" window, the following synchronizing commands are available:

Type	Meaning
WAITM	Sets a mark and waits for the specified channels (with exact stop)
WAITMC	Sets a mark and waits for the specified channels (without exact stop)
WAITE	Waits for the end of program of the specified channels (current channel not specified) Note: Numbers or variables cannot be entered.

Type	Meaning
SETM	Sets a mark Note: Channels cannot be entered
CLEARM	Clear mark in own channel Note: Channels cannot be entered.

Note

Inserting WAIT marks in additional programs

Using the "Copy" and "Paste" softkeys, you have the option to insert the blocks with WAIT marks into other programs for other channels.

Procedure



1. The multi-channel program has been created.
2. Place the cursor at the location of the program where you want to set the WAIT mark.
3. Press the "Various", "Continue", and "WAIT mark" softkeys. The "WAIT mark" window is opened.

4. In the "Type" selection box, select the desired WAIT mark.
5. If necessary, in the entry field, enter the desired number.
6. In the associated selection field of a channel, select "Yes" if the WAIT mark for this channel is to be valid.
7. Press the "Accept" softkey. The WAIT mark is displayed in the program as machining step. Using "Cursor right", as usual, open the machining step in the editor.

Editing a WAIT mark



+



Press the keys <SHIFT> and <INSERT > to open the WAIT mark and edit it.

11.2.9 Optimizing the machining time

After the simulation or processing of the program in automatic mode, the measured processing time of the program blocks are displayed to you depending on the setting.





For a multi-channel display, the wait times that occur are displayed at the wait points (WAIT marks). This provides you with an overview of the time sequence of the program and you can perform the first optimization runs.

At the end of the program, the total runtime for each channel is shown.

The actual time is recorded during time measurement, i.e. override and similar actions are included in the time measurement.

Shifting blocks

You have the option of shifting program blocks to longer wait points - assuming that the machining technology permits this - therefore reducing the machining time.

1. Select the block that you wish to shift.
2. Press the "Mark" softkey.

3. Press the "Copy" softkey if you wish to repeat the machining step at another position.

- OR -
Press the "Cut-out" softkey if you wish to execute the machining step at another position.

4. Position the cursor at the required program position and press the "Paste" softkey.

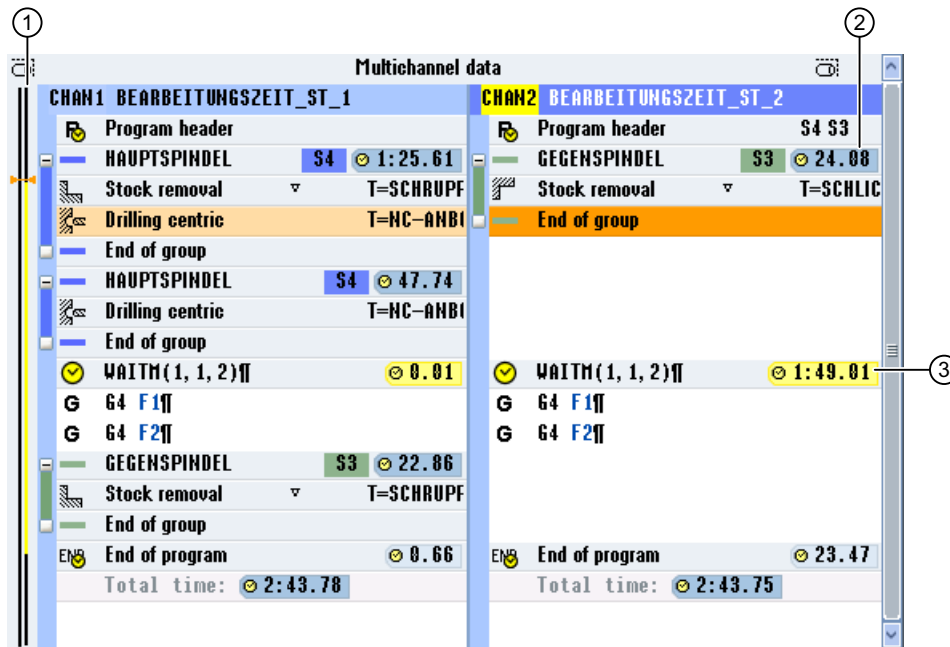
The program block is inserted at the required position.

Time-related view

In the time-related view, the wait times at the WAIT marks as well as the required machining times at the machining sections are displayed. If you change the program, time data is still displayed at the corresponding WAIT marks or the corresponding blocks dimmed.

The determined times are lost if you exit the editor using the "Close" softkey or you open or select another program. The times must be determined again through simulation.



- ① Timeline for each displayed channel
Processing times are displayed in black, wait times in yellow.
The actual cursor position is highlighted in orange.
- ② Machining time
- ③ Wait time for the parallel program

Figure 11-2 Time synchronous view

See also

- Editor settings (Page 182)
- Setting for automatic mode (Page 227)

11.2.10 Automatic block building

11.2.10.1 Creating automated program blocks

With the "Automatic block building" function, you have a convenient option to automatically split an existing program subsequently into the desired blocks.

Rules for creating the blocks

You define the rules for creating the blocks in the configuration file.

You can define the following program steps for better processing:

- Combine the tools used in the program into blocks
- Define cycle types
 - A main block opens a new block at the top level. The block itself is entered as first block in the block. The replacement text from the configuration file is taken as block text.
 - A subblock is inserted in the currently opened block of a main block. Blocks that are not classified by the configuration file are combined in one block at the second block level. This block contains the block text "Free DIN code".
 - Two levels are available for the block building to structure the program.

Note

The automatic block building can only be performed once.

If you use the function a second time, a message is displayed that no blocks can be inserted as some already exist.

In order to create blocks in the already converted program, use the "Build block" softkey in the editor.

References

For additional information, please refer to the following references:

SINUMERIK Operate Commissioning Manual

Precondition

The configuration file seditor.ini has been installed.

Procedure



1. Select the "Program manager" operating area.



2. Position the cursor on the required main program (*.mpf) or on a job list (*.job).
3. Press the ">>" and "Automat." block building" softkey.
You are prompted as to whether you want to automatically insert blocks in the program.

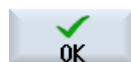

4. Press the "OK" softkey to confirm the conversion.

11.2.10.2 Editing a converted program

Precondition

You have used the "Automatic block formation" softkey to convert a program into a structured program.

Procedure

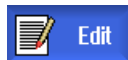

1. Open a converted program.

Opening and closing blocks



2. Press the ">>" and "View" softkeys.



3. Press the "Open blocks" softkey.
All blocks on the first level are opened.
To open the blocks on the second level, press the "Open blocks" softkey again.



4. Press the "Close blocks" softkey.
Opened blocks on the second level are closed.
To close the blocks on the first level, press the "Close blocks" softkey again.

Note: If all blocks on the second level are closed, the blocks on the first level are closed the first time the softkey is pressed.

Creating additional blocks manually in two planes



2. Mark the program records that you want to block subsequently to form a block and press the "Form block" softkey.



3. Enter a designation for the block in the "Form new block" window, assign the spindle, if required, select the additional run-in code and the automatic retraction, and press the "Accept" softkey.



4. If you want to group additional program records within the block to form a block, expand the block, e.g. with the "Expand blocks" softkey.



5. Mark the required program records within the block and press the "Form block" softkey.



6. Enter the required data in the "Form new block" window and press the "Accept" softkey.

Note:

If a spindle has already been assigned to the outer block, you can no longer assign any spindle to the inner block and vice versa.

Creating a block of the first plane with a higher-level block



2. Mark the required block that does not contain any other blocks and press the "Form block" softkey.
3. Enter the required data in the "Form new block" window and press the "Accept" softkey.

Note:

If a spindle has already been assigned to the marked block, you cannot assign any spindle to the newly created block.

11.2.11 Simulating machining

11.2.11.1 Simulation

For classic lathes with main and counterspindle, up to two channels can be simultaneously simulated.

You have the option of executing the programs together before the actual machining. In this case, start, stop and reset - as well as the functions to control the program, act simultaneously on all of the simulated channels.

Correction of the zero offsets for multi-channel data

If you use multi-channel data in the simulation, then the zero offsets are temporarily corrected so that they match the blank and the spindle chuck data.

Preconditions

The function of the individual spindles and special axes, must be specified in the display machine data set-up for the purpose.



Machine manufacturer

Please refer to the machine manufacturer's specifications.





Tool paths

Only the tool paths of the presently selected channel are displayed.

Procedure



1. Start the simulation.
 2. Press the "Main spindle" softkey if you wish to view the main spindle.
- OR -
3. Press the "Counterspindle" softkey if you wish to view the counterspindle.

- 
- 
- 
- 
- 
4. If you have pressed the "Main spindle" and "Counterspindle" softkeys, the simulation view is split into two and you can see the main spindle and counterspindle simultaneously.
 5. To toggle between the various channels, press the ">>" softkey and the "Channel +" or "Channel -" softkey.
The status line informs you about the channel presently being processed.





11.2.11.2 Different workpiece views for multi-channel support

In the graphical display, you can choose between different views so that you constantly have the best view of the current workpiece machining, or in order to display details or the overall view of the finished workpiece.

The following views are available:

- Side view
- Half section
- Front view
- 3D view
- 2-window

Procedure

- 
- 
- 
- 
- 
1. Start the simulation.
 2. Press the "Views" softkey.
 3. Press the "Side view" softkey if you wish to view the workpiece in the Z-X plane.
- OR -
Press the "Half section" softkey if you wish to view the workpiece cut in the Z-X plane.
- OR -
Press the "Front view" softkey if you wish to view the workpiece in the X-Y plane.
- OR -
Press the "3D view" softkey if you wish to view the workpiece as a three-dimensional model.



- OR -

Press the 2-window softkey if you wish to simultaneously view the side view (left-hand window) and front view (right-hand window) of the workpiece.

Note

The 2-window view cannot be activated if you have simultaneously selected the main spindle and the counterspindle.

11.2.12 Display/edit the multi-channel functionality in the "Machine" operating area

11.2.12.1 Running-in a program

You have various options to run-in programs.

Running-in channel-by-channel

Select the channels that you wish to process using the "Running-in" function in the "Program control" window. The channels not selected here are brought into the "Program test (PRT)" state. As a consequence, the channels are only calculated, but are not processed.

No M and auxiliary functions or tool functions are output. Spindle commands are only output for selected spindles.

Running-in spindle-by-spindle

Only machining operations are executed for the spindle selected under program control / running-in. When programming, using the block formation, allocate the corresponding machining operations to a spindle.

When generating a block, a complete block can be assigned to a spindle. For the case that the group is not executed, as the specified spindle should not be considered when running in, then it is possible to temporarily activate what is known as "Addit. run-in code".



Software options

You require the "programSYNC" option for cross-channel program control.

Precondition

- Multi-channel machine
- You have selected the multi-channel view via "Settings for channel functionalities".

Procedure



1. Select the "AUTO" operating area.
2. Press the "Prog. ctrl." softkey.



The "Program control - General" window appears on the screen.



3. Press the "Run-in" softkey.
The "Program control - Running-in" window is displayed.
4. Select the channels and the associated spindles to run-in the program.

11.2.12.2 Block search and program control

You define a group of channels that belong to one another from the "Settings for Multi-channel Functionality" window. Here, you specify which channel numbers should be displayed for a multi-channel view.

This group results in a common behavior for a block search and for program control.

Vertical softkeys for a block search

- The "Block search" and "Search mode" functions act on all channels, which you configured for the multi-channel view.
- All other vertical softkeys (e.g. "Search text", "Interrupt position", etc.) act on the current program.

If you selected the single-channel view in the multi-channel function settings, then all of the actions only act on the actual channel.



Software options

You require the "programSYNC" option for the multi-channel block search and the multi-channel program control in the multi-channel editor.



Machine manufacturer

Please refer to the machine manufacturer's specifications.

Procedure



1. Press the "Block search" softkey.



Press the "Search mode" softkey.
The "Search Mode" window is displayed.

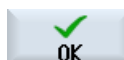

2. Select the required mode for the channel group.
3. Press the "OK" softkey to confirm the setting.



4. Press the "Search text" softkey if you wish to enter the search target using a text.



- OR -

Press the "Interrupt position" softkey if you wish to search for the search target using a program interrupt.



- OR -

Press the "Search pointer" softkey if you wish to enter a search target that you cannot enter using the editor (e.g. no interrupt position, search target is located in the subprogram) and enter the program path.



5. Press the "Start search" softkey.

The search starts.

All channels of the group are started corresponding to the search mode that has been set.

During the block search, the search states are displayed in a message window (e.g. "Block search running").

You receive a message if the search target has been reached - or an error message if the search target was not found.

Note

Block search mode "with program test"

For multi-channel programs, the block search mode should be used with "with program test", as this takes into account the synchronization between the programs.

Note

Search target via "Search pointer"

The "Search Pointer" window is displayed - as usual - over the complete lower part of the screen. The upper contents of the window remain multi-channel.

The actual channel is displayed in the title bar of the "Search Pointer" window.

The "Delete search pointer" also only acts on this channel.

Note

Search target via "Search text"

If, for a block search, you approach the program position using "Search text", please note that a search is only made in the selected channel column.

11.2.13 Stock removal with 2 synchronized channels

With multi-channel lathes, you have the option of simultaneously machining with 2 channels (4 axes).

The tools are located in front of and behind the center of rotation, and machine the same workpiece. For sufficiently long cuts, these are simultaneously used at different depth infeeds, with a specified offset.

The advantage is that you reduce your production time. Further, when machining, the cutting forces are better distributed.

Technological function

2-channel machining is available for the "Parallel stock removal" technology.

Leading channel/following channel

Define the leading channel when programming workpieces that you wish to machine utilizing multiple channels. As a consequence, you define the channel-specific machine and setting data that are used to create the stock removal programs.

Turning always starts in the leading channel. The second channel, also known as the following channel, starts with the second depth infeed as soon as the leading channel has removed stock by a specified "stock removal distance" (offset). If cuts are obtained that are shorter than this offset, then machining is only carried out in the leading channel.

Offset

If the offset is not equal to zero, then a dedicated stock removal program is generated for each channel. Automatically generated WAIT commands are used to synchronize both programs.

If the offset is equal to zero, then only one stock removal program is generated. This program is started in the leading channel. Axis coupling is used to generate the motion of the following channel.

For multi-channel lathes, the name of the generated stock removal program is extended by identifier "_C" with a subsequent two-digit channel number.

Roughing

When roughing, typically there is an offset between the channels when machining (channel offset DCH).

- When the parameter is positive, then the leading channel machining is executed before the following channel by the channel offset.
- When the parameter is negative, then the machining sequence is interchanged. The program generated for the leading channel is in this case, started in the following channel.
- When the parameter is equal to zero, then the workpiece is machined without offset (refer to the paragraph "Finishing balance cutting").

Note

Constant cutting rate

When using a constant cutting rate, ensure that the offset (DCH) is not too high.

Tools

The difference between the two cutting radii of the tools must not exceed the allowance.

Finishing

2-channel finish cutting is only possible with Balance Cutting.

Only one machining program is generated for the leading channel, and this is executed there. The motion in the following channel is coupled to this motion.

Balance Cutting

Balance Cutting involves symmetrical machining in both channels. In so doing, the cutting forces are evenly distributed between both sides of the workpiece. The tools are opposite one another at the same infeed depth.



Machine manufacturer

Please refer to the machine manufacturer's specifications on the subject of axis coupling.

Note

Tools

The tool radii or cutting plate widths of the plunging tools must be the same size.

General conditions

- For internal machining operations ensure that collisions do not occur between the tools and/or tool carriers. The control cannot ensure this, as it has no information about the mechanical dimensions.
- Before machining for the first time, position the tools so that they are in approximately in the same position.
- The tools must have the same cutting-edge position and cutting direction in both channels.
- The following parameters and settings must be the same in both channels:
 - the machining plane (G17, G18, G19),
 - the technology (stock removal),
 - the machining (roughing, finishing),
 - the dimension unit (metric, inch).

11.2.13.1 Job list

One example for a ShopTurn and one for a G Code job list are described in the following.

The clock symbol in the icon of the program blocks indicates that internal WAIT commands are used to synchronize the channels involved. The cycles perform the synchronization.

ShopTurn machining schedule

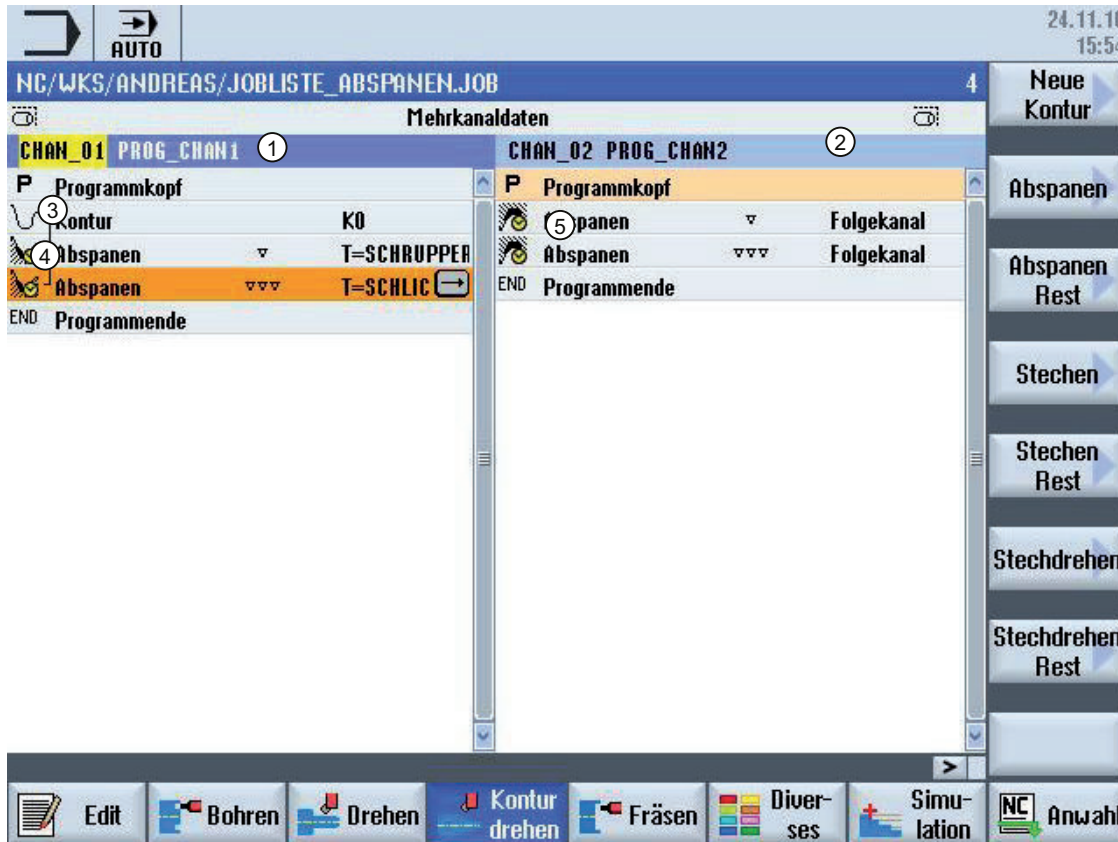

- 1) Machining program in the leading channel
- 2) Machining program in the following channel
- 3) Contour and machining steps in the leading channel have a bracket symbol
- 4) 2-channel steps; implicit WAIT marks are identified using a clock symbol.
- 5) The contour is only defined in the leading channel; this is the reason that there is no bracket here.

Figure 11-3 View of a 2-channel stock removal program in ShopTurn

Program view in the G code

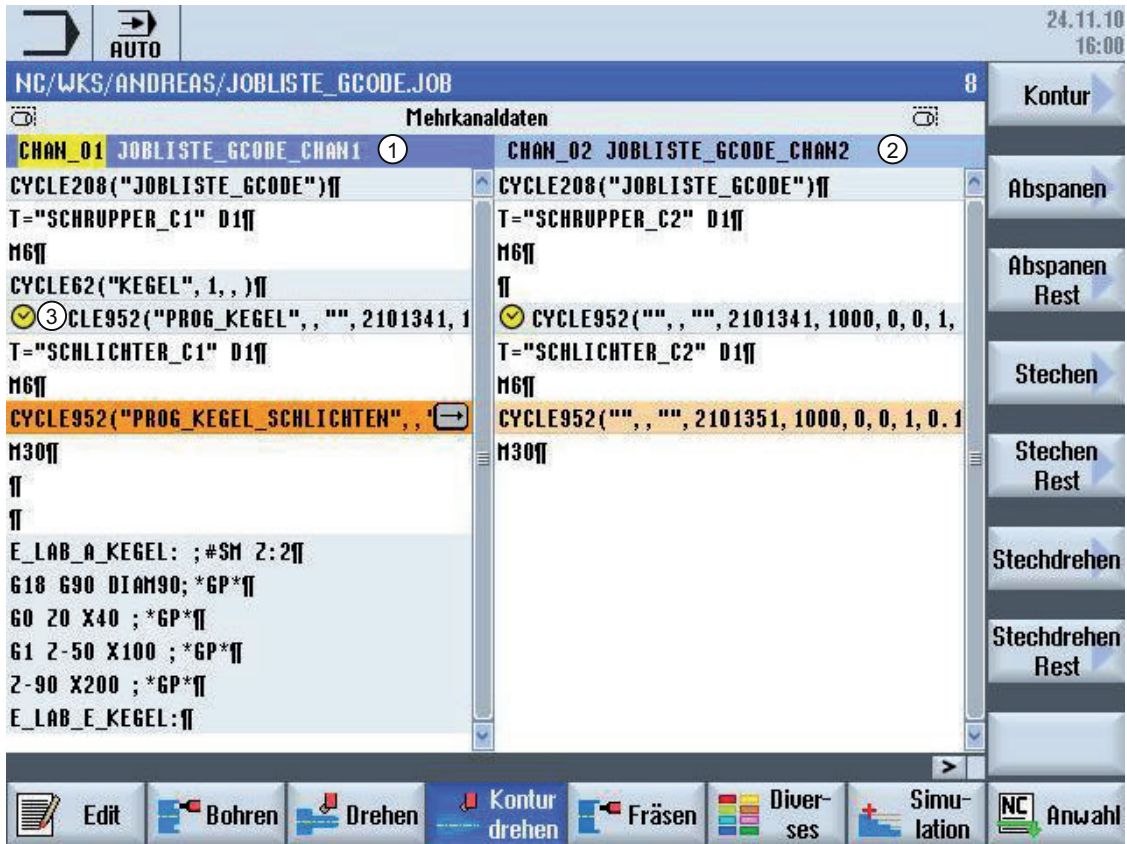

- 1) Machining program in the leading channel
- 2) Machining program in the following channel
- 3) 2-channel stock removal cycles, which contain implicit WAIT marks, are identified by a preceding clock symbol.

Figure 11-4 View of a 2-channel stock removal program in G code

11.2.13.2 Stock removal

Calling up the cycle

Precondition

- "programSYNC" option

Procedure



1. The part program or ShopTurn program to be processed has been created and you are in the editor.
2. Press the "Contour turning" softkey.
3. Press the "Stock removal" softkey.

Only those parameters relevant for stock removal with 2 synchronized channels of a workpiece are subsequently described. All other parameters are described in Chapter "Contour turning".

Parameters

Parameter	Description	Unit
Machining 	<ul style="list-style-type: none"> • ∇ 2 CHAN 2-channel roughing • ∇∇∇ 2 CHAN 2-channel finishing 	
Channel 	<p>Defines whether the currently set channel is the leading or following channel. All calculations are carried out in the leading channel.</p>	
Number 	<p>Selecting the number of the partner channel if there are more than 2 channels available.</p> <ul style="list-style-type: none"> • If, for the channel parameter, "Leading channel" is selected, then the channel number of the following channel must be parameterized here. • If, for the channel parameter, "Following channel" is selected, then the channel number of the leading channel must be parameterized here. 	
DCH 	<p>Channel offset</p> <ul style="list-style-type: none"> • For positive parameters, then the leading channel machining is executed before the following channel by the channel offset. • For a negative parameter, when executing the program, the leading or following channel property is interchanged. • If the parameter is equal to zero, then balance cutting (axis coupling) is used. 	mm (inch)

11.2.14 Synchronizing a counterspindle

For multi-channel machines, the counter-spindle steps must be synchronized across all channels.

You program handling the counter-spindle in one channel. This channel controls the motion of the counter-spindle and adapts the zero offset of the channel.

In the synchronization step, the other channels park their tools in order to avoid collisions. The zero offset is also accepted.

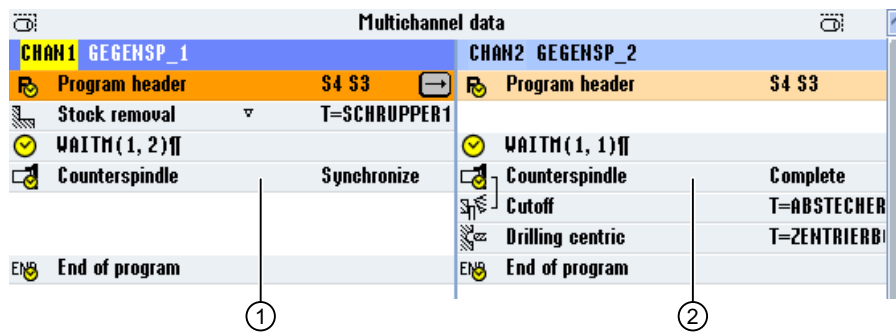









- ① Synchronization step
- ② Counter-spindle step



The following counter-spindle steps, which implicitly contain WAIT marks, are identified using a symbol:









- Pulling (take zero point = yes)
- Machining side
- Complete transfer
- Synchronizing

Parameters	Description	Unit
Function 	You can select one of the following functions: <ul style="list-style-type: none"> • Synchronizing • Complete transfer • Gripping • Withdrawing • Machining side 	
Workpiece machining	<ul style="list-style-type: none"> • Main spindle in counter-spindle • Counter-spindle in main spindle 	
Synchronization function	Synchronizes with the counter-spindle in the other channel.	
Coordinate system	<ul style="list-style-type: none"> • MCS The park position is specified in the machine coordinate system. Teaching in the park position and angular offset is only possible in the machine coordinate system. • Workpiece coordinate system The park position is specified in the workpiece coordinate system. 	
XP	Park position of tool in X direction (abs)	mm
ZP	Park position of tool in Z direction (abs)	mm
Complete transfer function	Gripping	

Parameters	Description	Unit
Coordinate system 	<ul style="list-style-type: none"> • MCS The park position is specified in the machine coordinate system. Teaching in the park position and angular offset is only possible in the machine coordinate system. • WCS The park position is specified in the workpiece coordinate system. 	
XP	Park position of tool in X direction (abs)	mm
ZP	Park position of tool in Z direction (abs)	mm
Flush chuck 	Flush counter-spindle chuck <ul style="list-style-type: none"> • Yes • No 	
DIR 	Direction of rotation <ul style="list-style-type: none"> •  Spindle rotates clockwise •  Spindle rotates counter-clockwise •  Spindle does not rotate 	
S	Spindle speed – (only when the spindle rotates)	rev/min
$\alpha 1$	Angular offset	Degrees
Z1	Transfer position (abs.)	
ZR 	Position, feedrate reduction (abs or inc) Position from which a reduced feedrate is used.	
FR	Reduced feedrate	mm/rev
Fixed stop	Travel to fixed stop <ul style="list-style-type: none"> • Yes The counter-spindle stops at a defined distance away from transfer position Z1 and then traverses with a defined feedrate up to the fixed stop. • No The counter-spindle traverses to the transfer position Z1. 	
Complete transfer function	Withdrawing	
Withdraw blank	Withdraw complete blank: <ul style="list-style-type: none"> • Yes • No 	
F	Feed (only when "yes" for "withdraw blank")	mm/min
Cutting-off cycle	Cutting-off cycle in the following block <ul style="list-style-type: none"> • Yes • No 	
Complete transfer function	Rear side (for main spindle in counter-spindle)	



Parameters	Description	Unit
Work offset 	Work offset in which the coordinate system, which was shifted according to ZW and by ZV as well as mirrored in Z, must be saved: <ul style="list-style-type: none"> • Basic reference • G54 • G55 • G56 • G57 • ... 	
Write to the work offset	<ul style="list-style-type: none"> • Yes The Z value of the work offset can be directly written to the input screen form. • No The actual Z value of the work offset is used. 	
ZV - only for work offset write "yes"	<ul style="list-style-type: none"> • Offset Z = 0 (abs) • Workpiece zero is offset in Z direction (inc, the sign is also evaluated) 	mm
Z4W	Supplementary axis of the counter-spindle machining position (abs); MCS	mm
Complete transfer function	Front side (for counter-spindle in main spindle)	
Work offset 	Work offset in which the coordinate system, which was shifted according to ZP and by ZV as well as mirrored in Z, must be saved: Basic reference G54 G55 G56 G57 ...	
Work offset write to	<ul style="list-style-type: none"> • Yes The Z value of the work offset can be directly written to the input screen form. • No The actual Z value of the work offset is used. 	
ZV - only for work offset write "yes"	<ul style="list-style-type: none"> • Z value of the work offset (abs) • Workpiece zero offset in the Z direction (inc); the sign is also evaluated. 	mm
Z4P	Park position of the counter-spindle supplementary axis (abs); MCS	mm

Parameters	Description	Unit
Function, gripping	Teaching in the park position and angular offset is possible	
Gripping a blank 	<ul style="list-style-type: none"> • With counter-spindle The blank is gripped with the counter-spindle • With main spindle The blank is gripped with the main spindle 	
Also take zero point 	<ul style="list-style-type: none"> • Yes • No 	

Parameters	Description	Unit
Work offset  - for take zero point "yes"	Work offset in which the coordinate system offset by Z1 must be saved. Basic reference G54 G55 G56 G57 ...	
Coordinate system 	<ul style="list-style-type: none"> • MCS The park position is specified in the machine coordinate system. Teaching in the park position and angular offset is only possible in the machine coordinate system. • WCS The park position is specified in the workpiece coordinate system. 	
XP	Park position of tool in X direction (abs)	mm
ZP	Park position of tool in Z direction (abs)	mm
Flush chuck 	Flush counter-spindle chuck <ul style="list-style-type: none"> • Yes • No 	
DIR 	Direction of rotation <ul style="list-style-type: none"> •  Spindle rotates clockwise •  Spindle rotates counter-clockwise •  Spindle does not rotate 	
S	Spindle speed – (only when the spindles rotate)	rev/min
$\alpha 1$	Angular offset	Degrees
Z1	Transfer position (abs.)	
ZR 	Position, feedrate reduction (abs or inc) Position from which a reduced feedrate is used.	
FR	Reduced feedrate	mm/rev
Fixed stop	Travel to fixed stop <ul style="list-style-type: none"> • Yes The counter-spindle stops at a defined distance away from transfer position Z1 and then traverses with a defined feedrate up to the fixed stop. • No The counter-spindle traverses to the transfer position Z1. 	

Parameters	Description	Unit
Function, withdrawing		
Withdraw blank	<ul style="list-style-type: none"> • From main spindle • From counter-spindle 	
Also take zero point 	Also take zero point <ul style="list-style-type: none"> • Yes • No 	

Parameters	Description	Unit
Work offset  - for take zero point "yes"	Work offset in which the coordinate system offset by Z1 must be saved. <ul style="list-style-type: none"> • Basic reference • G54 • G55 • G56 • G57 • ... 	
Z1	Amount by which the workpiece is withdrawn from the main spindle (inc)	
F	Feedrate	mm/min

Parameters	Description	Unit
Machining side function		
Spindle selection 	<ul style="list-style-type: none"> • Main spindle Machining along the main spindle • Counter-spindle Machining along the counter-spindle 	
Work offset 	Work offset in which the coordinate system, which was shifted according to ZW and by ZV as well as mirrored in Z, must be saved: <ul style="list-style-type: none"> • Basic reference • G54 • G55 • G56 • G57 • ... 	
Work offset write to 	<ul style="list-style-type: none"> • Yes The Z value of the work offset can be directly written to the input screen form. • No The actual Z value of the work offset is used. 	
ZV - only for work offset write "yes"	<ul style="list-style-type: none"> • Offset Z = 0 • Workpiece zero is offset in Z direction (inc, the sign is also evaluated) 	
Park counter-spindle	Traverse counter-spindle to park position - for "main spindle" selection <ul style="list-style-type: none"> • Yes • No 	
Z4P - for park counter- spindle "yes"	Park position of the counter-spindle (abs); MCS	mm
Z4W	Machining position of the counter-spindle (abs); MCS	mm

Collision avoidance

Collision avoidance allows you to avoid collisions and damage while machining a workpiece or creating programs.



Software option

You require the "Collision Avoidance ECO (machine)" software option in order to use this function for geometrically primitive protection area elements.



Software option

You require the "Collision Avoidance (machine, working area)" software option in order to use this function additionally for protection area elements in the STL and NPP data formats.
(840D sl only)



Software option

You require the "Collision Avoidance ADVANCED (machine, workpiece)" software option in order to use this function additionally for the autonomous realization of collision avoidance application.
(840D sl only)



Machine manufacturer

Please refer to the machine manufacturer's specifications.

Collision avoidance is based on a machine model. The kinematics of the machine are described as a kinematic chain. For machine parts to be protected, protection areas are attached to these chains. The geometry of the protection areas is defined using protection area elements. The control then knows how they move in the machine coordinate system depending on the position of the machine axes. You then subsequently define the collision pairs, i.e. two protection areas, which are monitored with respect to one another.

The "Collision avoidance" function regularly calculates the clearance from these protection areas. When two protection areas approach one another and a specific safety clearance is reached, an alarm is displayed and the program is stopped before the corresponding traversing block and/or the traversing motion is stopped.

Note

The collision monitoring is only valid for single-channel machines.

Note

Referenced axes

The positions of the axes in the machine area must be known so that the protection areas can be monitored. For this reason, collision avoidance is only active after the referencing.

NOTICE

No complete machine protection

Incomplete models, e.g. machine parts, workpieces that have not been modeled or new objects in the working area, are not monitored and can therefore cause collisions.

References

More detailed explanations of collision avoidance can be found in the following reference:

Special Functions Function Manual:

- Section: "Kinematic chain (K7)"
- Section: "Geometric machine modeling (K8)"
- Section: "Collision avoidance, internal (K9)"
- Section: "Collision avoidance, external (K11)"

12.1 Activating collision avoidance

Precondition

- Collision avoidance is setup and an active machine model (kinematic chains) is available.
- The setting "Collision avoidance" has been selected for the AUTO operating mode or for the JOG and MDA operating modes.

Procedure



1. Select the "Machine" operating area



2. Press the <AUTO> key.



3. Press the "Sim. rec." softkey.



4. Press the "Other views" and "Machine area" softkeys.



An active machine model (kinematic chains) is displayed for simultaneous recording.

12.2 Set collision avoidance

Using "Settings", you have the option of separately activating or deactivating the collision monitoring for the Machine operating area (operating modes, AUTO, JOG and MDI) separately for the machine and tools.

Using machine data, you define from which protection level the collision avoidance for the machine or the tool can be activated or deactivated in the operating modes JOG/MDI or AUTO.



Machine manufacturer

Please refer to the machine manufacturer's specifications.

Setting	Effect
JOG/MDI operating mode Collision avoidance	They switch the collision avoidance for the operating modes JOG/MDI completely on or off.
AUTO mode Collision avoidance	They switch the collision avoidance for the operating mode AUTO completely on or off.
JOG/MDI Machine	If the collision monitoring for the JOG/MDI operating modes is activated, then as a minimum, the machine protection areas are monitored. The parameter cannot be changed.
AUTO Machine	If the collision monitoring for the AUTO operating mode is activated, then as a minimum, the machine protection areas are monitored. The parameter cannot be changed.
JOG/MDI Tools	They switch the collision avoidance of the tool protection areas for the operating modes JOG/MDI on or off.
AUTO Tools	They switch the collision avoidance of the tool protection areas for the operating mode AUTO on or off.

Procedure



1. Select the "Machine" operating area.



2. Select the "JOG", "MDI" or "AUTO" mode.





3. Press the menu forward key and the "Settings" softkey.



4. Press the "Collision avoidance" softkey.
The "Collision Avoidance" window opens.



5. In the "Collision avoidance" line for the required operating modes (e.g. for JOG/MDI), select the entry "On" to activate the collision avoidance or "Off" to deactivate collision avoidance.
6. Deactivate the "Tools" checkbox if you only want to monitor the machine protection areas.

Tool management

13.1 Lists for the tool management

All tools and also all magazine locations that have been created or configured in the NC are displayed in the lists in the Tool area.

All lists display the same tools in the same order. When switching between the lists, the cursor remains on the same tool in the same screen segment.

The lists have different parameters and softkey assignments. Switching between lists is a specific change from one topic to the next.

- **Tool list**
All parameters and functions required to create and set up tools are displayed.
- **Tool wear**
All parameters and functions that are required during operation, e.g. wear and monitoring functions, are listed here.
- **Magazine**
You will find the magazine and magazine location-related parameters and functions for the tools / magazine locations here.
- **Tool data OEM**
This list can be freely defined by the OEM.

Sorting the lists

You can change the sorting within the lists according to:

- The magazine
- The name (tool identifier, alphabetic)
- The tool type
- The T number (tool identifier, numerical)
- The D number

Filtering the lists

You can filter the lists according to the following criteria:

- Only display the first cutting edge
- Only tools that are ready to use
- Only tools that have reached the pre-alarm limit
- Only locked tools
- Only tools with active code

13.1 Lists for the tool management

Search functions

You have the option of searching through the lists according to the following objects:

- Tool
- Magazine location
- Empty location

13.2 Magazine management

Depending on the configuration, the tool lists support a magazine management.

Magazine management functions

- Press the "Magazine" horizontal softkey to obtain a list that displays tools with magazine-related data.
- The Magazine / Magazine location column is displayed in the lists.
- In the default setting, the lists are displayed sorted according to magazine location.
- The magazine selected via the cursor is displayed in the title line of each list.
- The "Magazine selection" vertical softkey is displayed in the tool list.
- You can load and unload tools to and from a magazine via the tool list.



Machine manufacturer

Please refer to the machine manufacturer's specifications.

13.3 Tool types

A number of tool types are available when you create a new tool. The tool type determines which geometry data is required and how it will be computed.

Tool types

New tool - favorites		
Type	Identifier	Tool position
500	- Roughing tool	
510	- Finishing tool	
520	- Plunge cutter	
540	- Threading tool	
550	- Button tool	
560	- Rotary drill	
580	- 3D turning probe	
730	- Stop	
120	- End mill	
140	- Facing tool	
150	- Side mill	
200	- Twist drill	
240	- Tap	
	Multitool	

Figure 13-1 Example of Favorites list

New tool - milling cutter		
Typ	Identifier	Tool position
100	- Milling tool	
110	- Cylindr. ball end	
111	- Conical ball end	
120	- End mill	
121	- End mill corner round.	
130	- Angle head cutter	
131	- Corn.round.ang.hd.cut	
140	- Facing tool	
145	- Thread cutter	
150	- Side mill	
151	- Saw	
155	- Bevelled cutter	
156	- Beveled cutter corner	
157	- Tap. die- sink. cutter	
160	- Drill&thread cut.	

Figure 13-2 Available tools in the "New Tool - Milling Cutter" window

New tool - drill		
Typ	Identifier	Tool position
200	Twist drill	
205	Solid drill	
210	Boring bar	
220	Center drill	
230	Countersink	
231	Counterbore	
240	Tap	
241	Fine tap	
242	Tap, Whitworth	
250	Reamer	

Figure 13-3 Available tools in the "New Tool - Drill" window

New tool - turning tools		
Type	Identifier	Tool position
500	Roughing tool	
510	Finishing tool	
520	Plunge cutter	
530	Cutting tool	
540	Threading tool	
550	Button tool	
560	Rotary drill	
580	3D turning probe	
585	Calibrating tool	

Figure 13-4 Available tools in the "New Tool - Turning Tools" window

New tool - special tools		
Type	Identifier	Tool position
700	Slotting saw	
710	3D probe	
711	Edge finder	
712	Mono probe	
713	L probe	
714	Star probe	
725	Calibrating tool	
730	Stop	
731	Mandrel	
732	Steady rest	

Figure 13-5 Available tools in the "New Tool - Special Tools" window

See also

Changing the cutting edge position or tool type (Page 752)

13.4 Tool dimensioning

This section provides an overview of the dimensioning of tools.

Tool types

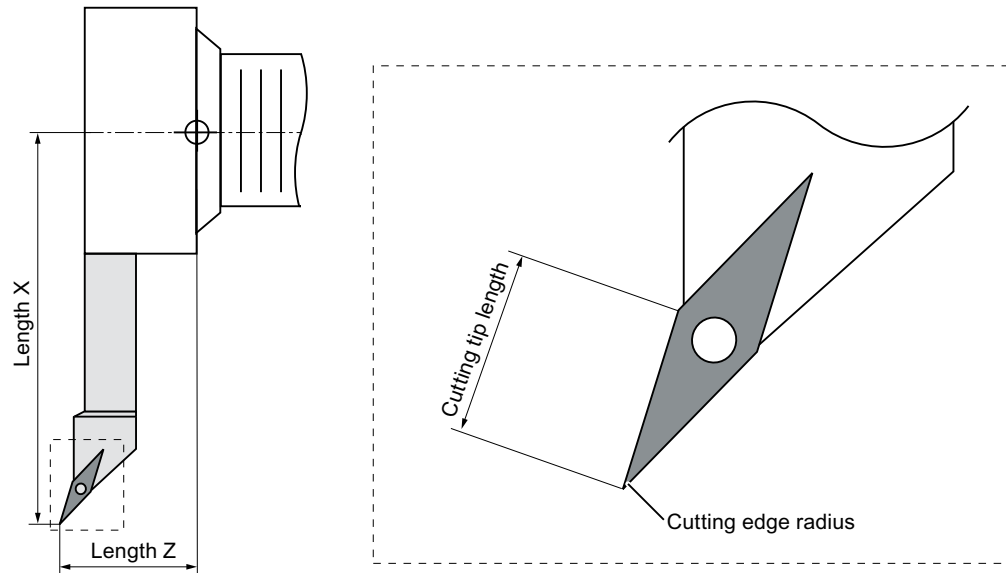

Figure 13-6 Finishing tool (Type 510)

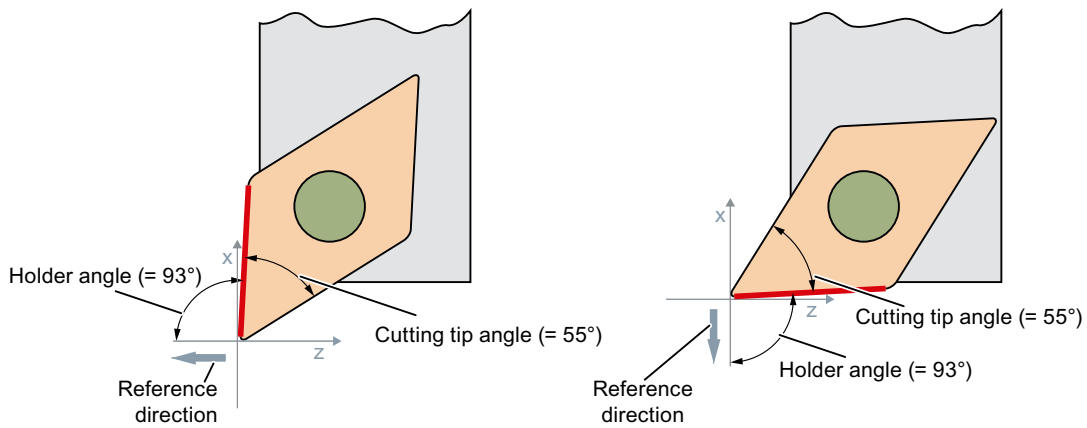

Figure 13-7 Angle descriptions

13.4 Tool dimensioning

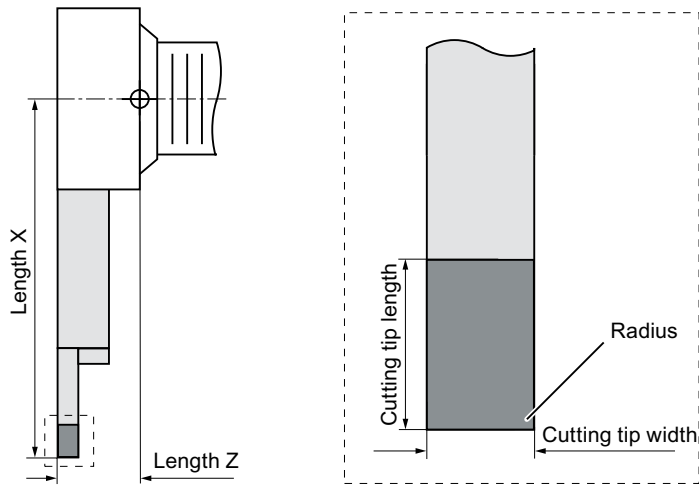

Figure 13-8 Plunge cutter (Type 520)

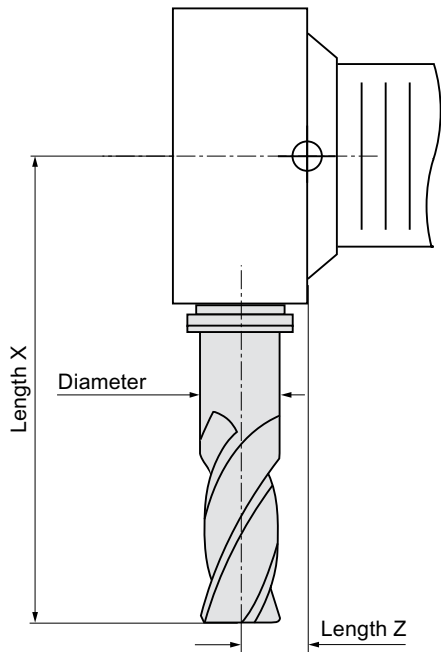

Figure 13-9 Milling cutter (Type 120)

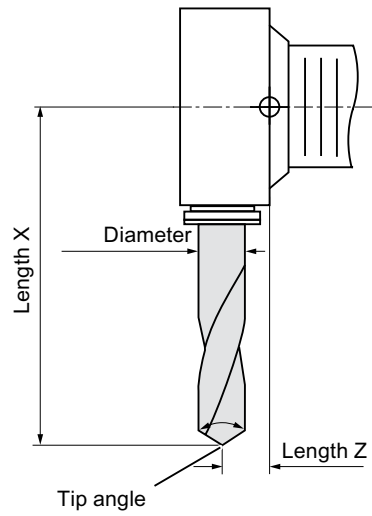

Figure 13-10 Drill (Type 200)

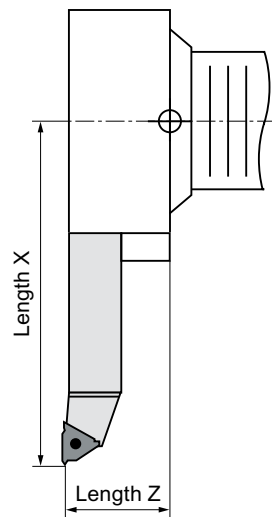

Figure 13-11 Threading tool (Type 540)

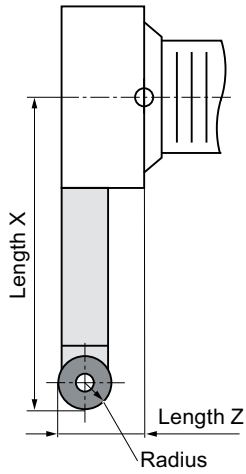

Figure 13-12 Button tool (Type 550)

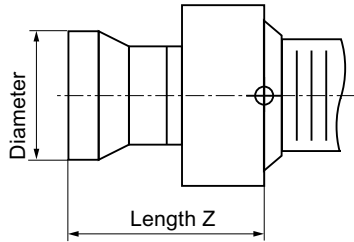

Figure 13-13 Stop (Type 730)

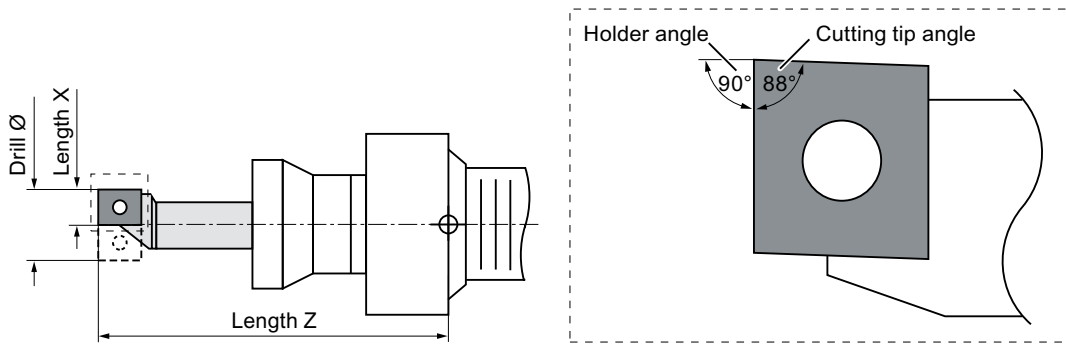

Figure 13-14 Rotary drill (Type 560)

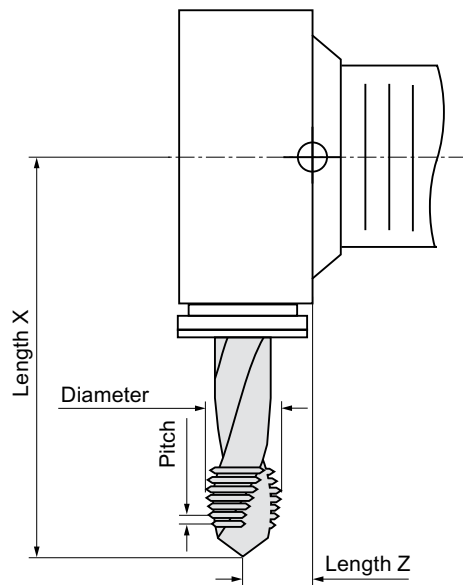

Figure 13-15 Tap (Type 240)

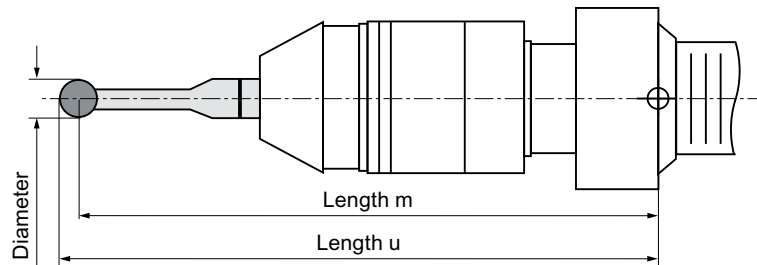

Figure 13-16 3D probe



Machine manufacturer

The tool length is measured to the center of the ball or to the ball circumference.
Please refer to the machine manufacturer's specifications.

Note

A 3D probe must be calibrated before use.



13.5 Tool list







All parameters and functions that are required to create and set up the tools are displayed in the tool list.

Each tool is uniquely identified by the tool identifier and the replacement tool number.

For the tool display, i.e. when displaying the cutting edge positions, the machine coordinate system is taken into account.

Tool parameters

Column heading	Meaning
Location	Magazine/location number <ul style="list-style-type: none"> The magazine location numbers The magazine number is specified first, followed by the location number in the magazine. If there is only one magazine, only the location number is displayed.
BS	<ul style="list-style-type: none"> Load position in the load magazine
 *  * * If activated in magazine selection	The following icons can also be displayed for other magazine types (e.g. for a chain): <ul style="list-style-type: none"> Spindle location as an icon Locations for gripper 1 and gripper 2 (applies only when a spindle with dual gripper is used) as icons.
Type	Tool type Specific tool offset data is displayed depending on the tool type (represented as an icon). The icon identifies the position of the tool; this was selected when the tool was created.
	You have the option of changing the tool position or the tool type using the <SELECT> key.
Tool name	The tool is identified by the name and the replacement tool number. You can enter the name as text or number. Note: The maximum length of tool names is 31 ASCII characters. The number of characters is reduced for Asian characters or Unicode characters. The following special characters are not permitted: # ".
ST	Replacement tool number (for replacement tool strategy).
D	Cutting edge number
Length X, length Z	Tool length Geometry data length X and length Z
Radius	Tool radius
∅	Tool diameter

Column heading	Meaning
Width/ Tip width/ Tip angle / Pitch Drilling radius	<p>Cutting edge for Type 150 - side milling cutter and Type 151 - saw</p> <p>Tip width for Type 520 - plunge cutter and Type 530 - cut-off tool</p> <p>Tip angle for Type 200 – twist drill and Type 220 – centering tool and Type 230 – countersink</p> <p>Pitch for Type 240 - tap</p> <p>Drilling radius for Type 560 - rotary drill. Holder angle and cutting tip angle are fixed.</p>
    	<p>Cutting edge graphic</p> <p>The cutting edge graphic shows the positioning defined by the holder angle, cut direction and cutting tip angle.</p> <p>Holder angle for Type 500 - rougher and Type 510 - finisher.</p> <p>The reference direction for the holder angle specifies the cut direction.</p> <p>In addition to the holder angle, the cutting tip angle is also specified.</p>
N	<p>Number of teeth for Type 110 - ball end mill for cylindrical die-sinking cutter, Type 111 - ball end mill for tapered die-sinking cutter, Type 120 - end mill, Type 121 - end mill with corner rounding, Type 130 - angle head cutter, Type 140 - facing tool, Type 150 - side mill, Type 155 - bevel cutter, Type 156 - bevel cutter with corner rounding, and Type 157 - tapered die-sinking cutter.</p>
Tip length	<p>Tip length of a cutting tool or grooving cutter</p> <p>The tip length is required for displaying the tools during the simulation of the program processing.</p>
	<p>Direction of spindle rotation</p> <p>The direction of the spindle's rotation is relative to the tool spindle for powered tools (drilling and milling machines) and to the main or counter-spindle for turning tools.</p> <p>If you are using a drilling or milling machine for "Drilling centric" or "Thread centric", the specified direction of rotation is relative to the cutting direction of the tool. The main spindle then rotates to match the tool.</p> <p> <input type="checkbox"/> Spindle is not switched on <input type="checkbox"/> CW spindle rotation <input type="checkbox"/> CCW spindle rotation </p>
	<p>Coolant 1 and 2 (e.g. internal and external cooling) can be switched on and off.</p> <p>The coolant infeed at the machine does not necessarily have to be set-up.</p>
M1 - M4	<p>Other tool-specific functions such as additional coolant infeed, monitoring functions for speed, tool breakage, etc.</p>

Further parameters

If you have set up unique cutting edge numbers, these are displayed in the first column.

Column heading	Meaning
D no.	Unique cutting edge number
SN	Cutting edge number
SC	Setup offsets
	Display of the existing setup offsets

You use the configuration file to specify the selection of parameters in the list.



Software option

In order to be able to manage the parameter spindle direction of rotation, coolant and tool-specific functions (M1-M4), you require the "ShopMill/ShopTurn" option.



Machine manufacturer

Please refer to the machine manufacturer's specifications.

Tool change / block search in the ShopTurn program step

If a tool is loaded in a ShopTurn program step, the corresponding M function for the coolant is automatically issued.



After a block search, the coolant specified here is output, even if a different coolant has been programmed, e.g. via G code, in the meantime.





References

Information on the configuration and setting up of the tool list can be found in the following references:

SINUMERIK Operate Commissioning Manual

Icons in the tool list

Icon/ Marking		Meaning
Tool type		
Red "X"		The tool is disabled.
Yellow triangle pointing downward		The prewarning limit has been reached.
Yellow triangle pointing upward		The tool is in a special state. Place the cursor on the marked tool. A tool tip will provide a brief description.

Icon/ Marking		Meaning
Green frame		The tool is preselected.
Magazine/location number		
Green double arrow		The magazine location is positioned at the change position.
Gray double arrow		The magazine location is positioned at the loading position.
Red "X"		The magazine location is disabled.



Machine manufacturer

Please refer to the machine manufacturer's specifications.

Procedure

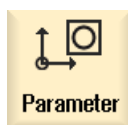

1. Select the "Parameter" operating area.



2. Press the "Tool list" softkey.
The "Tool List" window opens.

See also

Displaying tool details (Page 743)

Changing the cutting edge position or tool type (Page 752)

13.5.1 Additional data

The following tool types require geometry data that is not included in the tool list display.

Tool types with additional geometry data

Tool type	Additional parameters
111 Conical ballhead cutter	Corner radius
121 End mill with corner rounding	Corner radius
130 Angle head cutter	Geometry length (length X, length Y, length Z) Wear length (Δ length X, Δ length Y, Δ length Z) Adapter length (length X, length Y, length Z) V (direction vector 1 - 6) Vector X, vector Y, vector Z

Tool type	Additional parameters
131 Angle head cutter with corner rounding	Geometry length (length X, length Y, length Z) Corner radius Wear length (Δ length X, Δ length Y, Δ length Z) Adapter length (length X, length Y, length Z) V (direction vector 1 - 6) Vector X, vector Y, vector Z
140 Face milling	External radius Tool angle
155 Bevel cutter	Taper angle
156 Bevel cutter with corner rounding	Corner radius Taper angle
157 Conical die-milling cutter	Taper angle
700 slotting saw	Geometry length (length X, length Y, length Z) Wear length (Δ length X, Δ length Y, Δ length Z) Adapter length (length X, length Y, length Z) Geometry (slot width, projection) Wear (slot width, projection)

You can use the configuration file to specify the data to be displayed for specific tool types in the "Additional Data" window.



Machine manufacturer

Please refer to the machine manufacturer's specifications.

Procedure











1. The tool list is opened.
2. In the list, select an appropriate tool, e.g. an angle head cutter.
3. Press the "Additional data" softkey.
The "Additional Data - ..." window opens.
The "Additional data" softkey is only active if a tool for which the "Additional Data" window is configured is selected.

13.5.2 Creating a new tool

When creating a new tool, the "New tool - favorites" window offers you a number of selected tool types, known as "favorites".

If you do not find the desired tool type in the favorites list, then select the milling, drilling, turning or special tool via the corresponding softkeys.

Procedure

1.  The tool list is opened.
2. Place the cursor in the tool list at the position where the new tool should be stored.
For this, you can select an empty magazine location or the NC tool memory outside of the magazine.
You may also position the cursor on an existing tool in the area of the NC tool memory. Data from the displayed tool will not be overwritten.
3.  Press the "New tool" softkey.
 The "New tool - Favorites" window opens.
- OR -
 If you want to create a tool that is not in the Favorites list, press the "Cutters 100-199", "Drills 200-299", "Turning tools 500-599" or "Sp. tools 700-900" softkey.
...
 The "New Tool - Milling Cutters", "New Tool - Drills", "New Tool - Turning Tools" or "New Tool - Special Tools" window opens.
4. Select the tool by placing the cursor on the corresponding tool type and on the icon of the desired cutting edge position.
5.  If more than four cutting edge positions are available, select the desired cutting edge position with the aid of the <cursor left> and <cursor right> keys.

6.  Press the "OK" softkey.
The tool is added to the tool list with a predefined name. If the cursor is located on an empty magazine location in the tool list, then the tool is loaded to this magazine location.

The tool creation sequence can be defined differently.

Multiple load points

If you have configured several loading points for a magazine, then the "Select loading point" window appears when a tool is created directly in an empty magazine location or when the "Load" softkey is pressed.

Select the required load point and confirm with the "OK" softkey.

Additional data

If configured accordingly, the "New tool" window opens after the required tool has been selected and confirmed with "OK".

You can define the following data in this window:

- Names
- Tool location type
- Size of tool

References

For a description of configuration options, refer to the SINUMERIK Operate Commissioning Manual

13.5.3 Measuring the tool

You can measure the tool offset data for the individual tools directly from the tool list.

Note

Tool measurement is only possible with an active tool.

Procedure



1. The tool list is opened.



2. Select the tool that you want to measure in the tool list and press the "Measure tool" softkey.



You jump to the "JOG" operating area and the tool to be measured is entered in the "T" field in the "Length Manual" screen.



3. Select the cutting edge number D and the replacement tool number ST.



4. Press the "X" or "Z" softkey, depending on which tool length you want to measure.

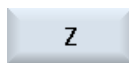

5. Traverse the tool towards the workpiece in the direction that is to be measured and scratch it.
6. Enter the position of the workpiece edge in X0 or Z0.
If no value is entered for X0 or Z0, the value is taken from the actual value display.



7. Press the "Set length" softkey.
The tool length is calculated automatically and entered in the tool list.

13.5.4 Managing several cutting edges

In the case of tools with more than one cutting edge, a separate set of offset data is assigned to each cutting edge. The number of possible cutting edges depends on the control configuration.

Tool cutting edges that are not required can be deleted.

Procedure



1. The tool list is opened.



2. Position the cursor on the tool for which you would like to store more cutting edges.



3. Press the "Cutting edges" softkey in the "Tool list".

4. Press the "New cutting edge" softkey.

A new data set is stored in the list.

The cutting edge number is incremented by 1 and the offset data is assigned the values of the cutting edge on which the cursor is positioned.

5. Enter the offset data for the second cutting edge.

6. Repeat this process if you wish to create more tool edge offset data.



7. Position the cursor on the cutting edge that you want to delete and press the "Delete cutting edge" softkey.

The data set is deleted from the list. The first tool cutting edge cannot be deleted.

13.5.5 Delete tool

Tools that are no longer in use can be deleted from the tool list for a clearer overview.

Procedure



1. The tool list is opened.



2. Place the cursor on the tool that you would like to delete.

3. Press the "Delete tool" softkey.

A safety prompt is displayed.

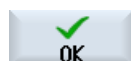

4. Press the "OK" softkey if you really want to delete the tool.

Use this softkey to delete the tool.

If the tool is in a magazine location, it is unloaded and then deleted.

Multiple load points - tool in magazine location

If you have configured several loading points for a magazine, then the "Loading Point Selection" window appears after pressing the "Delete tool" softkey.

Select the required load point and press the "OK" softkey to unload and delete the tool.

13.5.6 Loading and unloading tools

You can load and unload tools to and from a magazine via the tool list. When a tool is loaded, it is taken to a magazine location. When it is unloaded, it is removed from the magazine and stored in the tool list.

When you are loading a tool, the application automatically suggests an empty location. You may also directly specify an empty magazine location.

You can unload tools from the magazine that you are not using at present. HMI then automatically saves the tool data in the tool list in the NC memory outside the magazine.

Should you want to use the tool again later, simply load the tool with the tool data into the corresponding magazine location again. Then the same tool data does not have to be entered more than once.

Procedure



1. The tool list is opened.
2. Place the cursor on the tool that you want to load into the magazine (if the tools are sorted according to magazine location number you will find it at the end of the tool list).



3. Press the "Load" softkey.

The "Load to... " window opens.
The "... location" field is pre-assigned with the number of the first empty magazine location.



4. Press the "OK" softkey to load the tool into the suggested location.

- OR -



Enter the location number you require and press the "OK" softkey.

- OR -



Press the "Spindle" softkey.

- . The tool is loaded into the specified magazine location or spindle.

Several magazines

If you have configured several magazines, the "Load to ..." window appears after pressing the "Load" softkey.

If you do not want to use the suggested empty location, then enter your desired magazine and magazine location. Confirm your selection with "OK".

Multiple load points

If you have configured several loading points for a magazine, then the "Load Point Selection" window appears after pressing the "Load" softkey.

Select the required loading point and confirm with "OK".

Unloading tools



1. Place the cursor on the tool that you would like to unload from the magazine and press the "Unload" softkey.

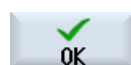

2. Select the required load point in the "Load Point Selection" window.

3. Confirm your selection with "OK".



- OR -

Undo your selection with "Cancel".

13.5.7 Selecting a magazine

You can directly select the buffer memory, the magazine, or the NC memory.

Procedure



1. The tool list is opened.



2. Press the "Magazine selection" softkey.

If there is only one magazine, you will move from one area to the next (i.e. from the buffer memory to the magazine, from the magazine to the NC memory, and from the NC memory back to the buffer memory) each time you press the softkey. The cursor is positioned at the beginning of the magazine each time.

- OR -



If there is more than one magazine, the "Magazine Selection" window opens. Position the cursor on the desired magazine in this window and press the "Go to ..." softkey.

The cursor jumps directly to the beginning of the specified magazine.

Hiding magazines

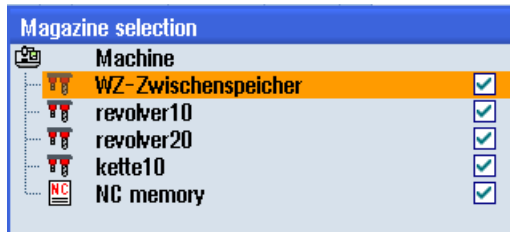

Deactivate the checkbox next to the magazines that you do not want to appear in the magazine list.

The magazine selection behavior with multiple magazines can be configured in different ways.



Machine manufacturer

Please refer to the machine manufacturer's specifications.

References

For a description of configuration options, refer to the Commissioning Manual SINUMERIK Operate (IM9) / SINUMERIK 840D sl

13.5.8 Code carrier connection (only 840D sl)

13.5.8.1 Overview

You have the option of configuring a code carrier connection.

This means that the following functions are available in SINUMERIK Operate:

- Creating a new tool from code carrier
- Unloading tools on code carrier



Software option

In order to use the functions, you require the option "Tool Ident Connection".

References

Further details on tool management with code carrier and the configuration of the user interface in SINUMERIK Operate can be found in the following reference:

- Function Manual SINUMERIK Integrate for Production AMB, AMC AMM/E
- SINUMERIK Operate Commissioning Manual
- SINUMERIK 840D sl Function Manual, Tool Management

With a code carrier connection, in the list of favorites, there is also a tool available.

New tool - favorites		
Type	Identifier	Tool position
	Tool from code carrier	
500	- Roughing tool	
510	- Finishing tool	
520	- Plunge cutter	
540	- Threading tool	
550	- Button tool	
560	- Rotary drill	
580	- 3D turning probe	
730	- Stop	
120	- End mill	
140	- Facing tool	
150	- Side mill	
200	- Twist drill	
240	- Tap	

Figure 13-17 New tool from code carrier in the list of favorites

Creating a new tool from code carrier



1. The tool list is opened.

2. Place the cursor in the tool list at the position where the new tool should be created.

For this, you can select an empty magazine location or the NC tool memory outside of the magazine.

You may also position the cursor on an existing tool in the area of the NC tool memory. Data from the displayed tool will not be overwritten.



3. Press the "New tool" softkey.

The "New Tool - Favorites" window opens.



4. Position the cursor on the entry "Tool from code carrier" and press the "OK" softkey.

The tool data is read from the code carrier, and is displayed in the "New tool" window with the tool type, tool name and possibly with certain parameters.

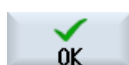

5. Press the "OK" softkey.

The tool is added to the tool list with the specified name. If the cursor is located on an empty magazine location in the tool list, then the tool is loaded to this magazine location.

Unloading tool on code carrier



1. The tool list is opened.



2. Place the cursor on the tool that you would like to unload from the magazine and press the "Unload" and "On code carrier" softkeys.



The tool is unloaded and the data of the tool are then written to the code carrier.

According to the appropriate setting, after being read out on the code carrier, the unloaded tool on the code carrier is deleted from the NC memory.

Delete tool on code carrier



1. The tool list is opened.



2. Position the cursor on the tool on code carrier that you want to delete.



3. Press the "Delete tool" and "On code carrier" softkeys.

The tool is unloaded and the data of the tool are written to the code carrier. The tool is then deleted from the NC memory.

The deletion of the tool can be set differently, i.e. the "On code carrier" softkey is not available.

13.5.9 Managing a tool in a file

If the "Permit tool in/out file" option is activated in the tool list settings, then an additional entry is available in the list of favorites.

New tool - favorites		
Type	Identifier	Tool position
	Tool from file	
500	- Roughing tool	
510	- Finishing tool	
520	- Plunge cutter	
540	- Threading tool	
550	- Button tool	
560	- Rotary drill	
580	- 3D turning probe	
730	- Stop	
120	- End mill	
140	- Facing tool	
150	- Side mill	
200	- Twist drill	
240	- Tap	

Figure 13-18 New tool from file in the list of favorites

Creating a new tool from file



1. The tool list is opened.

2. Place the cursor in the tool list at the position where the new tool should be created.

For this, you can select an empty magazine location or the NC tool memory outside of the magazine.

You may also position the cursor on an existing tool in the area of the NC tool memory. Data from the displayed tool will not be overwritten.



3. Press the "New tool" softkey.

The "New Tool - Favorites" window opens.

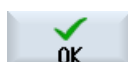

4. Position the cursor on the entry "Tool from file" and press the "OK" softkey. The "Load tool data" window is opened.

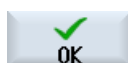

5. Navigate to the required file and press the "OK" softkey.

The tool data is read from the file, and is displayed in the "New tool from file" window with the tool type, tool name and possibly with certain parameters.

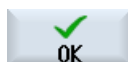

6. Press the "OK" softkey.

The tool is added to the tool list with the specified name. If the cursor is located on an empty magazine location in the tool list, then the tool is loaded to this magazine location.

The tool creation sequence can be defined differently.

Unloading a tool in a file



1. The tool list is opened.



2. Place the cursor on the tool that you would like to unload from the magazine and press the "Unload" and "In file" softkeys.

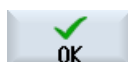

3. Navigate to the required directory and press the "OK" softkey.



4. Enter the required file name in the "Name" field and press the "OK" softkey.

The field is pre-assigned with the tool names.

The tool is unloaded and the data of the tool are written to the file.

According to the corresponding setting, after being read out, the unloaded tool is deleted from the NC memory.

Deleting a tool in a file



1. The tool list is opened.



2. Position the cursor on the tool that you wish to delete.

3. Press the "Delete tool" and "In file" softkeys.



3. Navigate to the required directory and press the "OK" softkey.



4. Enter the required file name in the "Name" field and press the "OK" softkey.

The field is pre-assigned with the tool names.

The tool is unloaded and the data of the tool are written to the file. The tool is then deleted from the NC memory.

13.6 Tool wear

All parameters and functions that are required during operation are contained in the tool wear list.

Tools that are in use for long periods are subject to wear. You can measure this wear and enter it in the tool wear list. The control then takes this information into account when calculating the tool length or radius compensation. This ensures a consistent level of accuracy during workpiece machining.

Monitoring types

You can automatically monitor the tools' working times via the workpiece count, tool life or wear.



Note

Combination of monitoring types

You have the option to monitor a tool by a type or any combination of monitoring types can be switched on.

In addition, you can disable tools when you no longer wish to use them.

Tool parameters

Column heading	Meaning
Location BS   * If activated in magazine selection	Magazine/location number <ul style="list-style-type: none"> The magazine location numbers The magazine number is specified first, followed by the location number in the magazine. If there is only one magazine, only the location number is displayed. Load position in the load magazine The following icons can also be displayed for other magazine types (e.g. for a chain): <ul style="list-style-type: none"> Spindle location as an icon Locations for gripper 1 and gripper 2 (applies only when a spindle with dual gripper is used) as icons
Type	Tool type Depending on the tool type (represented by an icon), certain tool offset data is enabled. The icon identifies the position of the tool; this was selected when the tool was created.
	You have the option of changing the tool position or the tool type using the <Select> key.



Column heading	Meaning
Tool name	The tool is identified by the name and the sister tool number. You can enter the name as text or number. Note: The maximum length of tool names is 31 ASCII characters. The number of characters is reduced for Asian characters or Unicode characters. The following special characters are not permitted: # "
ST	Sister tool number (for replacement tool strategy).
D	Cutting edge number
Δ length X, Δ length Z	Wear for length X or wear for length Z
Δ Radius	Radius wear
T C	Selection of tool monitoring - by tool life (T) - by count (C) - by wear (W) The wear monitoring is configured via a machine data item. Please refer to the machine manufacturer's instructions.
Tool life Workpiece count Wear * *Parameter depends on selection in TC	Tool life Number of workpieces Tool wear
Setpoint	Setpoint for tool life, workpiece count, or wear
Prewarning limit	Specification of the tool life, workpiece count or wear at which a warning is displayed.
G	The tool is disabled when the checkbox is selected.





Further parameters

If you have set up unique cutting edge numbers, these are displayed in the first column.

Column heading	Meaning
D no.	Unique cutting edge number
SN	Cutting edge number
SC	Setup offsets
	Display of the existing setup offsets

Icons in the tool wear list

Icon/ Marking		Meaning
Tool type		
Red "X"		The tool is disabled.
Yellow triangle pointing downward		The prewarning limit has been reached.

Icon/ Marking		Meaning
Yellow triangle pointing upward		The tool is in a special state. Place the cursor on the marked tool. A tooltip provides a short description.
Green border		The tool is preselected.
Magazine/location number		
Green double arrow		The magazine location is positioned at the change position.
Gray double arrow (configurable)		The magazine location is positioned at the loading position.
Red "X"		The magazine location is disabled.

Procedure



1. Select the "Parameter" operating area.



2. Press the "Tool wear" softkey.

See also

Displaying tool details (Page 743)

Changing the cutting edge position or tool type (Page 752)

13.6.1 Reactivate tool

You can replace disabled tools or make them ready for use again.

Preconditions

In order to be able to reactivate a tool, the monitoring function must be activated and a setpoint must be stored.

Procedure



1. The tool wear list is opened.

2. Position the cursor on the disabled tool which you would like to reuse.



3. Press the "Reactivate" softkey.

The value entered as the setpoint is entered as the new tool life or work-piece count.

The disabling of the tool is cancelled.

Reactivating and positioning

When the "Reactivate with positioning" function is configured, the selected tool's magazine location will also be positioned at a loading point. You can exchange the tool.

Reactivation of all monitoring types

When the "Reactivation of all monitoring types" function is configured, all the monitoring types set in the NC for a tool are reset during reactivation.



Machine manufacturer

Please refer to the machine manufacturer's specifications.

References

Commissioning Manual SINUMERIK Operate (IM9) / SINUMERIK 840D sl

Multiple load points

If you have configured several loading points for a magazine, then the "Load Point Selection" window appears after pressing the "Load" softkey.

Select the required load point and confirm with the "OK" softkey.

13.7 Tool data OEM

You have the option of configuring the list according to your requirements.

References

Refer to the following document for more information on configuring OEM tool data:
Commissioning Manual SINUMERIK Operate (IM9) / SINUMERIK 840D sl

Procedure

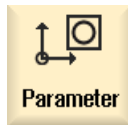

1. Select the "Parameter" operating area.





2. Press the "OEM tool" softkey.

13.8 Magazine

Tools are displayed with their magazine-related data in the magazine list. Here, you can take specific actions relating to the magazines and the magazine locations.

Individual magazine locations can be location-coded or disabled for existing tools.

Tool parameters







Column heading	Meaning
Location BS   * If activated in magazine selection	Magazine/location number <ul style="list-style-type: none"> The magazine location numbers The magazine number is specified first, followed by the location number in the magazine. If there is only one magazine, only the location number is displayed. Load position in the load magazine The following icons can also be displayed for other magazine types (e.g. for a chain): <ul style="list-style-type: none"> Spindle location as an icon Locations for gripper 1 and gripper 2 (applies only when a spindle with dual gripper is used) as icons
Type	Tool type Depending on the tool type (represented by an icon), certain tool offset data is enabled. The icon identifies the position of the tool; this was selected when the tool was created.
	You have the option of changing the tool position or the tool type using the <Select> key.
Tool name	The tool is identified by the name and number of the replacement tool (ST). You can enter the name as text or number. Note: The maximum length of tool names is 31 ASCII characters. The number of characters is reduced for Asian characters or Unicode characters. The following special characters are not permitted: # ".
ST	Number of the replacement tool.
D	Cutting edge number
G	Disabling of the magazine location.
Mag.loc. type	Display of magazine location type.
Tool.loc. type	Display of tool location type.
Ü	Marking a tool as oversized. The tool occupies two half locations left, two half locations right, one half location top and one half location bottom in a magazine.
P	Fixed location coding. The tool is permanently assigned to this magazine location.

Further parameters

If you have set up unique cutting edge numbers, these are displayed in the first column.

Column heading	Meaning
D no.	Unique cutting edge number
SN	Cutting edge number

Magazine list icons

Icon/ Marking		Meaning
Tool type		
Red "X"		The tool is disabled.
Yellow triangle pointing downward		The prewarning limit has been reached.
Yellow triangle pointing upward		The tool is in a special state. Place the cursor on the marked tool. A tooltip provides a short description.
Green border		The tool is preselected.
Magazine/location number		
Green double arrow		The magazine location is positioned at the change position.
Gray double arrow (configurable)		The magazine location is positioned at the loading position.
Red "X"		The magazine location is disabled.

Procedure



1. Select the "Parameter" operating area.



2. Press the "Magazine" softkey.

See also

Displaying tool details (Page 743)

Changing the cutting edge position or tool type (Page 752)

13.8.1 Positioning a magazine

You can position magazine locations directly on the loading point.

Procedure



1. The magazine list is opened.
2. Place the cursor on the magazine location that you want to position onto the load point.



3. Press the "Position magazine" softkey.
The magazine location is positioned on the loading point.

Multiple load points

If you have configured several loading points for a magazine, then the "Load Point Selection" window appears after pressing the "Position magazine" softkey.

Select the desired loading point in this window and confirm your selection with "OK" to position the magazine location at the loading point.

13.8.2 Relocating a tool

Tools can be directly relocated within magazines to another magazine location, which means that you do not have to unload tools from the magazine in order to load them into a different location.

When you are relocating a tool, the application automatically suggests an empty location. You may also directly specify an empty magazine location.



Machine manufacturer

Please refer to the machine manufacturer's specifications.

Procedure



1. The magazine list is opened.
2. Position the cursor on the tool that you wish to relocate to a different magazine location.



3. Press the "Relocate" softkey.
The "... relocate from location ... to location ..." window is displayed. The "Location" field is pre-assigned with the number of the first empty magazine location.



4. Press the "OK" softkey to relocate the tool to the recommended magazine location.

- OR -

Enter the required magazine number in the "...magazine" field and the required magazine location number in "Location" field.



Press the "OK" softkey.

The tool is relocated to the specified magazine location.

Several magazines

If you have set up several magazines, then the "...relocate from magazine... location... to..." window appears after pressing the "Relocate" softkey.

Select the desired magazine and location, and confirm your selection with "OK" to load the tool.

13.8.3 Delete/unload/load/relocate all tools

You have the option of deleting all tools from the magazine list, unloading all tools from the magazine list, loading all tools to the magazine, or relocating tools simultaneously.

Preconditions

The following requirements must be met so that the "Delete all," "Unload all," "Load all," or "Relocate all" softkey is displayed and is available:

- Magazine management is set up
- There is no tool in the buffer / in the spindle



Machine manufacturer

Please observe the information provided by the machine manufacturer.

Procedure



1. The magazine list is opened.



2. Press the "Delete all" softkey.

- OR -



Press the "Unload all" softkey.

- OR -



Press the "Load all" softkey.



- OR -

Press the "Unload all" softkey.

A prompt is displayed as to whether you really want to unload, load or relocate all tools.

3. Press the "OK" softkey to go ahead and delete, unload, load, or relocate the tools.

The tools are deleted from the magazine, unloaded from the magazine, loaded into the magazine, or relocated in ascending order of magazine location numbers.

4. Press the "Cancel" softkey if you wish to cancel the unloading operation.

13.9 Tool details

13.9.1 Displaying tool details

The following parameters of the selected tool can be displayed using softkeys in the "Tool Details" window.

- Tool data
- Cutting edge data
- Monitoring data

Procedure



1. The tool list, the wear list, the OEM tool list or the magazine is open.

...



2. Position the cursor to the desired tool.



3. If you are in the tool list or in the magazine, press the ">>" and "Details" softkeys.



- OR -



If you are in the wear list or OEM tool list, press the "Details" softkey.



The "Tool Details" window opens.

All of the available tool data are displayed.





4. Press the "Cutting edge data" softkey if you wish to display the cutting edge data.



5. Press the "Monitoring data" softkey if you want to display the monitoring data.

13.9.2 Tool data







The "Tool Details" window provides the following data on the selected tool when the "Tool data" softkey is active.

Parameter	Meaning		
Magazine location	The magazine number is specified first, followed by the location number in the magazine. If there is only one magazine, only the location number is displayed.		
Tool name	The tool is identified by the name and the sister tool number. You can enter the name as text or number.		
ST	Sister tool number (for sister tool strategy)		
D quantity	Number of created cutting edges		
D	Cutting edge number		
Tool state	A	Activate tool	
	F	Tool enabled	
		G	Block tool
		M	Measure tool
		V	Reaching the prewarning limit
	W	Tool being changed	
	P	Tool in fixed location The tool is permanently assigned to this magazine location	
	I	Tool has been in use	
Tool size	Standard	Tool does not require an additional location in a magazine.	
			
	Oversize	The tool occupies two half locations left, two half locations right, one half location top and one half location bottom in a magazine.	
	Special size		
		Left	Number of half locations to the left of the tool
	Right	Number of half locations to the right of the tool	
Tool OEM parameters 1 - 6	Freely available pa- rameters		

13.9.3 Cutting edge data

The "Tool Details" window provides the following data on the selected tool when the "Cutting edge data" softkey is active.

Parameter	Meaning
Magazine location	The magazine number is specified first, followed by the location number in the magazine. If there is only one magazine, only the location number is displayed.
Tool name	The tool is identified by the name and the sister tool number. You can enter the name as text or number.
ST	Sister tool number (for replacement tool strategy)
D quantity	Number of created cutting edges
D	Cutting edge number
Tool type	Tool symbol with type number and current cutting edge position

Parameter	Meaning	
	Length X	Length Z
Geometry	Geometry data, length X	Geometry data, length Z
Wear	Length X wear	Length Y wear
	Radius	
Geometry	Tool radius	
Wear	Radius wear	
For type 500 (rougher) and type 510 (finisher)		
		The cutting edge graphic shows the positioning defined by the holder angle, cut direction and cutting tip angle.
Cutting edge graphic		
Reference direction		The reference direction for the holder angle specifies the cut direction.
Holder angle	To determine the cutting edge positioning	
Cutting tip angle	To determine the cutting edge positioning	
Type 240 - tap		
Pitch		
Type 200 - twist drill, type 220 - centering tool and type 230 - countersink		
Tip angle		
Type 520 -plunge cutter, type 530 - parting tool, type 540 - threading tool		
Cutting tip length	For displaying the tools during the simulation of the program execution	
Cutting tip width	Width of the plunge cutter	
Type 110 - ball end mill for cylindrical die-sinking cutter, type 111 - ball end mill for tapered die-sinking cutter, type 120 - end mill, type 121 - end mill with corner rounding, type 130 - angle head cutter, type 140 - facing tool, type 150 - side mill, type 155 - bevel cutter, type 156 - bevel cutter with corner rounding and type 157 - tapered die-sinking cutter		
N	Number of teeth	
For driven tools (drills and milling tools)		
Direction of spindle rotation		Spindle is not switched on
		CW spindle rotation
		CCW spindle rotation
		
	Coolant 1 and 2 (e.g. internal and external cooling) can be switched on and off. Please refer to the machine manufacturer's specifications.	
Cutting edge OEM parameters 1 - 2		



Software option

In order to be able to manage the parameters spindle direction of rotation, coolant and tool-specific functions (M1-M4), you require the "ShopMill/Shop-Turn" option.

13.9.4 Monitoring data

The "Tool Details" window provides the following data on the selected tool when the "Monitoring data" softkey is active.

Parameter	Meaning
Magazine location	The magazine number is specified first, followed by the location number in the magazine. If there is only one magazine, only the location number is displayed.
Tool name	The tool is identified by the name and the sister tool number. You can enter the name as text or number.
ST	Sister tool number (for sister tool strategy)
D quantity	Number of created cutting edges
D	Cutting edge number
Monitoring type	T - tool life C - count W - wear The wear monitoring is configured via machine data. Please note the specifications of the machine manufacturer.
	Actual value
Tool life, count and wear	Actual value for tool life, count or wear
	Setpoint
Tool life, count and wear	Setpoint for tool life, count or wear
	Prewarning limit
Tool life, count and wear	Specification of the tool life, the count or wear at which a warning is displayed.
Monitoring OEM parameters 1 - 8	

13.10 Sorting tool management lists

When you are working with many tools, with large magazines or several magazines, it is useful to display the tools sorted according to different criteria. Then you will be able to find a specific tool more easily in the lists.

Procedure

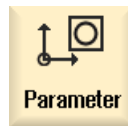

1. Select the "Parameter" operating area.



2. Press the "Tool list", "Tool wear" or "Magazine" softkey.

...



3. Press the ">>" and "Sort" softkeys.



The lists are displayed sorted numerically according to magazine location.



4. Press the "Acc. to type" softkey to display the tools arranged by tool type. Identical types are sorted according to their radius.



Press the "Acc. to name" softkey to display the tool names in alphabetical order.

The replacement tool numbers are used to sort tools with the same names.

- OR -



Press the "Acc. to T number" softkey to display the tools sorted numerically.

The list is sorted according to the specified criteria.



Machine manufacturer

Please refer to the machine manufacturer's specifications.

13.11 Filtering the tool management lists

The filter function allows you to filter-out tools with specific properties in the tool management lists.

For instance, you have the option of displaying tools during machining that have already reached the prewarning limit in order to prepare the corresponding tools for equipping.

Filter criteria

- Only display the first cutting edge
- Only tools that are ready to use
- Only tools with active code
- Only tools that have reached the prewarning limit
- Only locked tools
- Only tools with remaining quantity of ... to ...
- Only tools with residual tool life of ... to ...
- Only tools with unloading marking
- Only tools with loading marking

Note

Multiple selection

You have the option of selecting several criteria. You will receive an appropriate message if conflicting filter options are selected.

You can configure OR logic operations for the various filter criteria.



Machine manufacturer

Please refer to the machine manufacturer's specifications.

References

A description of the configuration options is provided in
SINUMERIK Operate (IM9) / SINUMERIK 840D sl Commissioning Manual

Procedure

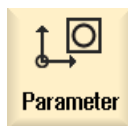

1. Select the "Parameter" operating area.



2. Press the "Tool list", "Tool wear" or "Magazine" softkey.

...



3. Press the ">>" and "Filter" softkeys.
The "Filter" window opens.

...

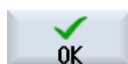

4. Activate the required filter criterion and press the "OK" softkey.
The tools that correspond to the selection criteria are displayed in the list.
The active filter is displayed in the window header.

13.12 Specific search in the tool management lists

There is a search function in all tool management lists, where you can search for the following objects:

- **Tools**
 - You enter a tool name. You can narrow down your search by entering a replacement tool number.
You have the option of only entering a part of the name as search term.
 - You enter the D number and activate if necessary, the check box "Active D number".
- **Magazine locations or magazines**

If only one magazine is configured, then the search is made according to the magazine location.

If several magazines are configured, then it is possible to search a specific magazine location in a specific magazine or just to search in a specific magazine.
- **Empty locations**

The empty location search is realized using the tool size. The tool size is defined by the number of half locations required to the right, left, top and bottom. All four directions are of significance for a box magazine. For a chain magazine, a disk-type or a turret, only the half locations to the right and left are of significance. The maximum number of half locations, which a tool can occupy is limited to 7.

If the lists with the location type are used, then the empty location search is made using the location type and location size.

You can enter the location type as numerical value or as text depending on the particular configuration.



Machine manufacturer

Please refer to the machine manufacturer's specifications.

References

For a description of configuration options, refer to the
Commissioning Manual SINUMERIK Operate (IM9) / SINUMERIK 840D sl

Procedure











1. Select the "Parameter" operating area.



2. Press the "Tool list", "Tool wear" or "Magazine" softkey.

...



- 
3. Press the ">>" and "Search" softkeys.
- 
- Search**
- 
- Tool**
4. Press the "Tool" softkey if you wish to search for a specific tool.
- OR -
- 
- Magazine location**
- Press the "Magazine location" softkey if you wish to search for a specific magazine location or a specific magazine.
- OR -
- 
- Empty location**
- Press the "Empty location" softkey if you wish to search for a specific empty location.
- 
- OK**
5. Press the "OK" softkey.
The search is started.
- 
- Search**
6. Press the "Search" softkey again if the tool that was found is not the tool that was being searched for.
The search term is kept and with "OK" you start the search for the next tool that corresponds to the entry.
- 
- Cancel**
7. Press the "Cancel" softkey to cancel the search.

13.13 Changing the cutting edge position or tool type

Procedure



1. The tool list, the wear list, the OEM tool list or the magazine is opened.

...



2. Position the cursor in the column "Type" of the tool that you wish to change.



3. Press the <SELECT> key.
The "Tool types - Favorites" window opens.



4. Press the <Cursor right> or <Cursor left> key to select the new cutting edge position.



- OR -

Select the required tool type in the list of favorites or select using softkeys "Cutters 100-199", "Drills 200-299", "Cutting tools 500-599" or "Special tools 700-900".



5. Press the "OK" softkey.
The new cutting edge position or the new tool type is accepted and the corresponding icon is displayed in the "Type" column.

13.14 Settings for tool lists

In the "Settings" window you have the following options to set the view in the tool lists:

- Display only one magazine in "Magazine sort"
 - You can limit the display to one magazine. The magazine is displayed with the assigned buffer magazine locations and the tools not loaded.
 - You may set via a configuration if you want to jump to the next magazine by clicking softkey "Magazine selection" or if the dialog "Magazine selection" is switched over to any magazine.
- Display only spindle in buffer.
In order to display only the spindle location during operation, the remaining locations of the buffer are hidden.
- Permitting tool in/out file
 - When creating a new tool, the tool data can be loaded from a file.
 - When deleting or unloading a tool, the tool data can be backed up to a file.
- Switch on adapter-transformed view
 - Geometry lengths and the application offsets are displayed in a transformed manner in the tool list.
 - In the tool wear list, the wear length and the sum offsets are displayed in a transformed manner.



Machine manufacturer

Please refer to the machine manufacturer's specifications.

References

For further information about configuring the settings, please refer to the following references:
SINUMERIK Operate (IM9) / SINUMERIK 840D sl Commissioning Manual

Procedure



1. Select the "Parameter" operating area.



2. Press the "Tool list", "Tool wear" or "Magazine" softkey.

...



13.14 Settings for tool lists



3. Press the "Continue" and "Settings" softkeys.



4. Activate the corresponding check box for the desired setting.

13.15 Working with multitool

Using a multitool you have the possibility of storing more than one tool at a magazine location. The multitool itself has two or more locations to accept tools. The tools are directly mounted on the multitool. The multitool is located at a location in the magazine.

Typical applications

One application for using multitools on lathes with revolver and counterspindle is to equip the multitool with two turning tools. One turning tool for machining on the main spindle and one turning tool for machining on the counterspindle.

An additional application is to use multitools on lathes equipped with a tool spindle. A multitool, on which several tools have been mounted, is inserted in the tool spindle at this machine. A tool change within the multitool is realized by positioning the multitool, i.e. by rotating the tool spindle.

Geometrical arrangement of the tools on the multitool

The geometrical arrangement of the tools is defined by the clearance between the locations on the multitool.

The clearance between the locations can be defined as follows:

- Using the multitool location number or
- using the angle of the multitool location

If angle is selected here, then the value of the angle must be entered for each multitool location.

Regarding loading and unloading in a magazine, the multitool is treated as a single unit.

13.15.1 Tool list for multitool

If you work with a multitool, the tool list is supplemented by the column for the multitool location number. As soon as the cursor is at a multitool in the tool list, certain column headings change.

Column heading	Meaning
Location	Magazine/location number
MT loc.	Multitool location number
TYPE	Symbol for multitool
Multitool name	Name of the multitool

TOA 1		Tool list						Chain_1_120	
Loc.	MT LO.	Type	Multitool name						
1/105			MULTITool45						
	1		SCHRUPPER_HS	1	1	25.462	29.469	0.500 ←	95.0 80
	2		SCHRUPPER_GS	1	1	34.056	110.453	0.500 →	95.0 80
1/106									
1/107									

Figure 13-19 Toll list with multitool in the spindle

Procedure

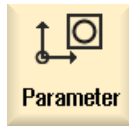

1. Select the "Parameter" operating area.



2. Press the "Tool list" softkey.
The "Tool List" window opens.

13.15.2 Create multitool

The multitool can be selected in the list of favorites as well as in the list of special tool types.

New tool - favorites		
Type	Identifier	Tool position
500	- Roughing tool	
510	- Finishing tool	
520	- Plunge cutter	
540	- Threading tool	
550	- Button tool	
560	- Rotary drill	
580	- 3D turning probe	
730	- Stop	
120	- End mill	
140	- Facing tool	
150	- Side mill	
200	- Twist drill	
240	- Tap	
	Multitool	

Figure 13-20 List of favorites with multitool









New tool - special tools		
Type	Identifier	Tool position
700	- Slotting saw	
710	- 3D probe	
711	- Edge finder	
712	- Mono probe	
713	- L probe	
714	- Star probe	
725	- Calibrating tool	
730	- Stop	
731	- Mandrel	
732	- Steady rest	
	Multitool	

Figure 13-21 Selection list for special tools with multitool

Procedure

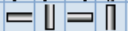

1. The tool list is opened.

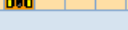
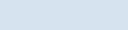
2. Position the cursor at the position where the tool is to be created. For this, you can select an empty magazine location or the NC tool memory outside of the magazine. You may also position the cursor on an existing tool in the area of the NC tool memory. Data from the displayed tool will not be overwritten.



3. Press the "New tool" softkey.

The "New Tool - Favorites" window opens.

- OR -



Press the softkey "Special tool 700-900".

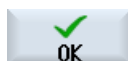

4. Select the multitool and press the "OK" softkey.

The "New Tool" window appears.



5. Enter the multitool name and define the number of multitool locations.

If you wish to define the clearance of the tools based on the angle, activate the "Angle input" checkbox, and for each multitool location, enter the clearance to the reference location as angular value.

New tool									
Multitool name	No. of locs.	Angle input	Multitool angle						
MULTITOOL3	3	<input checked="" type="checkbox"/>	<table border="1"> <tr> <td>1</td> <td>0.000</td> </tr> <tr> <td>2</td> <td>120.000</td> </tr> <tr> <td>3</td> <td>230.000</td> </tr> </table>	1	0.000	2	120.000	3	230.000
1	0.000								
2	120.000								
3	230.000								

The multitool is created in the tool list.

Note

The tool creation sequence can be defined differently.



Machine manufacturer

Please refer to the machine manufacturer's specifications.

13.15.3 Equipping multitool with tools

Precondition

A multitool has been created in the tool list.

Procedure



1. The tool list is opened.

Equip the multitool with tools



2. Select the required multitool, position the cursor on an empty multitool location.



3. Press the "New tool" softkey.

4. Using the appropriate selection list, e.g. favorites, select the required tool.

Load multitool



2. Select the required multitool, position the cursor on an empty multitool location.



3. Press the "Load" softkey.
The "Load with..." window opens.



4. Select the required tool.

Load the tool into the multitool



2. Position the cursor on the tool that you want to load into the multitool.
3. Press the "Load" and "Multitool" softkeys. The "Load to..." window opens.

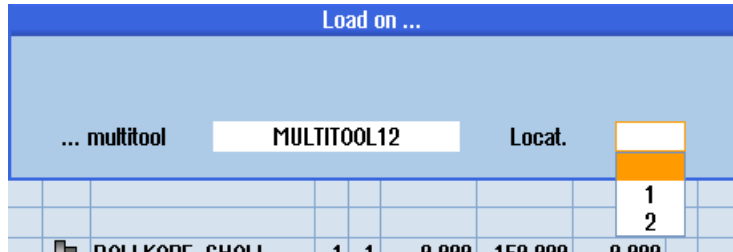

4. Select the required multitool and the multitool location to which you wish to load the tool.

13.15.4 Removing a tool from multitool

If the multitool was mechanically re-assigned (i.e. new tool were mounted), then old tools in the tool list must be removed from the multitool.

To do this, the cursor is positioned at the line where the tool is located, which is to be removed. When unloading, the tool is automatically saved in the tool list outside the magazine in the NC memory.

Procedure



1. The tool list is opened.
2. Position the cursor on the tool that you would like to unload from the multitool and press the "Unload" softkey.
- OR -
Position the cursor on the tool that you would like to remove and delete from the multitool and press the "delete tool" softkey.

13.15.5 Delete multitool

Procedure



1. The tool list is opened.
2. Position the cursor on the multitool that you wish to delete.
3. Press the "Delete multitool" softkey.
The multitool with all of the tools that are located in it is deleted.



13.15.6 Loading and unloading multitool

Procedure



1. The tool list is opened.

Load a multitool into the magazine



2. Position the cursor at the multitool that you wish to load into the magazine.
3. Press the "Load" softkey.
The "Load to" window opens.
The field "... Locat." is initialized with the number of the first empty magazine location.
4. Press the "OK" softkey to load the multitool to the recommended empty location.

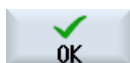

- OR -

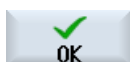

Enter the location number you require and press the "OK" softkey.
The multitool together with the tools in it is loaded to the specified magazine location.

Loading a multitool into a magazine



2. Position the cursor on the required empty magazine location.
3. Press the "Load" softkey.
The "Load with." window opens.
4. Select the required multitool.
5. Press the "OK" softkey.



Unloading a multitool



2. Position the cursor on the multitool that you wish to unload from the magazine.
3. Press the "Unload" softkey.
The multitool is removed from the magazine and is saved in the NC memory at the end of the tool list.

13.15.7 Reactivating the multitool

Multitool and tools located on the multitool can be disabled independently of one another.

If a multitool is disabled, then the tools of the multitool can no longer be changed in using a tool change.

If only one tool on a multitool has a set monitoring function and the lifetime or the unit quantity has expired, then the tool and the multitool on which the tool is located are disabled. The other tools on the multitool are not disabled.



Machine manufacturer

Please refer to the machine manufacturer's specifications.

If several tools with monitoring are mounted on the multitool and the lifetime or unit quantity has expired for one tool, then only this tool is disabled.

TOA 1		Tool wear										Chain_1_120	
Loc.	MT LO.	Type	Tool name	ST	D	gth	ΔRadius	T C	Tool life	Set val	Prewar limit	D	
1/105			MULTITool45									<input checked="" type="checkbox"/>	
	1		SCHRUPPER_HS	1	1	000	0.000	T	32.0	100.0	10.0	<input type="checkbox"/>	
	2		SCHRUPPER_GS	1	1	000	0.000	T	0.0	100.0	10.0	<input checked="" type="checkbox"/>	
1/106													
1/107													

Reactivating

If a tool with expired lifetime or unit quantity that is mounted on a multitool is reactivated, then for this tool, the lifetime/unit quantity is set to the setpoint and the tool and the multitool are re-enabled (disable status is removed).

If a multitool is reactivated, on which tools with monitoring are mounted, then the lifetime/unit quantity for all tools on the multitool are set to the setpoint no matter whether the tools are disabled or not.

Requirements

In order to reactivate a tool, the monitoring function must be activated and a setpoint must be stored.

Procedure

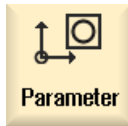

1. Select the "Parameter" operating area.



2. Press the "Tool wear" softkey.

3. Position the cursor at the multitool that is disabled and which you would like to reactivate.

- OR -

Position the cursor on the tool that you would like to reactivate again.



4. Press the "Reactivate" softkey.

The value entered as the setpoint is entered as the new tool life or workpiece count.

The tool and the multitool are then no longer disabled (the disable is withdrawn).

Reactivating and positioning

When the "Reactivate with positioning" function is configured, then also the magazine location at which the selected multitool is located, is positioned to the loading point. You can exchange the multitool.

Reactivation of all monitoring types

When the "Reactivation of all monitoring types" function is configured, all the monitoring types set in the NC for a tool are reset during reactivation.



Machine manufacturer

Please refer to the machine manufacturer's specifications.

References

Commissioning Manual SINUMERIK Operate (IM9) / SINUMERIK 840D sl

13.15.8 Relocating a multitool

Multitools can be directly relocated within magazines to another magazine location, which means that you do not have to unload multitools with the associated tools from the magazine in order to relocate them to a different location.

When you are relocating a multitool, the system automatically recommends an empty location. You may also directly specify an empty magazine location.

Procedure

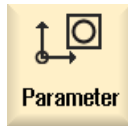

1. Select the "Parameter" operating area.



2. Press the "Magazine" softkey.

3. Position the cursor at the multitool that you wish to relocate to a different magazine location.



4. Press the "Relocate" softkey.

The "... relocate from location ... to location ..." window is displayed. The "Location" field is pre-assigned with the number of the first empty magazine location.



5. Press the "OK" softkey to relocate the multitool to the recommended magazine location.

- OR -

Enter the required magazine number in the "...magazine" field and the required magazine location number in "Location" field.

Note:

Please refer to the machine manufacturer's specifications.

Press the "OK" softkey.

The multitool with the tools is relocated to the specified magazine location.

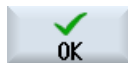

13.15.9 Positioning multitool

You can position a magazine. In this case, a magazine location is positioned to the loading point.

Multitools, which are located in a spindle, can also be positioned. The multitool is rotated and therefore the multitool location involved is brought into the machining position.

Procedure



1. The magazine list is opened.
The multitool is in the spindle.

2. Position the cursor on the multitool location that you want to bring into the machining position.



3. Press the "Position multitool" softkey.

Managing programs

14.1 Overview

You can access programs at any time via the Program Manager for execution, editing, copying, or renaming.

Programs that you no longer require can be deleted to release their storage space.

NOTICE

Execution from USB-FlashDrive

Direct execution from a USB-FlashDrive is not recommended.

There is no protection against contact problems, falling out, breakage through knocking or unintentional removal of the USB-FlashDrive during operation.

Disconnecting it during operation will result in the stopping of the machining and thus to the workpiece being damaged.

Storage for programs

Possible storage locations are:

- NC
- Local drive
- Network drives
- USB drives
- FTP drives
- V24



Software options

To display the "Local drive" softkey, you require option "Additional HMI user memory on CF card of the NCU" (not for SINUMERIK Operate on PCU50 or PC/PG).

Data exchange with other workstations

You have the following options for exchanging programs and data with other workstations:

- USB drives (e.g. USB-FlashDrive)
- Network drives
- FTP drive

Choosing storage locations

In the horizontal softkey bar, you can select the storage location that contains the directories and programs that you want to display. In addition to the "NC" softkey, via which the file system data can be displayed, additional softkeys can be displayed.

The "USB" softkey is only operational when an external storage medium is connected (e.g. USB-FlashDrive on the USB port of the operator panel).

Displaying documents

You can display documents on all drives of the program manager (e.g. in the local drive or USB) and via the data tree of the system data. Various data formats are supported:

- PDF
- HTML
It is not possible to preview HTML documents.
- Various graphic formats (e.g. BMP or JPEG)
- DXF



Software options

You require the "DXF reader" option in order to display DXF files.

Note

FTP drive

It is not possible to preview documents on the FTP.

Structure of the directories

In the overview, the symbols in the left-hand column have the following meaning:



Directory



Program

All directories have a plus sign when the program manager is called for the first time.

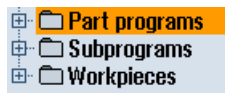

Figure 14-1 Program directory in the program manager

The plus sign in front of empty directories is removed after they have been read for the first time.

The directories and programs are always listed complete with the following information:

- Name
The name length is 24 characters.
Permissible characters include all upper-case letters (without accents), numbers, and underscores.
- Type
Directory: WPD
Program: MPF
Subprogram: SPF
Initialization programs: INI
Job lists: JOB
Tool data: TOA
Magazine assignment: TMA
Zero points: UFR
R parameters: RPA
Global user data/definitions: GUD
Setting data: SEA
Protection zones: PRO
Sag: CEC
- Size (in bytes)
- Date/time (of creation or last change)

Active programs

Selected, i.e. active programs are identified by a green symbol.

CHAN1	Name	Type	Length	Date	Time
+	Part programs	DIR		11/30/09	3:49:09 PM
+	Subprograms	DIR		12/02/09	11:24:33 AM
+	Workpieces	DIR		12/02/09	2:53:07 PM
+	DREHEN1	WPD		12/02/09	8:40:58 AM
+	GGG	WPD		12/01/09	12:03:39 PM
+	JOBSHOP_MEHRK	WPD		12/03/09	9:18:27 AM
+	MEHR	WPD		11/30/09	3:49:23 PM
+	MEHRKANAL	WPD		12/02/09	12:47:20 PM
+	SIM_CHESS_KING	WPD		11/30/09	3:49:14 PM
+	SIM_CHESS_LADY_26	WPD		11/30/09	3:49:14 PM
+	SIM_CHESS_TOWER	WPD		11/30/09	3:49:15 PM
+	SIM_ZYK_T_26	WPD		11/30/09	3:49:17 PM
+	SWJOB	WPD		12/03/09	8:39:49 AM
+	UT	MPF	205	12/03/09	3:22:48 PM
+	TEMP	WPD		11/30/09	3:49:33 PM

Figure 14-2 Active program shown in green

14.1.1 NC memory

The complete NC working memory is displayed along with all tools and the main programs and subroutines.

You can create further subdirectories here.

Procedure



1. Select the "Program Manager" operating area.



2. Press the "NC" softkey.

14.1.2 Local drive

Workpieces, main and subprograms that are saved in the user memory of the CF card or on the local hard disk are displayed.

For archiving, you have the option of mapping the structure of the NC memory system or to create a separate archiving system.

You can create any number of subdirectories here, in which you can store any files (e.g. text files with notes).



Software options

To display the "Local drive" softkey, you require option "Additional HMI user memory on CF card of the NCU" (not for SINUMERIK Operate on PCU50 or PC/PG).

Procedure



1. Select the "Program manager" operating area.



2. Press the "Local drive" softkey.

On the local drive, you have the option of mapping the directory structure of the NC memory. This also simplifies the search sequence.

Creating Directories



1. The local drive is selected.



2. Position the cursor on the main directory.



3. Press the "New" and "Directory" softkeys. The "New Directory" window opens.



4. In the "Name" entry field, enter "mpf.dir", "spf.dir" and "wks.dir" and press the "OK" softkey.

The directories "Part programs", "Subprograms" and "Workpieces" are created below the main directory.

14.1.3 USB drives

USB drives enable you to exchange data. For example, you can copy to the NC and execute programs that were created externally.

NOTICE

Interruption of operation

Direct execution from the USB FlashDrive is not recommended, because machining can be undesirably interrupted, therefore resulting in workpiece damage.

Partitioned USB-FlashDrive (only 840D sl and TCU)

If the USB-FlashDrive has several partitions, these are displayed in a tree structure as a subtree (01,02,...).

For EXTCALL calls, enter the partition (e.g. USB:/02/... or //ACTTCU/FRONT/02/... or //ACTTCU/FRONT,2/... or //TCU/TCU1/FRONT/02/...)

You can also configure any partition (e.g. //ACTTCU/FRONT,3).

Procedure



1. Select the "Program manager" operating area.



2. Press the "USB" softkey.

Note

The "USB" softkey can only be operated when a USB-FlashDrive is inserted in the front interface of the operator panel.

14.1.4 FTP drive

The FTP drive offers you the following options - to transfer data, e.g. part programs, between your control system and an external FTP server.

You have the option of archiving any files in the FTP server by creating new directories and subdirectories.

Note

Selecting a program / execution

It is not possible to select a program directly on the FTP drive, and change to execution in the "Machine" operating area.

Precondition

User name and password have been set up in the FTP server.

Procedure



1. Select the "Program manager" operating area.



2. Press the "FTP" softkey.
When selecting the FTP drive for the first time, a login window is displayed.



3. Enter the user name and password and press the "OK" softkey to log into the FTP server.

The content of the FTP server with its folders is displayed.



4. Press the "Log out" softkey after the required data processing has been completed.

The connection to the FTP server is disconnected. In order to reselect the FTP drive, you must log on again.

14.2 Opening and closing the program

To view a program in more detail or modify it, open the program in the editor.

With programs that are in the NCK memory, navigation is already possible when opening. The program blocks can only be edited when the program has been opened completely. You can follow the opening of the program in the dialog line.

With programs that are opened via local network, USB FlashDrive or network connections, navigation is only possible when the program has been opened completely. A progress message box is displayed when opening the program.

Note

Channel changeover in the editor

When opening the program, the editor is opened for the currently selected channel. This channel is used to simulate the program.

If you change over a channel in the editor, this does not influence the editor. Only when closing the editor do you change into the other channel.

Procedure



1. Select the "Program manager" operating area.



2. Select the desired storage location and position the cursor on the program that you would like to edit.

3. Press the "Open" softkey.

- OR -



Press the <INPUT> key.

- OR -



Press the <Cursor right> key.

- OR -

Double-click the program.

The selected program is opened in the "Editor" operating area.

4. Now make the necessary program changes.



5. Press the "NC Select" softkey to switch to the "Machine" operating area and begin execution.



When the program is running, the softkey is deactivated.

Closing the program



Press the ">>" and "Exit" softkeys to close the program and editor again.



- OR -



If you are at the start of the first line of the program, press the <Cursor left> key to close the program and the editor.



To reopen a program you have exited with "Close", press the "Program" key.

Note

A program does not have to be closed in order for it to be executed.

14.3 Executing a program

When you select a program for execution, the control switches automatically to the "Machine" operating area.

Program selection

Select the workpieces (WPD), main programs (MPF) or subprograms (SPF) by placing the cursor on the desired program or workpiece.

For workpieces, the workpiece directory must contain a program with the same name. This program is automatically selected for execution (e.g. when you select the workpiece SHAFT.WPD, the main program SHAFT.MPF is automatically selected).

If an INI file of the same name exists (e.g. SHAFT.INI), it will be executed once at the first part program start after selection of the part program. Any additional INI files are executed in accordance with machine data MD11280 \$MN_WPD_INI_MODE.

MD11280 \$MN_WPD_INI_MODE=0:

The INI file with the same name as the selected workpiece is executed. For example, when you select SHAFT1.MPF, the SHAFT1.INI file is executed upon <CYCLE START>.

MD11280 \$MN_WPD_INI_MODE=1:

All files of type SEA, GUD, RPA, UFR, PRO, TOA, TMA and CEC which have the same name as the selected main program are executed in the specified sequence. The main programs stored in a workpiece directory can be selected and processed by several channels.



Machine manufacturer

Please refer to the machine manufacturer's specifications.

Procedure



1. Select the "Program manager" operating area.



2. Select the desired storage location, and position the cursor on the workpiece/program that you would like to execute.
3. Press the "Select" softkey.

The control switches automatically into the "Machine" operating area.

- OR -

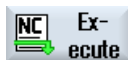

If the selected program is already opened in the "Program" operating area, press the "Execute NC" softkey.



Press the <CYCLE START> key.

Machining of the workpiece is started.

Note

Program selection from external media

If you execute programs from an external drive (e.g. network drive), you require the "Execution from external storage (EES)" software option.

14.4 Creating a directory / program / job list / program list

14.4.1 File and directory names

The following rules are to be observed when assigning names to files and directories:

- All letters are permissible (with the exception of umlauts, special characters, language-specific special characters, Asian or Cyrillic characters)
- All digits
- Underscores (_).
- The name can be a maximum of 24 characters long

Note

To avoid problems with Windows applications, do **not** use the following terms as program names or directory titles:

- CON, PRN, AUX, NUL
- COM1, COM2, COM3, COM4, COM5, COM6, COM7, COM8, COM9
- LPT1, LPT2, LPT3, LPT4, LPT5, LPT6, LPT7, LPT8, LPT9

Please note that these terms, including those with extensions (e.g. LPT1.MPF, CON.INI) can lead to problems if they are transferred to a Windows environment by copying, archiving or uploading, for example.

14.4.2 Creating a new directory

Directory structures help you to manage your program and data transparently. At all storage locations, you can create subdirectories for this purpose in a directory.

In a subdirectory, in turn, you can create programs and then create program blocks for them.

Note

Restrictions

- Directory names must end in .DIR or .WPD.
 - The maximum name length is 28 characters including the extension.
 - The maximum path length for nested workpieces, including all supplementary characters, is 100 characters.
 - These names are automatically converted to upper-case letters.
This limitation does not apply for work on USB/network drives.
-

Procedure



1. Select the "Program manager" operating area.



2. Select the desired storage medium, i.e. a local or USB drive.



3. If you want to create a new directory in the local network, place the cursor on the topmost folder and press the "New" and "Directory" softkeys. The "New Directory" window opens.



4. Enter the desired directory name and press the "OK" softkey.

14.4.3 Creating a new workpiece

You can create various types of files such as main programs, initialization files, tool offsets, etc. in a workpiece.

Note

Workpiece directories

You have the option of nesting tool directories. Please note that the length of the call line is restricted. You will be informed if the maximum number of characters is reached when entering the workpiece name.

Procedure



1. Select the "Program manager" operating area.



2. Select the required storage location.



3. Position the cursor on the folder in which you would like to create a workpiece.



4. Press the "New" softkey. The "New Workpiece" window appears.

5. If necessary, select a template if any are available.

14.4 Creating a directory / program / job list / program list



6. Enter the desired workpiece name and press the "OK" softkey.

A new folder with the workpiece name will be created.

The directory type (WPD) is set by default.

The "New G Code Program" window opens.



7. Press the "OK" softkey again if you want to create the program.

The program will open in the editor.

14.4.4 Creating a new G code program

You can create G code programs and then render G code blocks for them in a directory/workpiece.

Procedure



1. Select the "Program manager" operating area.

2. Select the desired storage location and position the cursor on the folder in which you would like to store the program.



3. Press the "New" softkey.



The "New G Code Program" window opens.

4. If necessary, select a template if any are available.

5. Select the file type (MPF or SPF).

If you are in the NC memory and have selected either the "Subprograms" or "Part programs" folder, you can only create one subprogram (SPF) or one main program (MPF).



6. Enter the desired program name and press the "OK" softkey.

14.4.5 New ShopTurn program

In the part program and workpiece directories, you can create ShopTurn programs and then subsequently generate the machining steps for them.

Procedure



1. Select the "Program manager" operating area.



2. Select the desired storage location and position the cursor on the folder in which you would like to store the program.



3. Press the "New" softkey.

4. Press the "ShopTurn" softkey.
The "New Step Sequence Program" window opens.
The "ShopTurn" type is specified.



5th Enter the desired program name and press the "OK" softkey.

14.4.6 Storing any new file

In each directory or subdirectory you can create a file in any format that you specify.

Note

File extensions

In the NC memory, the extension must have 3 characters, and DIR or WPD are not permitted.

In the NC memory, you can create the following file types under a workpiece using the "Any" softkey.



Procedure



1. Select the "Program manager" operating area.



2. Select the desired storage location and position the cursor on the folder in which you would like to create the file.



3. Press the "New" and "Any" softkeys.
The "Any New Program" window opens.

4. Select a file type from the "Type" selection field (for example, "Definitions GUD") and enter the name of the file to be created when you have selected a workpiece directory in the NC memory.
The file automatically has the selected file format.

- OR -

Enter a name and file format for the file to be created (e.g. My_Text.txt).



5. Press the "OK" softkey.

14.4.7 Creating a job list

For every workpiece, you can create a job list for extended workpiece selection.

In the job list, you specify instructions for program selection in different channels.

Syntax

The job list contains the SELECT instructions.

SELECT <program> CH=<channel number> [DISK]

The SELECT instruction selects a program for execution in a specific NC channel. The selected program must be loaded into the working memory of the NC. The DISK parameter enables the selection of external execution (CF card, USB data carrier, network drive).

- <Program>
Absolute or relative path specification of the program to be selected.
Examples:
 - //NC/WCS.DIR/SHAFT.WPD/SHAFT1.MPF
 - SHAFT2.MPF
- <Channel number>
Number of the NC channel in which the program is to be selected.
Example:
CH=2
- [DISK]
Optional parameter for programs that are not in the NC memory and are to be executed "externally".
Example:
SELECT //remote/myshare/shaft3.mpf CH=1 DISK

Comment

Comments are identified in the job list by ";" at the start of the line or by round brackets.





Template

You can select a template from Siemens or the machine manufacturer when creating a new job list.

Executing a workpiece

If the "Select" softkey is selected for a workpiece, the syntax of the associated job list is checked and then executed. The cursor can also be placed on the job list for selection.

Procedure

1.  Select the "Program manager" operating area.
2.  Press the "NC" softkey, and in directory "Workpieces" place the cursor on the program for which you wish to create a job list.
3.  Press the "New" and "Any" softkeys.
The "Any New Program" window opens.
4.  Select entry "Job list JOB" from the "Type" selection field and enter a name and press the "OK" softkey.

14.4.8 Creating a program list

You can also enter programs in a program list that are then selected and executed from the PLC.

The program list may contain up to 100 entries.



Machine manufacturer

Please refer to the machine manufacturer's specifications.

Procedure



1. Select the "Program manager" operating area.



2. Press the menu forward key and the "Program list" softkey. The "Prog.-list" window opens.



3. Place the cursor in the desired line (program number).



4. Press the "Select program" softkey.

The "Programs" window opens. The data tree of the NC memory with workpiece, part program and subprogram directory is displayed.



5. Place the cursor on the desired program and press the "OK" softkey.

The selected program is inserted in the first line of the list together with its path.

- OR -

Enter the program name directly in the list.

If you are making entries manually, check that the path is correct (e.g. // NC/WKS.DIR/MEINPROGRAMM.WPD/MEINPROGRAMM.MPF).

//NC and the extension (.MPF) may be added automatically.

With multi-channel machines, you can specify in which channel the program is to be selected.



6. To remove a program from the list, place the cursor on the appropriate line and press the "Delete" softkey.

- OR -



To delete all programs from the program list, press the "Delete all" softkey.

14.5 Creating templates

You can store your own templates to be used for creating part programs and workpieces. These templates provide the basic framework for further editing.

You can use them for any part programs or workpieces you have created.

Storage location for templates

The templates used to create part programs or workpieces are stored in the following directories:

HMI Data/Templates/Manufacturer/Part programs or Workpieces

HMI Data/Templates/User/Part programs or Workpieces

Procedure

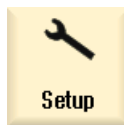

1. Select the "Start-up" operating area.

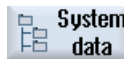

2. Press the "System data" softkey.



3. Position the cursor on the file that you wish to store as a template and press the "Copy" softkey.



4. Select the directory in which you want to store the data - "Part programs" or "Workpieces" - and press the "Paste" softkey.

Stored templates can be selected when a part program or a workpiece is being created.

14.6 Searching directories and files

You have the possibility of searching in the Program Manager for certain directories and files.

Note

Search with place holders

The following place holders simplify the search:

- "*": Replaces any character string
- "?": Replaces any character

If you use place holders, only directories and files are found that correspond exactly to the search pattern.

Without place holders, directories and files are found that contain the search pattern at an arbitrary position.

Search strategy

The search is made in all of the selected directories and their subdirectories.

If the cursor is positioned on a file, then a search is made from the higher-level directory.

Note

Searching in opened directories

Open the closed directories for a successful search.

Procedure



1. Select the "Program Manager" operating area.



2. Select the storage location in which you wish to perform the search and then press the ">>" and "Search" softkeys.



The "Find File" window opens.

3. Enter the desired search term in the "Text" field.

Note: When searching for a file with place holders, enter the complete name with extension (e.g. DRILLING.MPF).

4. When required, activate the "Observe upper and lower case" checkbox.

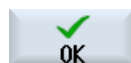

5. Press the "OK" softkey to start the search.

6. If a corresponding directory or file is found, then it is marked.



7. Press the "Continue search" and "OK" softkeys if the directory or the file does not correspond to the required result.



- OR -



Press the "Cancel" softkey when you want to cancel the search.

14.7 Displaying the program in the Preview.

You can show the content on a program in a preview before you start editing.

Procedure



1. Select the "Program manager" operating area.



2. Select a storage location and place the cursor on the relevant program.
3. Press the ">>" and "Preview window" softkeys.
The "Preview: ..." window opens.



4. Press the "Preview window" softkey again to close the window.

14.8 Selecting several directories/programs

You can select several files and directories for further processing. When you select a directory, all directories and files located beneath it are also selected.

Note

Selected files

If you have selected individual files in a directory, then this selection is canceled when the directory is closed.

If the complete directory with all of the files included in it are selected, then this selection is kept when closing the directory.

Procedure



1. Select the "Program manager" operating area.



2. Choose the desired storage location and position the cursor on the file or directory from which you would like your selection to start.

3. Press the "Select" softkey.



The softkey is active.

4. Select the required directories/programs with the cursor keys or mouse.







5. Press the "Select" softkey again to deactivate the cursor keys.



Canceling a selection

By reselecting an element, the existing selection is canceled.

Selecting via keys

Key combination	Meaning
	Renders or expands a selection. You can only select individual elements.
  	Renders a consecutive selection.
	A previously existing selection is canceled.

Selecting with the mouse

Key combination	Meaning
Left mouse	Click on element: The element is selected. A previously existing selection is canceled.
Left mouse +  Pressed	Expand selection consecutively up to the next click.
Left mouse +  Pressed	Expand selection to individual elements by clicking. An existing selection will expand to include the element you clicked.

14.9 Copying and pasting a directory/program

To create a new directory or program that is similar to an existing program, you can save time by copying the old directory or program and only changing selected programs or program blocks.

The capability of copying and pasting directories and programs can also be used to exchange data with other systems via USB/network drives (e.g. USB FlashDrive).

Copied files or directories can be pasted at a different location.

Note

You can only paste directories on local drives and on USB or network drives.

Note

Write rights

If the current directory is write-protected for the user, then the function is not listed.

Note

When you copy directories, any missing endings are added automatically.

All letters (except accented characters), numbers, and underscores are permitted when assigning names. The names are automatically converted to upper-case letters, and extra dots are converted to underscores.

Example

If the name is not changed when copying, a copy is created automatically:

MYPROGRAM.MPF is copied to MYPROGRAM__1.MPF. The next time it is copied, it is changed to MYPROGRAM__2.MPF, etc.

If the files MYPROGRAM.MPF, MYPROGRAM__1.MPF, and MYPROGRAM__3.MPF already exist in a directory, MYPROGRAM__2.MPF is created as the next copy of MYPROGRAM.MPF.

Procedure



1. Select the "Program Manager" operating area.
2. Choose the desired storage location and position the cursor on the file or directory which you would like to copy.
3. Press the "Copy" softkey.
4. Select the directory in which you want to paste your copied directory/program.

14.9 Copying and pasting a directory/program



5. Press the "Paste" softkey.

An appropriate note is displayed if a directory/program with the same name exists in this directory. You are requested to assign a new name, otherwise the directory/program is assigned a name by the system. If the name contains illegal characters or is too long, a prompt will appear for you to enter a permissible name.



6. Press the "OK" or "Overwrite all" softkey if you want to overwrite existing directories/programs.



- OR -



Press the "No overwriting" softkey if you do not want to overwrite already existing directories/programs.

- OR -



Press the "Skip" softkey if the copy operation is to be continued with the next file.

- OR -



Enter another name if you want to paste the directory/program under another name and press the "OK" softkey.

Note

Copying files in the same directory

You cannot copy files to the same directory. You must copy the file under a new name.

14.10 Deleting a directory/program

Delete programs or directories from time to time that you are no longer using to maintain a clearer overview of your data management. Back up the data beforehand, if necessary, on an external data medium (e.g. USB FlashDrive) or on a network drive.

Please note that when you delete a directory, all programs, tool data and zero point data and subdirectories that this directory contains are deleted.

Temp directory for ShopTurn

If you want to free up space in the NCK memory, delete the contents of the "TEMP" directory. This is where ShopTurn stores the programs that are created internally for calculating solid machining operations.

Procedure



1. Select the "Program manager" operating area.



2. Choose the desired storage location and position the cursor on the file or directory that you would like to delete.

3. Press the ">>" and "Delete" softkeys.

A prompt appears as to whether you really want to delete the file or directory.

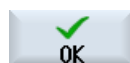

4. Press the "OK" softkey to delete the program/directory.

- OR -



Press the "Cancel" softkey to cancel the process.

14.11 Changing file and directory properties

Information on directories and files can be displayed in the "Properties for ..." window.

Information on the creation date is displayed near the file's path and name.

You can change names.

Changing access rights

Access rights for execution, writing, listing and reading are displayed in the "Properties" window.

- Execute: Is used for the selection for execution
- Write: Controls the changing and deletion of a file or a directory

For NC files, you have the option to set the access rights from keyswitch 0 to the current access level, to be set separately for each file.

If an access level is higher than the current access level, it cannot be changed.

For external files (e.g. on a local drive), the access rights are displayed to you only if settings have been executed for these files by the machine manufacturer. They cannot be changed via the "Properties" window.

Settings for the access rights to directories and files

Via a configuration file and MD 51050, access rights of the directories and file types of the NC and user memory (local drive) can be changed and pre-assigned.

References

A detailed description of the configuration can be found in the following documentation:

SINUMERIK Operate Commissioning Manual

Procedure



1. Select the program manager.



2. Choose the desired storage location and position the cursor on the file or directory whose properties you want to display or change.



3. Press the ">>" and "Properties" softkeys. The "Properties from ..." window appears.



4. Enter any necessary changes.

Note: You can save changes via the user interface in the NC memory.

5. Press the "OK" softkey to save the changes.



14.12 Set up drives

14.12.1 Overview

Up to 21 connections to so-called logical drives (data carriers) can be configured. These drives can be accessed in the "Program manager" and "Startup" operating areas.

The following logical drives can be set up:

- USB interface
- Network drives
- CompactFlash card
- CompactFlash card of the NCU, only for SINUMERIK Operate in the NCU (for 840D sl)
- Local hard disk of the PCU, only for SINUMERIK Operate on the PCU (for 840D sl)



Software option – for 840D sl

In order to use the CompactFlash card as a data carrier, you require the option "Additional HMI user memory on CF card of NCU" (not for SINUMERIK Operate on PCU/PC).



Software option – for 828D

You will need the "Manage network drives" option to manage additional drives via Ethernet.

Note

The USB interfaces of the NCU are not available for SINUMERIK Operate and can therefore not be configured (for 840D sl).

14.12.2 Setting up drives

The "Set Up Drives" window is available in the "Start-up" operating area for configuring the softkeys in the Program Manager.

Note

Reserved softkeys

Softkeys 4, 7 and 16 are not available to be freely configured.



Machine manufacturer

Please refer to the machine manufacturer's specifications.

File

The created configuration data is stored in the "logdrive.ini" file. This file is located in the /user/sinumerik/hmi/cfg directory.

General information

Entry		Meaning
Drives 1 - 24		
Type	No drive	No drive defined
	NC program memory	Access to the NC memory
	USB local	Access to the USB interface of the active operator unit
	USB global	All of the TCUs in the plant network can access the USB memory medium.
	NW Windows	Network drive in Windows systems.
	NW Linux	Network drive in Linux systems.
	Local drive	Local drive. Hard disk or user memory on the CompactFlash card.
	FTP	Access to an external FTP server. The drive cannot be used as global part program memory.
	User cycles	Access to the user cycle directory of the CompactFlash card
	Manufacturer cycles	Access to the manufacturer cycle directory of the CompactFlash card
	Drive Windows	Access to a local PCU/PC directory.

Specifications for USB

Entry		Description
Device		Names of the TCU to which the USB storage medium is connected, e.g. tcu1. The NCU must already know the TCU name.
Connection	Front	USB interface that is located at the front of the operator panel.
	X203/X204	USB interface X203/X204 that is located at the rear of the operator panel.
	X61/X62	For SIMATIC Thin Client, the USB interfaces are X61 and X62.
	X212/X213	TCU20.2/20.3
	X20	OP 08T
	X60.P1/P2/P3/P4	PCU
Symbolic		Symbolic drive name.
Additional parameters under Details		

Entry		Description
Partition		Partition number on the USB storage medium, e.g. 1 or all. If a USB hub is being used, then specify the USB port of the hub.
USB path		Path to the USB hub. Note: This value is not currently evaluated.

Specifications for local drives

Entry		Description
Symbolic		Symbolic drive name. Assignment of the names under Details
Additional parameters under Details		
Use drive as:	LOCAL_DRIVE	The activation of the checkbox assigns the symbolic name to the drive.
	CF_CARD	
	SYS_DRIVE	If an assignment exists already for the drive, no change can be made. All checkboxes are active as preassignment.

Specifications for network drives

Entry		Description
Computer name		Logical name of the server or the IP address.
Release name	Only for network drives in Windows systems.	Name, under which the network drive was released
Path		Start directory. The path is specified relative to the released directory.
User name Password		Enter the user name and the corresponding password for which the directory is enabled on the server. The password is displayed in encoded form as string of "*" characters and is stored in the "logdrive.ini" file.
Symbolic		Symbolic drive name. Maximum 12 characters can be entered (letters, digits, underscore). The names NC, GDIR and FTP are reserved. They are also used to label the softkey if a softkey text is not specified.

Specifications for FTP

Entry		Description
Computer name		Logical name of the FTP server or the IP address.
Path		Start directory on the FTP server. The path is specified relative to the home directory.
User name Password		User names and the associated password for login to the FTP server. The password is displayed in encoded form as string of "*" characters and is stored in the "logdrive.ini" file.
Additional parameters under Details		
Port		Interface for the FTP connection. The default port is 21.
Disconnect		After a disconnect timeout, the FTP connection is disconnected. The timeout can be between 1 and 150 s. 10 s is the default setting.

Additional specifications when using the "Execution from external storage (EES)" function



**Machine manufacturer**

Please refer to the machine manufacturer's specifications.

Entry		Description
Enable drive	Only for "Drive Windows (PCU)" type	The drive is enabled in the network. A user name is required. The checkbox must be activated if the local drive serves as global part program memory.
Global part program memory	Only for local drives, network drives and global USB drives	The checkbox indicates that all system nodes have access to the configured logical drive. The nodes can directly execute part programs from the drive. The setting can only be changed under Details.
Use this drive for EES program execution	Only for USB drives	Allows a local USB storage medium to be used to execute programs using EES.
Additional parameters under Details		

Entry		Description
Windows user name Windows password	Only for USB drives, local drives and local directories	User name and the associated password for release of the configured drive. The specifications from the "Global Settings" window are used as default setting.
Global part program memory	Only for local drives, network drives and global USB drives	The checkbox defines whether all system nodes have access to the configured logical drive. Only one drive can be selected as global part program memory (GDIR). If another drive has already been defined as GDIR and the checkbox is activated, the original setting is deleted.

Specifications for the configured softkey

Entry		Description
Access level		Assign access rights to the connections: From access level 7 (keyswitch position 0) to access level 1 (manufacturer). The particular assigned access level applies to all operating areas.
Softkey text		Two lines are available as labeling text for the softkey. %n is accepted as a line separator. If the first line is too long, then a line break is automatically inserted. If a space is present, it is taken as a line separator. For language-dependent softkey texts, the text ID is entered, which is used to search in the text file. If nothing is specified in the entry field, then the symbolic drive name is used as softkey text.
Softkey icon	No icon	No icon is displayed on the softkey.
	sk_usb_front.png 	File names of the icon displayed on the softkey.
	sk_local_drive.png 	
	sk_network_drive_ftp.png 	
Text file	slpmdialog	File for language-dependent softkey text. If nothing is specified in the input fields, the text appears on the softkey as was specified in the "Softkey text" input field.
Text context	SIPmDialog	

Procedure



1. Select the "Start-up" operating area.



2. Press the "HMI" and "Log. drive" softkeys.
The "Set Up Drives" window opens.

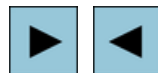

3. Select the softkey that you want to configure.



4. To configure softkeys 9 to 16 or softkeys 17 to 24, click the ">> level" softkey.



5. To allow entry fields to be edited, press the "Change" softkey.



6. Select the data for the corresponding drive or enter the necessary data.
7. Press the "Details" softkey if you want to enter additional parameters.
Press the "Details" softkey to return to the "Set Up Drives" window.



8. Press the "OK" softkey.
The entries are checked.

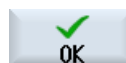

A window with the appropriate message opens if the data is incomplete or incorrect. Acknowledge the message with "OK" softkey.



If you press the "Cancel" softkey, then all of the data that has not been activated is rejected.

9. Restart the control in order to activate the configuration and to obtain the softkeys in the "Program Manager" operating area.

Entering the default settings for drive release

Note

This function is available only on Windows systems when the "Execution from external storage (EES)" software option is activated.

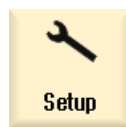

1. Select the "Start-up" operating area.



2. Press the "HMI" and "Log. drive" softkeys.
The "Set Up Drives" window opens.





3. Press the "Glob. settings" softkey.



4. Enter the user name and the associated password for the configured drives to be released.

5. Press the "OK" softkey.

The specifications are transferred as default setting for the Windows release.



If you press the "Cancel" softkey, then all of the data that has not been activated is rejected.

14.13 Viewing PDF documents

You have the option of displaying HTML documents, as well as PDFs, on all drives of the program manager via the data tree of the system data.

Note

A preview of the documents is only possible for PDFs.

Procedure



1. In the "Program manager" operating area, select the desired storage medium.



- OR -



Select the desired storage location in the "Commissioning" operating area in the data tree of the "System data".



2. Position the cursor on the PDF or the HTML file that you want to display, and press the "Open" softkey.

The selected file is displayed on the screen.

The storage path of the document is displayed in the status bar. The current page as well as the total number of pages of the document are displayed.



3. Press the "Zoom +" or "Zoom -" softkey to enlarge or reduce the size of the display.



4. Press the "Search" softkey if you want to search for specific texts in the PDF.



5. Press the "View" softkey to change the representation of the PDF. A new vertical softkey bar appears.

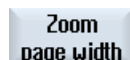

6. Press the "Zoom page width" softkey to display the document in full width on the screen.

- OR -



Press the "Zoom page height" softkey to display the document with full height on the screen.

- OR -



Press the "Rotate left" softkey to rotate the document through 90 degrees to the left.

- OR -



Press the "Rotate right" softkey to rotate the document through 90 degrees to the right.



7. Press the "Back" softkey to return to the previous window.



8. Press the "Close" softkey to exit the PDF display.

14.14 EXTCALL

The EXTCALL command can be used to access files on a local drive, USB data carriers or network drives from a part program.

The programmer can set the source directory with the setting data SD \$SC42700 EXT_PROG_PATH and then specify the file name of the subprogram to be loaded with the EXTCALL command.

Supplementary conditions

The following supplementary conditions must be taken into account with EXTCALL calls:

- You can only call files with the MPF or SPF extension via EXTCALL from a network drive.
- The files and paths must comply with the NCK naming conventions (max. 25 characters for the name, 3 characters for the identifier).
- A program is found on a network drive with the EXTCALL command if
 - with SD \$SC42700 EXT_PROG_PATH the search path refers to the network drive or a directory contained on the network drive. The program must be stored directly on that level, no subdirectories are searched.
 - without SD \$SC42700 the correct location of the program is specified in the EXTCALL call itself by means of a fully qualified path that can also point to a subdirectory of the network drive.
- For programs that were generated on external storage media (Windows system) observe upper- and lower-case syntax.

Note

Maximum path length for EXTCALL

The path length must not exceed 112 characters. The path comprises the contents of the setting data (SD \$SC42700) and the path data for EXTCALL call from the part program.

Examples of EXTCALL calls

The setting data can be used to perform a targeted search for the program.

- Call of USB drive on TCU (USB storage device on interface X203), if SD42700 is empty:
e.g. EXTCALL "//TCU/TCU1 /X203 ,1/TEST.SPF"
- OR -
Call of USB drive on TCU (USB storage device on interface X203), if SD42700 "//TCU/TCU1 /X203 ,1" contains: EXTCALL "TEST.SPF"
- Call of the USB front connection (USB-FlashDrive), if SD \$SC 42700 is empty: e.g.
EXTCALL "//ACTTCU/FRONT,1/TEST.SPF"
- OR -
Call of USB front connection (USB-FlashDrive), if SD42700 "//ACTTCU/FRONT,1" contains: EXTCALL "TEST.SPF"

- Call of network drive, if SD42700 is empty: e.g. EXTCALL "//computer name/enabled drive/TEST.SPF"
- OR -
Call of the network drive, if SD \$SC42700 "//Computer name/enabled drive" contains:
EXTCALL "TEST.SPF"
- Use of the HMI user memory (local drive):
 - On the local drive, you have created the directories part programs (mpf.dir), subprograms (spf.dir) and workpieces (wks.dir) with the respective workpiece directories (.wpd):
SD42700 is empty: EXTCALL "TEST.SPF"
The same search sequence is used on the CompactFlash card as in the NCK part program memory.
 - On the local drive, you have created your own directory (e.g. my.dir):
Specification of the complete path: e.g. EXTCALL "/user/sinumerik/data/prog/my.dir/TEST.SPF"
A search is performed for the specified file.

Note

Abbreviations for local drive, CompactFlash card and USB front connection

As abbreviation for the local drive, the CompactFlash card and the USB front connection you can use the abbreviation LOCAL_DRIVE:, CF_CARD: and USB: (e.g. EXTCALL "LOCAL_DRIVE:/spf.dir/TEST.SPF").

Alternatively, you can also use the abbreviations CF_Card and LOCAL_DRIVE.



Software options

To display the "Local drive" softkey, you require option "Additional HMI user memory on CF card of the NCU" (not for SINUMERIK Operate on PCU50 / PC).

NOTICE

Possible interruption when executing from USB FlashDrive

Direct execution from a USB-FlashDrive is not recommended.

There is no protection against contact problems, falling out, breakage through knocking or unintentional removal of the USB-FlashDrive during operation.

Disconnecting it during operation will result in immediate stopping of the machining and, thus, to the workpiece being damaged.



Machine manufacturer

Processing EXTCALL calls can be enabled and disabled.
Please refer to the machine manufacturer's specifications.

14.15 Execution from external memory (EES)

The "Execution from external storage" function allows you to directly execute any size of part program from an appropriately configured drive. The behavior is the same as that for execution from the NC part program memory without the restrictions that apply to "EXTCALL".



Software option

You require the "CNC user memory extended" software option in order to use this function in the user memory (100 MB) of the CompactFlash card.



Software option

In order to use this function without restrictions, e.g. for a network drive or a USB drive, you require the "Execution from external storage (EES)" software option.

Note

Not possible to teach-in program

When an EES program has been selected, it is not possible to teach-in programs.



Machine manufacturer

Please refer to the machine manufacturer's instructions.

You have the option of processing the G code programs saved on the configured external drives as usual in the editor.

When executing the G code programs, you obtain a current block display, as usual. You can edit the programs directly in the Reset state.

In addition to the current block display, you can also show a basic block display. You can make corrections with the "Program correction" function, as usual.

14.16 Backing up data

14.16.1 Generating an archive in the Program Manager

You have the option of archiving individual files from the NC memory and the local drive.

Archive formats

You have the option of saving your archive in the binary and punched tape format.

Save target

The archive folder of the system data in the "Startup" operating area as well as USB and network drives are available as save target.

Procedure



1. Select the "Program Manager" operating area.



2. Select the storage location for the file/files to be archived.

3. In the directories, select the required file from which you want to create an archive.

- OR -



If you want to back up several files or directories, press the "Select" softkey.

Make the selection using the cursor keys or mouse.



4. Press the ">>" and "Archive" softkeys.



5. Press the "Generate archive" softkey.

The "Generate Archive: Select archiving" window opens.



6. Position the cursor to the required storage location, press the "Search" softkey, enter the required search term in the search dialog and press the "OK" softkey if you wish to search for a specific directory or subdirectory.



Note: The place holders "*" (for any character string) and "?" (for any character) make it easier for you to perform a search.

- OR -



Select the required storage location, press the "New directory" softkey, enter the required name in the "New directory" window and press the "OK" softkey to create a directory.





7. Press "OK".

The "Generate Archive: Name" window opens.



9. Select the format (e.g. archive ARC (binary format) for 840 sl or archive ARD for 828D), enter the desired name and press the "OK" softkey.

A message informs you if archiving was successful.

14.16.2 Generating an archive via the system data

If you only want to backup specific data, then you can select the desired files directly from the data tree and generate an archive.

Archive formats

You have the option of saving your archive in the binary and punched tape format.

You can display the content of the selected files (XML, ini, hsp, syf files, programs) using a preview.

You can display information about the file, such as path, name, date of creation and change, in a Properties window.

Precondition

The access rights depend on the relevant areas and range from protection level 7 (key switch position 0) to protection level 2 (password: Service).

Storage locations

- CompactFlash card under
/user/sinumerik/data/archive, or
/oem/sinumerik/data/archive
- All configured logical drives (USB, network drives)



Software option

In order to save archives on the CompactFlash Card in the user area you require the "Additional HMI user memory on CF card of NCU" option.

NOTICE

Possible data loss when using USB flash drives

USB-FlashDrives are not suitable as persistent memory media.

Procedure

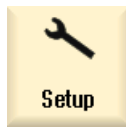

1. Select the "Startup" operating area.



2. Press the "System data" softkey.
The data tree opens.

3. In the data tree, select the required files from which you want to generate an archive.

- OR -



If you want to back up several files or directories, press the "Select" softkey.

Make the selection using the cursor keys or mouse.



4. If you press the ">>" softkey, further softkeys are displayed on the vertical bar.



5. Press the "Preview window" softkey.

The contents of the selected file are displayed in a small window.

Press the "Preview window" softkey again to close the window.



6. Press the "Properties" softkey.

Information about the selected file is displayed in a small window.

Press the "OK" softkey to close the window.



7. Press the "Search" softkey.

Enter the required search term in the search dialog and press the "OK" softkey if you wish to search for a specific directory or subdirectory.

Note: The place holders "*" (for any character string) and "?" (for any character) make it easier for you to perform a search.



8. Press the "Archive" and "Generate archive" softkeys.

The "Generate Archive: Select Storage Location" window opens.

The "Archive" folder with the subfolders "User" and "Manufacturer" as well as the storage media (e.g. USB) are displayed.



9. Select the required location for archiving and press the "New directory" softkey to create a suitable subdirectory.

The "New Directory" window opens.

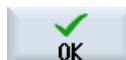

10. Enter the required name and press the "OK" softkey.

The directory is created below the selected folder.

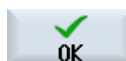

11. Press the "OK" softkey.

The "Generate Archive: Name" window opens.



12. Select the format (e.g. archive ARC (binary format) for 840D sl or archive ARD for 828D), enter the desired name and press the "OK" softkey to archive the file/files.

A message informs you if archiving was successful.



13. Press the "OK" softkey to confirm the message and end the archiving operation.

An archive file in the .ARC (840D sl) or .ARD (828D) format type is created in the selected directory.

14.16.3 Reading in an archive in the Program Manager

In the "Program Manager" operating area, you have the option of reading in archives from the archive folder of the system data as well as from configured USB and network drives.



Software option

In order to read-in user archives in the "Program Manager" operating area, you require the option "Additional HMI user memory on CF Card of NCU" (not for 840D sl / SINUMERIK Operate on PCU50 / PC).

Procedure



1. Select the "Program Manager" operating area.



2. Press the "Archive" and "Read in archive" softkeys. The "Read in archive: Select archive" window opens.



3. Select the archive storage location and position the cursor on the required archive.

Note: When the option is not set, the folder for user archives is only displayed if the folder contains at least one archive.

- OR -



Press the "Search" softkey and in the search dialog, enter the name of the archive file with file extension (*.arc) for 840D sl or with file extension (*.ard) for 828D if you wish to search for a specific archive and press the "OK" softkey.



4. Press the "OK" or "Overwrite all" softkey to overwrite existing files.

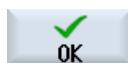

...





- OR -

Press the "Do not overwrite" softkey if you do not want to overwrite already existing files.



- OR -

Press the "Skip" softkey if the read-in operation is to be continued with the next file.

The "Read In Archive" window opens and a progress message box appears for the read-in process.

You will then obtain a "Read error log for archive" in which the skipped or overwritten files are listed.



5. Press the "Cancel" softkey to cancel the read-in process.

See also

Searching directories and files (Page 784)

14.16.4 Read in archive from system data

If you want to read in a specific archive, you can select this directly from the data tree.

Procedure

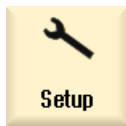

1. Select the "Startup" operating area.



2. Press the "System data" softkey.

3. In the data tree below the "Archive" directory, in the "User" folder, select the file that you wish to read in.



4. Press the "Read in" softkey.



5. Press the "OK" or "Overwrite all" softkey to overwrite existing files.

...



- OR -

Press the "Do not overwrite" softkey if you do not want to overwrite already existing files.

- OR -



Press the "Skip" softkey if the read-in operation is to be continued with the next file.

The "Read In Archive" window opens and a progress message box appears for the read-in process.

You will then obtain a "Read error log for archive" in which the skipped or overwritten files are listed.



6. Press the "Cancel" softkey to cancel the read-in process.

14.17 Setup data

14.17.1 Backing up setup data

Apart from programs, you can also save tool data and zero point settings.

You can use this option, for example, to back up tools and zero point data for a specific machining step program. If you want to execute this program at a later point in time, you will then have quick access to the relevant settings.

Even tool data that you have measured on an external tool setting station can be copied easily into the tool management system using this option.

Backing-up job lists

If you wish to backup a job list, which contains ShopTurn and G code programs, you obtain dedicated selection boxes to backup the tool data and zero points.

Note

Backing up setup data from part programs

Setup data from part programs can only be backed up if they have been saved in the "Workpieces" directory.

For part programs, which are located in the "Part programs" directory, "Save setup data" is not listed.

Backing up data

Data	
Tool data	<ul style="list-style-type: none"> • No • All used in the program (only for ShopTurn program and job list only with ShopTurn programs) • Complete tool list
Tool data for ShopTurn programs -- only available for job list with ShopTurn and G code programs	<ul style="list-style-type: none"> • No • All used in the program • Complete tool list
Tool data for G code programs -- only available for job list with ShopTurn and G code programs	<ul style="list-style-type: none"> • No • Complete tool list
Magazine assignment	<ul style="list-style-type: none"> • Yes • No

Data	
Zero points	<ul style="list-style-type: none"> • No The selection box "Basis zero point" is hidden • All used in the program (only for ShopTurn program and job list only with ShopTurn programs) • All
Zero points for ShopTurn programs -- only available for job list with ShopTurn and G code programs	<ul style="list-style-type: none"> • No The selection box "Basis zero point" is hidden • All used in the program • Complete tool list
Zero points for G code programs -- only available for job list with ShopTurn and G code programs	<ul style="list-style-type: none"> • No The selection box "Basis zero point" is hidden • All
Basic zero points	<ul style="list-style-type: none"> • No • Yes
Directory	The directory is displayed, in which the selected program is located.
File name	Here you have the option of changing the suggested file names.

Note

Magazine assignment

You can only read out the magazine assignments if your system provides support for loading and unloading tool data to and from the magazine.

Procedure



1. Select the "Program Manager" operating area.



2. Position the cursor on the program whose tool and zero point data you wish to back up.

...



3. Press the ">>" and "Archive" softkeys.

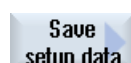

4. Press the "Setup data" softkey.
The "Backup setup data" window opens.

5. Select the data you want to back up.
6. When required, change the specified name of the originally selected program here in the "File name" field.
7. Press the "OK" softkey.
The setup data will be set up in the same directory in which the selected program is stored.
The file is automatically saved as INI file.



Note

Program selection

If a main program as well as an INI file with the same name are in a directory, when selecting the main program, initially, the INI file is automatically started. In this way, unwanted tool data can be changed.



Machine manufacturer

Please refer to the machine manufacturer's specifications.

14.17.2 Reading-in set-up data

When reading-in, select which of the backed-up data you require:

- Tool data
- Magazine assignment
- Zero points
- Basic zero point

Tool data

Depending on which data you have selected, the system behaves as follows:

- Complete tool list
First, all tool management data are deleted and then the saved data are imported.
- All tool data used in the program
If at least one of the tools to be read in already exists in the tool management system, you can choose between the following options.



Select the "Replace all" softkey to import all tool data. Any existing tools will now be overwritten without a warning prompt.

- OR -



Press the "Do not overwrite" softkey if existing tools must not be overwritten.

Already existing tools are skipped, without you receiving any queries.



- OR -

Press the "Skip" softkey if already existing tools are not to be overwritten. For an already existing tool, you receive a query.

Selecting loading point

For a magazine, if more than one loading point was set-up, using the "Select loading point" softkey, you have the option of opening a window in which you can assign a loading point to a magazine.

Procedure



1. Select the "Program Manager" operating area.



2. Position the cursor on the file with the backed-up tool and zero point data (*.INI) that you wish to re-import.



3. Press the <Cursor right> key

- OR -

Double-click the file.

The "Read-in setup data" window opens.



4. Select the data (e.g. magazine assignment) that you wish to read-in.

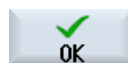

5. Press the "OK" softkey.

14.18 Backing up parameters

In addition to the programs, you can also save R-parameters and global user variables.

You can use this option, for example, to back up the required arithmetic parameters and user variables for a specific program. If you want to execute this program at a later point in time, you will then have quick access to the relevant data.

Note

Backing up parameters from part programs

Parameters from part programs can only be backed up if they have been saved in the "Workpieces" directory.

For part programs that are located in the "Part programs" or "Subprograms" directory, "Save parameters" is not listed.

Backing up data

Which data is offered for backup depends on the machine configuration:

Data	
R parameters	<ul style="list-style-type: none"> • No • Yes - all channel-specific arithmetic parameters
Global R parameters	<ul style="list-style-type: none"> • No • Yes - all global arithmetic parameters
UGUD parameters	<ul style="list-style-type: none"> • No • Yes - all channel-specific variables of the user
Global UGUD parameters	<ul style="list-style-type: none"> • No • Yes - all global variables of the user
MGUD parameters	<ul style="list-style-type: none"> • No • Yes - all channel-specific variables of the machine manufacturer
Global MGUD parameters	<ul style="list-style-type: none"> • No • Yes - all global variables of the machine manufacturer
Directory	The directory is displayed, in which the selected program is located.
File name	Here you have the option of changing the suggested file names.

For multi-channel machines, the parameters of the active channel are always backed up.

Job lists

If you select Back up parameters for a job list, the parameters of all programs that it contains are backed up.

The name of the job list does not agree with the names of the programs it contains. To nevertheless permit the unique assignment of the parameter files, they are always assigned the same name as the associated program. You cannot change these file names.

Procedure



1. Select the "Program Manager" operating area.



2. Select the drive on which the program is saved.

...



3. Position the cursor on the program whose parameters you want to back up.



4. Press the ">>" and "Archive" softkeys.



5. Press the "Save parameters" softkey.
The "Save parameters" window appears.

6. Select the data you want to back up.



7. Press the <CHANNEL> key or click on the channel display if you want to change the active channel.

- OR -



8. Change the specified name of the originally selected program in the "File name" field as required.



9. Press the "OK" softkey.
The parameters are saved in the same directory in which the selected program is stored.
The R-parameters (*.RPA) and the user variables (*.GUD) are saved in separate files.

Note

Program selection

If a directory contains a main program as well as an RPA file or a GUD file with the same name, initially these files are automatically started when the main program is selected. Tool data or parameters may accidentally be changed as a result.



Machine manufacturer

Please refer to the machine manufacturer's instructions.

14.19 RS-232-C

14.19.1 Reading-in and reading-out archives via a serial interface

You have the option of reading out and reading in archives in the "Program manager" operating area as well as in the "Startup" operating area via the V24 serial interface.

Availability of the V24 serial interface

If you want to change the availability of the V24 interface, you can adjust the following parameters in file "slpmconfig.ini":

Parameters	Description
[V24]	Describes the section in which the relevant setting parameters are located.
useV24	Setting for the availability of the V24 serial interface
= true	Interface and softkeys are available (default)
= false	Interface and softkeys are not available

Storage of file "slpmconfig.ini"

The template of the file "slpmconfig.ini" for SINUMERIK Operate is stored in the following directory:

<Installation path>/siemens/sinumerik/hmi/template/cfg

Copy the file to one of the following directories:

<Installation path>/**user**/sinumerik/hmi/cfg

<Installation path>/**oem**/sinumerik/hmi/cfg

Note

If you want to achieve a better overview of the changes you have made yourself, simply delete the unchanged parameters from the file copy "slpmconfig.ini".

Reading-out archives

The files to be sent (directories, individual files) are zipped in an archive (*.arc). If you send an archive (*.arc), this is sent directly without being additionally zipped. If you have selected an archive (*.arc) together with an additional file (e.g. directory), then these are zipped into a new archive and are then sent.

Reading-in archives

Use interface V24 if you want to read in archives. They are transferred and then subsequently unzipped.

Note**Reading in commissioning archives**

When you read in a commissioning archive via the V24 interface, then this is immediately activated.

Externally processing the punched tape format

If you wish to externally process an archive, then generate this in the punched tape format.

Procedure



1. Select the "Program manager" operating area, and press the "NC" or "Local. drive" softkey.



...



- OR -

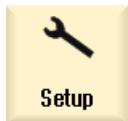

- Select the "Startup" operating area and press the "System data" softkey.



Reading-out archives



2. Select the directories or the files that you wish to send to V24.
3. Press the ">>" and "Archive" softkeys.



4. Press the "V24 send" softkey.

- OR -

Reading in an archive

Receive
RS-232-C

Press the "V24 receive" softkey if you wish to read-in files via V24.

14.19.2 Setting V24 in the program manager

V24 setting	Meaning
Protocol	The following protocols are supported for transfer via the V24 interface: <ul style="list-style-type: none"> • RTS/CTS (default setting) • Xon/Xoff
Transfer	Data transfer using a secured protocol (ZMODEM protocol): <ul style="list-style-type: none"> • Normal (default setting) • secure For the selected interface, secure data transfer is set in conjunction with handshake RTS/CTS.
Baud rate	Transfer rate: up to 115 kbaud data transfer rate. The baud rate that can be used depends on the connected device, the cable length and the general electrical conditions. <ul style="list-style-type: none"> • 110 • • 19200 (default) • ... • 115200
Archive format	<ul style="list-style-type: none"> • Punched tape format (default setting) • Binary format (PC format)
V24 settings (details)	
Interface	<ul style="list-style-type: none"> • COM1
Parity	Parity bits are used for error detection: The parity bits are added to the coded characters to make the number of positions set to "1" an uneven number (uneven parity) or to an even number (even parity). <ul style="list-style-type: none"> • None (default setting) • Odd • Even
Stop bits	Number of stop bits for asynchronous data transfer. <ul style="list-style-type: none"> • 1 (default) • 2
Data bits	Number of data bits for asynchronous data transfer. <ul style="list-style-type: none"> • 5 bits • ... • 8 bits (default setting)
XON (hex)	Only with protocol: Xon/Xoff
XOFF (hex)	Only with protocol: Xon/Xoff

V24 setting	Meaning
Wait for XON for start receive V24	Only with protocol: Xon/Xoff
End of data transfer (hex)	Only for punched tape format Stop with end of data transfer character The default setting for the end of data transfer character is (HEX) 1A
Time monitoring (sec)	Time monitoring For data transfer problems or at the end of data transfer (without end of data transfer character) data transfer is interrupted after the specified number of seconds. The time monitoring is controlled by a time generator (clock) that is started with the first character and is reset with each transferred character. The time monitoring can be set (seconds).

Procedure



1. Select the "Program Manager" operating area.



2. Press softkey "NC" or "Local Drive".



3. Press the ">>" and "Archive" softkeys.

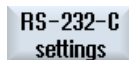

4. Select the "V24 settings" softkey.
Window "Interface: V24" is opened.

5. The interface settings are displayed.



6. Press the "Details" softkey if you wish to view and process additional settings for the interface.

Alarm, error and system messages

15.1 Displaying alarms

If the machine develops a fault in operation, an alarm is generated and machining is possibly interrupted.

The error text that is displayed together with the alarm number gives you more detailed information on the error cause.

You have the possibility of saving all of the relevant diagnostic data to a ZIP file, which you can subsequently send to the hotline for analysis.

 CAUTION
Dangers for persons and machines
Carefully check the system, based on the description of the active alarm(s). Resolve the cause of the alarms. Then acknowledge the alarms in the specified way.
Failure to observe this warning will place your machine, workpiece, saved settings and possibly even your own safety at risk.

Alarm overview

You can display all upcoming alarms and acknowledge them.

The alarm overview contains the following information:

- Date and time
- Cancel criterion
The delete criterion specifies the key or softkey that can be used to acknowledge the alarm.
- Alarm number
- Alarm text

Procedure

1. Select the "Diagnostics" operating area.

2. Press the "Alarm list" softkey.
The "Alarms" window appears.
All pending alarms are displayed.
The "Hide SI alarms" softkey is displayed if safety alarms are pending.

3. Press the "Hide SI alarms" softkey if you do not wish to display SI alarms.



15.1 Displaying alarms



4. Press softkey "Save diag. data" if the cause of the alarm is unknown. The function collects all available LOG files of the operating software and saves them to the following directory:
 \user\sinumerik\didac\out_<Date-Time>.7z
5. If there is a problem with the system, you can send the ZIP file to the SINUMERIK hotline to help with the analysis of the problem.

Cancel alarms

In the "Cancel" column it is symbolized how you delete the pending alarms from the alarm list.

6. Position the cursor on an alarm.
7. If an NCK-POWER ON alarm is displayed, turn the unit off and back on (main switch), or press NCK-POWER ON.
 - OR -
 If an NC-Start alarm is displayed, press the <NC-Start> key.
 - OR -
 If a RESET alarm is displayed, press the <RESET> key.
 - OR -
 If a Cancel alarm is displayed, press the <ALARM CANCEL> key or press the "Cancel Alarm delete" softkey.



- OR -



- OR -



If an HMI alarm is displayed, press the "Delete HMI alarm" softkey.

- OR -

If a dialog alarm of the HMI is displayed, press the <RECALL> key.

- OR -

If a PLC alarm is displayed, press the key provided by the machine manufacturer.

- OR -









If a PLC alarm of the type SQ is displayed, press the "Acknowl. alarm" softkey.

The softkeys are activated when the cursor is on the corresponding alarm.

Acknowledgement symbols

Symbol	Meaning
	NCK POWER ON
	NC start

Symbol	Meaning
	RESET alarm
	Cancel alarm
	HMI alarm
	Dialog alarms of the HMI
	PLC alarm
	PLC alarm of the SQ type (alarm number from 800000)
	Safety alarms

**Machine manufacturer**

Please refer to the machine manufacturer's instructions.

15.2 Displaying an alarm log

A list of all the alarms and messages that have occurred so far are listed in the "Alarm Log" window.

Up to 500 administered, incoming and outgoing events are displayed in chronological order.



Machine manufacturer

Please refer to the machine manufacturer's specifications.

Procedure



1. Select the "Diagnostics" operating area.



2. Press the "Alarm log" softkey.

The "Alarm Log" window opens.

All of the coming and going events - that have occurred since the HMI was started - are listed.



3. Press the "Display new" softkey to update the list of displayed alarms/ messages.



4. Press the "Save Log" softkey.

The log that is currently displayed is stored as text file alarmlog.txt in the system data in directory card/user/sinumerik/hmi/log/alarm_log.

15.3 Displaying messages

PLC and part program messages may be issued during machining.

These message will not interrupt the program execution. Messages provide information with regard to a certain behavior of the cycles and with regard to the progress of machining and are usually kept beyond a machining step or until the end of the cycle.

Overview of messages

You can display all issued messages.

The message overview contains the following information:

- Date
- Message number
is only displayed for PLC messages
- Message text

Procedure



1. Select the "Diagnostics" operating area.



2. Press the "Messages" softkey.
The "Messages" window appears.

15.4 Sorting, alarms, faults and messages

If a large number of alarms, messages or alarm logs are displayed, you have the option of sorting these in an ascending or descending order according to the following criteria:

- Date (alarm list, messages, alarm log)
- Number (alarm list, messages)

As a consequence, for every extensive lists, you can obtain the required information faster.

Procedure



1. Select the "Diagnostics" operating area.



2. Press the softkey "Alarm list", "Messages" or "Alarm log" to display the requested messages and alarms.

...



3. Press the "Sort" softkey.



The list of entries is sorted in descending (decreasing) order according to date, i.e. the most recent information is at the beginning of the list.



4. Press the softkey "Ascending" to sort the list in the ascending order. The most recent event is shown at the end of the list.



5. Press the "Number" softkey if you wish to sort the alarm list or the list with messages according to numbers.



6. Press the "Decreasing" softkey if you wish to display the list in a decreasing/descending order.

15.5 Creating screenshots

You can create screenshots of the current user interface.

Each screenshot is saved as a file and stored in the following folder:

`/user/sinumerik/hmi/log/screenshot`

Procedure

Ctrl + P Press the <Ctrl+P> key combination.

A screenshot of the current user interface is created in .png format.

The file names assigned by the system are in ascending order from "SCR_SAVE_0001.png" to "SCR_SAVE_9999.png". You can create up to 9,999 screenshots.

Copy file

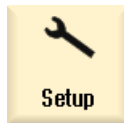

1. Select the "Startup" operating area.

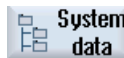

2. Press the "System data" softkey.



3. Open the folder specified above, and select the required screenshots.

4. Press the "Copy" softkey.

- OR -



Press the "Cut" softkey.



5. Open the required archive directory, e.g. on a USB flash drive and press the "Paste" softkey.

Note

You can also copy the screenshots using "WinSCP" to a Windows PC (for 840D sl).

Note

If you wish to view the screenshots, then you can open the files in SINUMERIK Operate. On a Windows PC, you can open the data using a graphic program, e.g. "Office Picture Manager". (for 840D sl)

15.6 PLC and NC variables

15.6.1 Displaying and editing PLC and NC variables

Changes can only be made to the NC/PLC variables with the appropriate password.

 WARNING Incorrect parameterization Changes in the states of NC/PLC variables have a considerable influence on the machine. Incorrect configuration of the parameters can endanger life and cause damage to the machine.

In the "NC/PLC Variables" window, enter the NC system variables and PLC variables that you want to monitor or change in the list:

- Variable
Address for NC/PLC variable.
Incorrect variables have a red background and are displayed with a # character in the value column.
- Comment
Any comment on the variable.
The columns can be displayed and hidden.
- Format
Specify the format in which the variable is to be displayed.
The format can be specified (e.g. floating point).
- Value
Displays the actual value of the NC/PLC variables.

PLC variables	
Inputs	<ul style="list-style-type: none"> • Input bit (Ex), input byte (EBx), input word (EWx), input double word (EDx) • Input bit (Ix), input byte (IBx), input word (IWx), input double word (IDx)
Outputs	<ul style="list-style-type: none"> • Output bit (Ax), output byte (ABx), output word (AWx), output double word (ADx) • Output bit (Qx), output byte (QBx), output word (QWx), output double word (QDx)
Bit memory	Memory bit (Mx), memory byte (MBx), memory word (MWx), memory double word (MDx)
Times	Time (Tx)
Counters	<ul style="list-style-type: none"> • Counter (Cx) • Counter (Cx)
Data	<ul style="list-style-type: none"> • Data block (DBx): Data bit (DBXx), data byte (DBBx), data word (DBWx), data double word (DBDx) • Data block (VBx): Data bit (VBXx), data byte (VBBx), data word (VBWx), data double word (VBDx)

Formats	
B	Binary
H	Hexadecimal
D	Decimal without sign
+/-D	Decimal with sign
F	Floating point (for double words)
A	ASCII character

Notation examples

Permissible notation for variables:

- PLC variables: EB2, A1.2, DB2.DBW2, VB32000002
- NC variables:
 - NC system variables: Notation \$AA_IM[1]
 - User variables / GUD: Notation GUD/MyVariable[1,3]
 - OPI notation: /CHANNEL/PARAMETER/R[u1,2]

Note

If the PLC user program writes a string into an NC/PLC variable, the string is only displayed correctly if the variable is parameterized on the NC side as a field variable of type "A" (ASCII).

Example of a field variable

Variable	Format
DBx.DBBy[<number>]	A

Inserting variables

The start value for "Filtering/searching" of variables differs. For example, to insert the variable \$R[0], enter the following start value:

- The start value is 0 if you filter according to "System variables".
- The start value is 1 if you filter according to "All (no filter)". In this case, all signals are displayed and shown in the OPI notation.

The GUD from the machine data is only displayed in the Search window for the variable selection when the associated definition file has been activated. Otherwise, the sought variables must be entered manually, e.g. GUD/SYG_RM[1]

The following machine data is representative for all variable types (INT, BOOL, AXIS, CHAR, STRING): MD18660 \$MN_MM_NUM_SYNACT_GUD_REAL[1].

Note

Display of NC/PLC variables

- System variables can be dependent on the channel. When the channel is switched over, the values from the selected channel are displayed.
You have the option of having the variables displayed channel-specifically, e.g. \$R1:CHAN1 and \$R1:CHAN2. The values of channel 1 and channel 2 are displayed, no matter in which channel you are.
- For user variables (GUD), it is not necessary to make a specification according to global or channel-specific GUD. The first element of a GUD array starts with index 0 as for NC variables.
- Using the tooltip, you can display the OPI notation for NC system variables (except for GUD).

Servo variables

Servo variables can only be selected and displayed at "Diagnostics" → "Trace".

Changing and deleting values



1. Select the "Diagnostics" operating area.



2. Press the "NC/PLC variables" softkey.

The "NC/PLC Variables" window opens.

3. Position the cursor in the "Variable" column and enter the required variable.



4. Press the <INPUT> key.

The operand is displayed with the value.



5. Press the "Details" softkey.

The "NC/PLC Variables: Details" window opens. The information for "Variable", "Comment" and "Value" is displayed in full length.



6. Position the cursor in the "Format" field and select the required format with <SELECT>.



7. Press the "Display comments" softkey.

The "Comments" column is displayed. You have the option of creating comments or editing existing comments.







Press the "Display comments" softkey once again to hide the column.

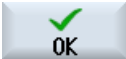

8. Press the "Change" softkey if you would like to edit the value.

The "Value" column can be edited.

- | | |
|---|---|
|  | 9. Press the "Insert variable" softkey if you wish to select a variable from a list of all existing variables and insert this.
The "Select Variable" window opens. |
|  | 10. Press the "Filter/search" softkey to restrict the display of variables (e.g. to mode group variables) using the "Filter" selection box and/or select the desired variable using the "Search" input box. |
|  | 11. Press the "Delete all" softkey if you would like to delete all the entries for the operands. |
|  | 12. Press the "OK" softkey to confirm the changes or the deletion. |
| - OR - | |
|  | Press the "Cancel" softkey to cancel the changes. |

Editing the variable list

You can edit the variable list using the "Insert line" and "Delete line" softkeys.



If you press the softkey, a new line inserted before the line marked by the cursor.

You can only use the "Insert line" softkey if there is at least one empty line at the end of the variable list.

The softkey is deactivated if there is no empty line.



If you press the "Delete line" softkey, the line marked by the cursor is deleted.

An empty line will be added at the bottom of the variable list.

Changing operands

Depending on the type of operand, you can increment or decrement the address by 1 place at a time using the "Operand +" and "Operand -" softkeys.

Note

Axis names as index

For axis names, the "Operand +" and "Operand -" softkeys do not act as index, e.g. for \$AA_IM[X1].



Examples

DB97.DBX2.5
Result: DB97.DBX2.6

\$AA_IM[1]
Result: \$AA_IM[2]



MB201
Result: MB200
/Channel/Parameter/R[u1,3]
Result: /Channel/Parameter/R[u1,2]

15.6.2 Saving and loading screen forms





You have the option of saving the configurations of the variables made in the "NC/PLC variables" window in a screen form that you reload again when required.

Editing screen forms

If you change a screen form that has been loaded, then this is marked using with * after the screen form name.

The name of a screen form is kept in the display after switching-off.

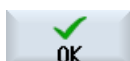
Procedure

1. You have entered values for the desired variables in the "NC/PLC variables" window.
2. Press the ">>" softkey. 
3. Press the "Save screen" softkey.  The "Save screen: Select archiving" window opens.
4. Position the cursor on the template folder for variable screen forms in which your actual screen form should be saved and press the "OK" softkey.  The "Save screen: Name" window opens.
5. Enter the name for the file and press the "OK" softkey.  A message in the status line informs you that the screen form was saved in the specified folder.
If a file with the same name already exists, they you will receive a prompt.
6. Press the "Load screen" softkey.  The "Load screen" window opens and displays the sample folder for the variable screen forms.
7. Select the desired file and press the "OK" softkey. You return to the variable view. The list of all of the predefined NC and PLC variables is displayed.

15.7 Version

15.7.1 Displaying version data

The following components with the associated version data are specified in the "Version data" window:

- System software
- PLC basic program
- PLC user program
- System expansions
- OEM applications
- Hardware

Information is provided in the "Nominal version" column as to whether the versions of the components deviate from the version supplied on the CompactFlash Card.



The version displayed in the "Actual version" column matches the version of the CF card.



The version displayed in the "Actual version" column does not match the version of the CF card.

You may save the version data. Version data saved as text files can be further processed as required or sent to the hotline in the event of an error.

Procedure



1. Select the "Diagnostics" operating area.



2. Press the "Version" softkey.
The "Version Data" window appears.
Data of the available components is displayed.



3. Select the component for which you would like more information.



4. Press the "Details" softkey, in order to receive more exact information on the components displayed.

15.7.2 Save information

All the machine-specific information of the control is combined in a configuration via the user interface. You then have the option of saving the machine-specific information on the drives that have been set up.

Procedure



1. Select the "Diagnostics" operating area.



2. Press the "Version" softkey.
It takes some time to call the version display. While the version data is being determined a progress message box and the appropriate text are displayed in the dialog line.



3. Press the "Save" softkey.
The "Save version information: Select Archive" window opens. The following storage locations are offered depending on the configuration:

- Local drive
- Network drives
- USB
- Version data (archive: Data tree in the "HMI data" directory)



4. Then press the "New directory" softkey if you wish to create your own directory.



5. Press the "OK" softkey. The directory is created.



6. Press the "OK" softkey again to confirm the storage location.

The "Save version information: Name" window opens.

7. Specify the desired settings.

- "Name:" input field
the file name is pre-assigned with <Machine name/no.>+<CF-card number>. "_config.xml" or "_version.txt" is automatically attached to the file names.
- "Comment:" input field
You can enter a comment that is stored with the configuration data.
- Version data (.TXT)
Activate the checkbox if you wish to output the pure version data in the text format.
- Configuration data (.XML)
Activate the checkbox if you wish to output the configuration data in the XML format.
The configuration file contains the data you entered under Machine identity, the license requirements, the version information and the logbook entries.

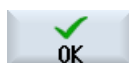

8. Press the "OK" softkey to start the data transfer.

15.8 Logbook

The logbook provides you with the machine history in an electronic form.

If service is carried out on the machine, this can be electronically saved. This means that it is possible to obtain a picture about the "History" of the control and to optimize service.

Editing the logbook

You can edit the following information:

- Editing information on the machine identity
 - Machine name/No.
 - Machine type
 - Address data
- Make logbook entries (e.g. "filter replaced")
- Deleting logbook entries

Note

Deleting logbook entries

Up to the 2nd commissioning, you have the option to delete all of the entered data up to the time of the first commissioning.

Output of the logbook

You have the possibility of exporting the logbook by generating a file using the "Save version" function in which the logbook is contained as section.

See also

Save information (Page 836)

15.8.1 Displaying and editing the logbook

Procedure



1. Select the "Diagnostics" operating area.



2. Press the "Version" softkey.



3. Press the "Logbook" softkey.
The "Machine logbook" window opens.

Editing end customer data



4. You have the option of changing the address data of the end customer using the "Change" softkey.

- OR -



Using the "Clear" softkey, you can delete all logbook entries.



All entries, except the date of the first commissioning, are deleted. Softkey "Clear" is deactivated.

Note

Deleting logbook entries

As soon as the 2nd commissioning has been completed, the "Clear" softkey to delete the logbook data is no longer available.

15.8.2 Making a logbook entry

Using the "New logbook entry" window to make a new entry into the logbook.

Enter your name, company and department and a brief description of the measure taken or a description of the fault.

Note

Setting line breaks

If you wish to make line breaks in the "Fault diagnostics/measure" field, use the key combination <ALT> + <INPUT>.

The date and entry number are automatically added.

Sorting the entries

The logbook entries are displayed numbered in the "machine logbook" window.

More recent entries are always added at the top in the display.

Procedure



1. The logbook is opened.
2. Press the "New entry" softkey.

The "New logbook entry" window opens.



3. Enter the required data and press the "OK" softkey.



You return to the "Machine logbook" window and the entry is displayed below the machine identity data.

Note**Deleting logbook entries**



Up to the completion of the 2nd commissioning, you have the option to delete the logbook entries up to the time of the first commissioning using the "Clear" softkey.

Searching for a logbook entry

You have the option for searching for specific entries using the search function.

1. The "Machine logbook" window is opened.
2. Press the "Find" softkey.

3. Enter the desired term in the search form. You can make a search according to date/time, company name/department or according to fault diagnostics/measure.
The cursor is positioned on the first entry that corresponds to the search term.
4. Press the "Continue search" softkey if the entry found is not the one that you are looking for.

Additional search option

-  Press the "Go to Beginning" softkey to start the search at the latest entry.
-  Press the "Go to End" softkey to start the search at the oldest entry.

15.9 Remote diagnostics

15.9.1 Setting remote access

You can influence the remote access to your control in the "Remote diagnostics (RCS)" window.

You set the rights for all remote operating types in this window. The selected rights are defined from the PLC and using the setting at the HMI.

The HMI can restrict the rights specified from the PLC, but however, cannot extend the rights beyond the PLC rights.

If the settings made permit access from outside, then this is still dependent on a manual or automatic confirmation.

Rights for remote access

The "Specified by PLC" field shows the access rights for remote access or remote monitoring specified from the PLC.



Machine manufacturer

Please refer to the machine manufacturer's instructions.

In the "Selected in the HMI" selection box, you have the possibility of setting rights for remote control:

- Do not permit remote access
- Permit remote monitoring
- Permit remote control

Depending on the combination of the settings in the HMI and in the PLC the valid status as to whether access is permitted or not is shown in the "Resulting from this" line.

Settings for the confirmation dialog box

If the settings made for "Specified from the PLC" and "Selected in the HMI" permit access from outside, then this is however, still dependent on either a manual or automatic confirmation.

As soon as a remote access is permitted, at all of the active operating stations, a query dialog box is displayed for the operator at the active operating station to either confirm or reject an access.

For the case that there is no local operation, then the control behavior can be set for this particular scenario. You define how long this window is displayed and whether, after the confirmation has expired, the remote access is automatically rejected or accepted.

Display of the state



Remote monitoring active



Remote control active

If remote access is active, using these icons you will be informed in the status line as to whether a remote access is presently active or whether only monitoring is permitted.

Procedure



1. Select the "Diagnostics" operating area.



2. Press the "Remote diag." softkey.
The "Remote diagnostics (RCS)" window is opened.



3. Press the "Change" softkey.
The "Selected in the HMI" is activated.



4. If you desire remote control, select the entry "Permit remote control".

In order that remote control is possible, the entry "Allow remote operation" must be specified in the fields "Specified by PLC" and "Selected in HMI".

5. Enter new values in the group "Behavior for remote access confirmation" if you wish to change the behavior for confirming remote access.



6. Press the "OK" softkey.
The settings are accepted and saved.

References

A description of the configuration options can be found in the following reference:
SINUMERIK Operate Commissioning Manual

15.9.2 Permit modem

You can permit remote access to your control via a teleservice adapter IE connected at X127.



Machine manufacturer

Please refer to the machine manufacturer's instructions.



Software option

You need the "Access MyMachine /P2P" option to display the "Allow modem" softkey.

Procedure



1. The "Remote diagnostics (RCS)" window is opened.
2. Press the "Allow modem" softkey.
Access to the control via modem is enabled so that a connection is established.
3. To block access again, press the "Allow modem" softkey again.

15.9.3 Request remote diagnostics

Using the "Request remote diagnostics" softkey, from your control you have the option of actively requesting remote diagnostics with your machinery construction OEM.

Access via modem must be enabled if the access is to be made possible via a modem.



Machine manufacturer

Please refer to the machine manufacturer's instructions.

When requesting remote diagnostics, you obtain a window with the corresponding pre-assigned data and values of the ping service. If required, you can ask your machine manufacturer for this data.

Data	Meaning
IP address	IP address of the remote PC
Port	Standard port that is intended for remote diagnostics
Send duration	Duration of the request in minutes
Send interval	Cycle in which the message is sent to the remote PC in seconds
Ping send data	Message for the remote PC

Procedure



1. The "Remote diagnostics (RCS)" window is opened.
2. Press the "Request remote diagnostics" softkey.
The "Request remote diagnostics" window is displayed.
3. Press the "Change" softkey if you would like to edit the values.
4. Press the "OK" softkey.
The request is sent to the remote PC.

References

SINUMERIK Operate Commissioning Manual

15.9.4 Exit remote diagnostics

Procedure



1. The "Remote diagnostics (RCS)" is opened and it is possible that remote monitoring or remote access is active.
2. Block the modem access if access via modem is to be blocked.
- OR -
In the "Remote Diagnostics (RCS)" window, reset the access rights to "Permit no remote access".

Working with Manual Machine

16.1 Manual Machine

"Manual Machine" offers a comprehensive spectrum of functions for manual mode. You can carry out all the important machining processes without writing a program.



Software options
You require the "ShopMill/ShopTurn" option for working with "Manual Machine"

Machining

Machining before the center of rotation is typical.



Machine manufacturer

Please refer to the machine manufacturer's specifications.

Main screen

After power-up of the control, the basic screen appears for "Manual Machine".

The screenshot shows the Siemens Manual Machine control interface. At the top, there is a status bar with a date and time (04/03/14 12:51 PM) and the 'SIEMENS' logo. Below this, the 'JOG' mode is indicated. The main display area is divided into several sections:

- Machine Status:** Shows 'CHAN1 Reset' and 'Machine' information.
- Position [mm]:** A table showing coordinates for X1, Y1, Z1, B1, and Z3, all set to 0.000.
- T, F, S Parameters:** Shows tool (T), feed rate (F), and spindle speed (S4) settings.
- WSP:** Workpiece coordinate system selection.
- Jog Control:** A central pad with directional arrows (-X, +X, -Z, +Z) and a green center button.
- Machine Parameters:** A list of parameters including β , Y, F (200.000 mm/min), S4 (1700.000 rpm), S1 (2000.000 rpm), and $\alpha 1$ (0.000°).
- Other M function:** A field for entering other machine functions.
- Bottom Bar:** A row of icons for 'Meas. tool', 'Set W0', 'Strght Circle', 'Drilling', 'Turning', 'Cont. turn.', 'Milling', and 'Simulation'.

Machining options

You have the following options for machining the workpieces:

- Manual mode
- Single-cycle machining

16.2 Measuring the tool

All the options of the manual and automatic measurement are available to determine the tool offset data (see also Section "Measuring the tool (Page 100)").

Procedure



1. "Manual Machine" is active.
2. Press the "Meas. tool" softkey.
3. Select the the required measuring function via the vertical softkey bar and press the appropriate softkey.

16.3 Setting the zero offset

Directly select the work offset in the "Parameter" operating area in the work offset list.



Machine manufacturer

Please refer to the machine manufacturer's specifications.

Procedure

1. "Manual Machine" is active.
2. Select the "Parameter" operating area.
2. Press the "Work offset" and "G54...599" softkeys.



The "Work Offset G54...599" window opens.



3. Position the cursor on the desired work offset and press the softkey "WO selection"



Now return to the basic screen and enter the selected work offset in the "Work offset" field.

See also

Setting the zero offset (Page 98)

16.4 Set limit stop

You can limit the traversing range of the axes.

To do this, enter the values for the respective axes. The values refer to the workpiece coordinate system. The limits can be switched on and off individually.

Activated, i.e. active set limits, are indicated by a bar next to the wind rose in the direction graphic.

When a limit is reached, an alarm appears which disappears again when the axis is moved away from the limit.

Note

Entered and activated limit stops remain active after switching from JOG mode to MDA or AUTO mode.



Machine manufacturer

Please refer to the machine manufacturer's specifications.

Procedure



1. "Manual Machine" is active
2. Press the "Limit stops" softkey.
The "Limit Stops" window opens.
3. Enter the desired position of the limit stop for each axis.
- OR -
Press the "Set limit stop" softkey to enter the current position of an axis.
4. In the field next to the position specification select the entry "On" to activate the desired limit stop.
The bar is displayed next to the wind rose.
5. Press the "Back" softkey to return to the basic screen.
The active limit stops are also displayed here with bars.

16.5 Simple workpiece machining

In "Manual Machine", you machine workpieces directly without creating a program.

Functions

The following functions are available to you for machining in manual mode:

- Axis movements
- Taper turning
- Straight (face and longitudinal turning) and circle



Note

Tool, spindle speed and direction of spindle rotation are activated with <CYCLE START>. A change in feedrate immediately becomes active.

16.5.1 Traversing axes

For preparatory actions and simple traversing movements, input the parameters directly into the "Manual Machine" input fields of the basic screen.

Tool selection

1. "Manual Machine" is active.
2. Select the desired tool in "T".

3. Enter the feedrate (F) and the spindle speed (S).
4. Select the direction of spindle rotation (e.g. clockwise direction of rotation):

- OR -
Set the direction of rotation via the machine control panel.
5. Press the <CYCLE START> key.

The spindle starts immediately after the tool is selected.

Note:

Please refer to the machine manufacturer's specifications.

Machining

6. Select the axis to be traversed on the machine control panel.

...



7. Press the <+> or <-> key on the machine control panel.

...

- OR -

Select the direction with the aid of the cross-switching lever.

The axes are moved at the set machining feedrate.

Note:

Please refer to the machine manufacturer's specifications.

The active direction is graphically displayed in the basic screen by means of the wind rose.

16.5.2 Taper turning

The basic effective direction can be selected via the axis direction keys or via the cross-switching lever. In addition, a taper angle (α_1) can also be entered.

Procedure









1. "Manual Machine" is active.
2. Press the "Taper turning" softkey.
3. Select the tool, spindle, and spindle direction and specify the machining feedrate.
4. Enter the desired angle α_1 .

Note

Selecting/deselecting the taper turning and changing the angle α_1 is only possible in the reset state.

Parameter	Description	Unit
T	Tool name	
D	Cutting edge number	
ST		
F	Feedrate	mm/min mm/rev
S / V	Spindle speed or constant cutting rate	rev/min m/min

Parameter	Description	Unit
Spindle M function 	 Spindle off: Spindle is stopped	
	 CCW rotation: Spindle rotates counterclockwise	
	 CW rotation: Spindle rotates clockwise	
Gear stage 	Specification of the gear stage (auto, I - V)	
$\alpha 1$	Rotation of the coordinate system.	Degrees
Other M function	Input of machine functions Refer to the machine manufacturer's table for the correlation between the meaning and number of the function.	
Machining plane 	Selection of the machining plane (G17(XY), G18 (ZX), G19 (YZ))	

16.5.3 Straight and circular machining

16.5.3.1 Straight turning

Use this function for simple, straight machining (e.g. face or longitudinal turning).

Procedure



1. "Manual Machine" is active.
2. Press the "Straight circle" softkey.
3. Select the desired straight machining and press the "All axes" softkey
 - OR -
 Press the softkey "Straight X α "
 - OR -
 Press the softkey "Straight Z α "
4. Specify the desired value for the feedrate F.
 - OR -
 Press the "Rapid traverse" softkey.
 The rapid traverse is displayed in field "F".
5. Enter the target position and, if required, the angle (α) for the axis or axes to be traversed.



Using the "Graphic view" softkey, you can toggle between the help screen and the graphic view in the screen.

Parameter	Description	Unit
F 	Feedrate	mm/min mm/rev
	All axes	
X	Target position in the X direction (abs or inc)	mm
Z	Target position in the Z direction (abs or inc)	mm
Y	Target position in the Y direction (abs or inc)	mm
C	Target position of C axis of main spindle (abs or inc)	mm
Z2	Target position of an added axis, if it exists (abs or inc)	mm
	Straight X α	
X	Target position in the X direction (abs or inc)	mm
α	Angle of the straight line to the X axis	Degrees
	Straight Z α	
Z	Target position in the Z direction (abs or inc)	mm
α	Angle of the straight line to the Z axis	Degrees

16.5.3.2 Circular turning

You can use this function for a simple circular machining.

Procedure









1. "Manual Machine" is active.
2. Press the "Straight circle" softkey.
3. Press the "Circle" softkey.
4. Specify the desired value for the feedrate F.
5. Select the desired circle input (e.g. "End point + radius") and the direction of rotation.
6. Enter the target position as well as the circle center point or radius.



Using the "Graphic view" softkey, you can toggle between the help screen and the graphic view in the screen.

Parameters

Parameter	Description	Unit
F 	Feedrate	mm/min mm/rev
Circle input 	<ul style="list-style-type: none"> • End point + center point • End point + radius 	
Direction of rotation 	 Clockwise direction of rotation  Counter-clockwise direction of rotation	
X 	Target position in the X direction (abs and inc)	mm
Z 	Target position in the Z direction (abs and inc)	mm
I	Circle center point I (inc) - only if circle input via end point and center point	mm
K	Circle center point K (inc) - only if circle input via end point and center point Note: Incremental dimensions: The sign is also evaluated.	mm
R	Radius - only if circle input via end point and radius	mm

16.6 More complex machining

The following functions are available to you for comprehensive machining in manual mode:

- Drilling (center drilling, centering, drilling, reaming, deep-drilling, threads, positions)
- Turning (stock removal, groove, undercut, threads, tapping)
- Milling (face milling, pocket, spigot, multiple edge, groove, thread milling, engraving)
- Contour turning (contour, stock removal, grooving, plunge turning)

Note

Deselecting technological functions

Press the "Back" softkey to return to the main screen from the list of technological functions.

General sequence

For more complex machining processes, proceed in the following order:

- Select the desired function via the corresponding softkey.
- Select the tool and enter the desired values in the parameter screen.
- Press the "Accept" softkey to save the values.
The input screen form closes.
A line with the specified parameters is displayed on the basic screen.
- Press the <CYCLE START> key.
The selected cycle is started.
- OR -
- Press the "Cancel" softkey to return to the basic screen.

Note

Note

You can return to the parameter screen form at any time to check and correct the inputs.

Press the <"Cursor right"> key to jump back to the input screen form.

Drilling a position pattern

You can drill a position pattern:

- First select the desired function (e.g. "Centering") via the softkey in "Drilling".
- Select the appropriate tool, enter the desired values in the parameter screen and press the "Accept" softkey to confirm the technology block.
The input screen is closed and the line with the technology data is displayed in the main screen.
- Press the "Positions" softkey and select the desired position pattern (e.g. any positions) via softkey, enter the desired values in the parameter screen form press the "Accept" softkey.
The input screen is closed and the technology and positioning blocks are displayed in brackets.

Note

You only have the option of creating a machining operation and a position pattern one after the other.

Note

If you enter the positions first, only the drilling cycles for driven tools are offered after creating the positioning block.

Approach and retraction

When machining the workpiece, you traverse from the current position to the machining start point. After the machining process, the tool is returned along a direct path to the starting point.

16.6.1 Drilling with Manual Machine

Functions (cycles)

The same range of technological functions (cycles) is available as in automatic mode for drilling on the face or peripheral surface of a workpiece:



Machine manufacturer

Please refer to the machine manufacturer's specifications.

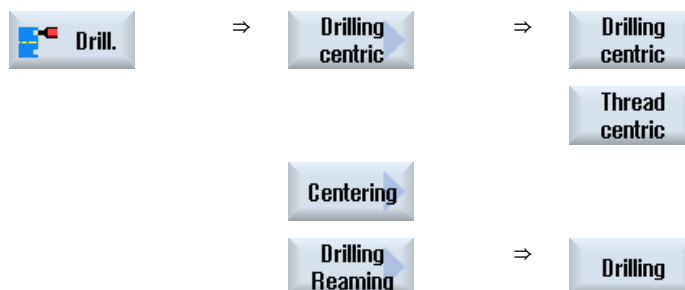

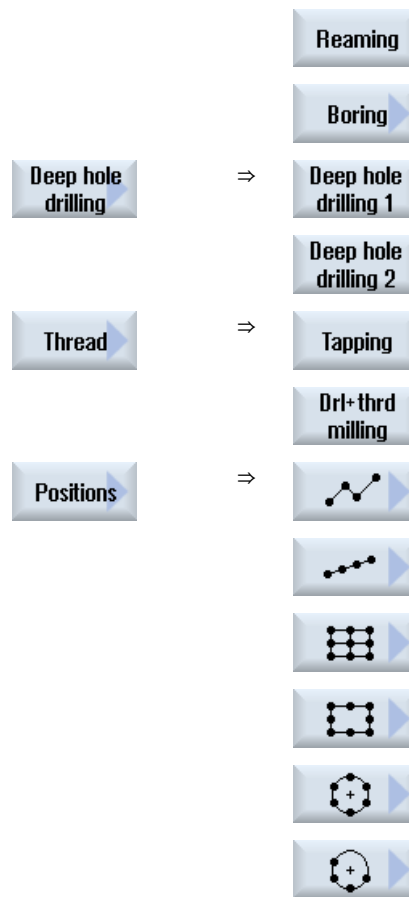

Parameter

The parameters of the input screen forms correspond to the parameters under Automatic (see Section "Drilling (Page 339)").

16.6.2 Turning with manual machine

Functions (cycles)

The same range of technological functions (cycles) is available for turning as in the automatic mode:



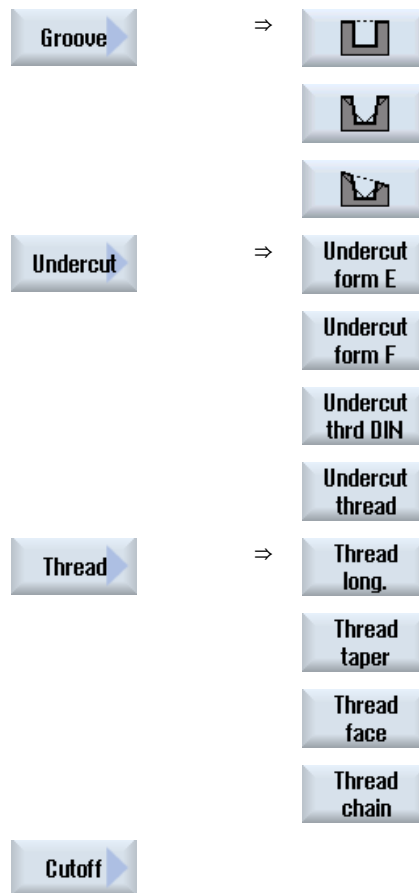

Parameter

The parameters of the input screen forms correspond to the parameters under Automatic (see Section "Rotate (Page 400)").

Thread cutting

In addition to the functions that are made available by "thread-cutting" under Automatic, you can insert idle cuts during the machining process under "Manual Machine."

You can interrupt the infeed of the cutting depth during the machining process by inserting idle cuts, in order to smooth the flanks for example.



You can insert idle cuts using the "Idle cut" softkey. This softkey is only active during machining.

Thread re-machining

You can re-machine existing threads, when repairing previously cut threads for example or as the result of changes that arise from re-measuring (see Section "Thread synchronizing (Page 146)").

If you want to rework some threads, input the initial plunge depth D0 (inc.). This is the depth that was reached during a previous machining.

Note

By inputting the plunge depth, you avoid unnecessary idle cuts when reworking the threads.

B axis

16.6.3 Contour turning with Manual machine

For contour turning of simple geometric shapes, the same range of technological functions (cycles) as in automatic mode is available.



Machine manufacturer

Please refer to the machine manufacturer's specifications.

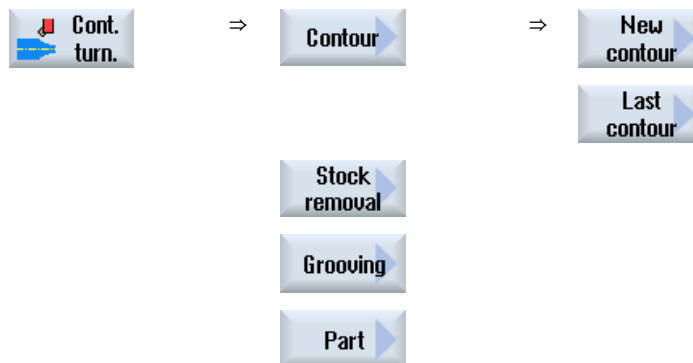

Parameters

The parameters of the input screen forms correspond to the parameters under Automatic (see Section Contour turning (Page 436)).

Last contour



If you have created a contour since the startup of the machine, the "Last contour" softkey is available. You then have the option to reopen the input screen with the last contour you entered in "Manual machine" for editing.

16.6.4 Milling with Manual Machine

The same range of technological functions (cycles) is available as in automatic mode for the milling of simple geometric shapes.



Machine manufacturer

Please refer to the machine manufacturer's specifications.

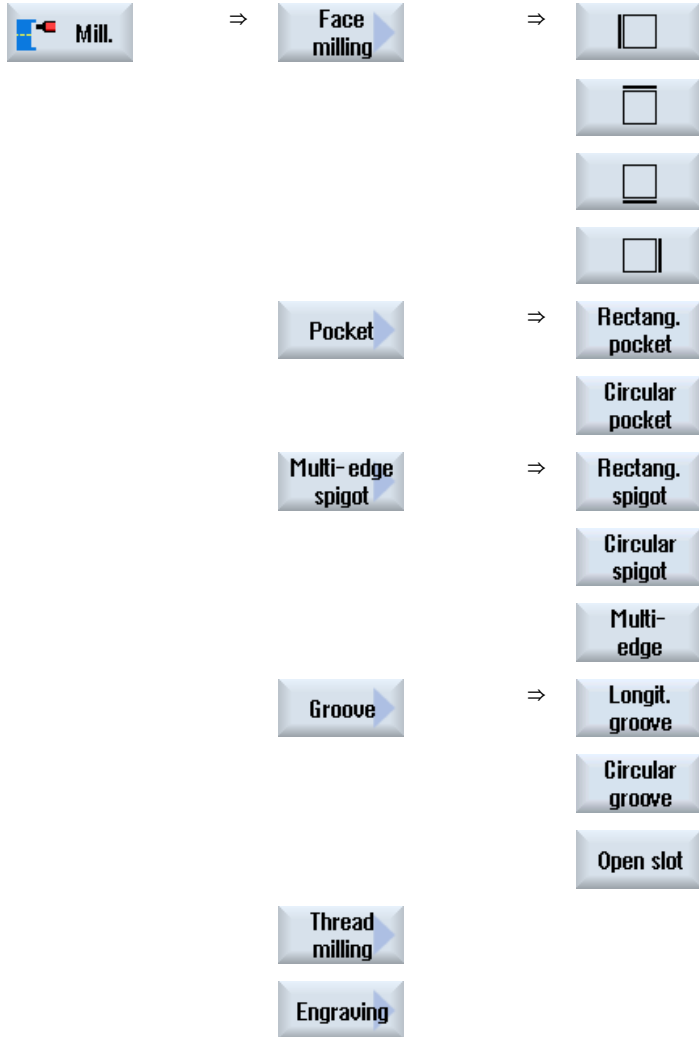

Parameters

The parameters of the input screen forms correspond to the parameters under Automatic (see Section "Milling (Page 478)").

16.7 Simulation and simultaneous recording

For more complex machining processes, you can check the result of your inputs with the aid of the simulation, without having to traverse the axes (see Section "Simulating machining (Page 231)"). The execution of the work steps is graphically displayed on the screen during this period.



Software option

You require the option "Simultaneous recording ShopTurn (real-time simulation)" for the simultaneous recording of the work steps.

Note

In "Manual Machine", you can simulate a work step with an already opened and filled out parameter screen form.

Setting up a blank shape

For the graphical display, a pre-defined blank shape is used. Just the same as under simultaneous recording, in automatic and simulation you can change the blank as required (see Section "Blank display (Page 245)").

Working with a B axis (only 840D sl)

17.1 Lathes with B axis

With an additional B axis, you have the option of aligning milling machines and lathes.

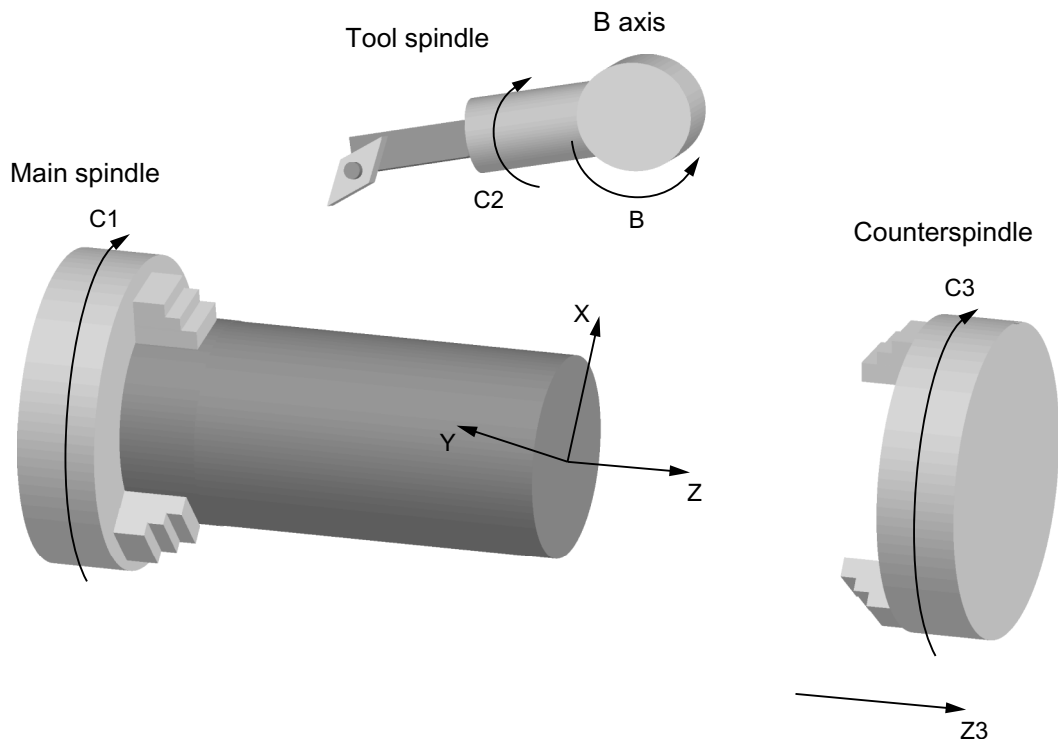

The initial setting in which all tools must be measured is $B=0$.

When turning, you can align the tool for special machining operations using the B axis and C axis of the tool spindle.

When milling, you can swivel the workpiece using the B and C axis of the main or counterspindle so that you can mill and drill on inclined surfaces.

The B axis is also used for aligning tools for face and peripheral surface machining.

Alignment angles β and γ

Alignment angles β and γ are required for turning with tool alignment.

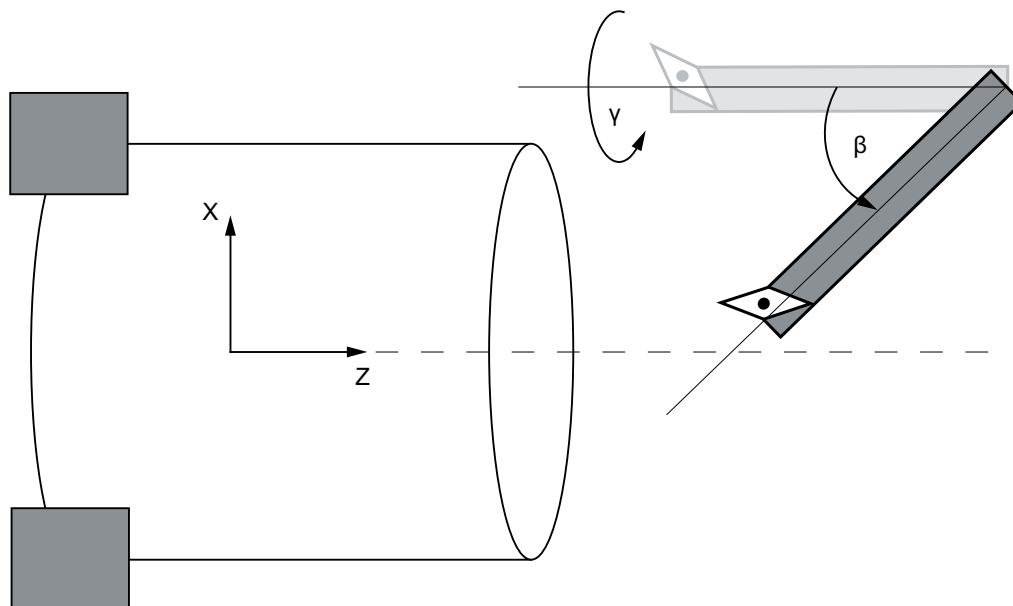

β : Rotation around the Y axis (with the B axis)

γ : Rotation around the Z axis (with the tool spindle)

Turning

Alignment angles allow you to perform a wide range of different turning operations (for example, internal and external longitudinal machining, surface machining with a main spindle and counterspindle, residual material) without changing the tool.

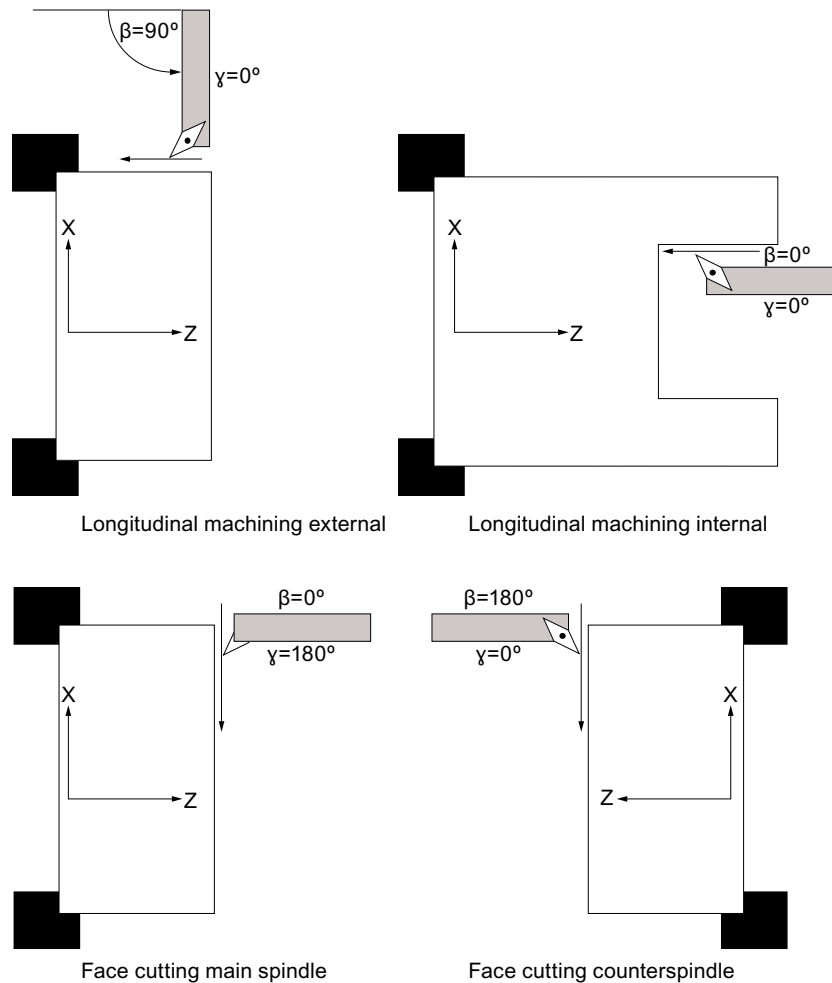

Display of the B axis

The B axis is displayed in the following windows:



- Axis position display in actual value window
- In the "Positioning" window to position axes in manual operation
- You can display the B axis in the zero offset lists using the "Zero offset" softkey and you can also define the offset.

17.2 Tool alignment for turning

The input fields for the β and γ angles for aligning the tool are available in the tool screen and in all turning screens.

β angle

In the entry field " β " you have the possibility of selecting the main alignment of the tool:

-  : $\beta = 0^\circ$
-  : $\beta = 90^\circ$
- Empty : The required angle can be freely entered

Programming when machining with a counter-spindle

When machining on the counter-spindle, it is programmed in exactly the same way as the main spindle.

The direction display of the arrows depends on the settings.



Machine manufacturer

Please refer to the machine manufacturer's specifications.

γ angle

In the entry field " γ " you have the possibility of selecting the main alignment of the tool:

- 0°
- 180°
- or -
- Free entry field to enter the required angle



Machine manufacturer

Please refer to the machine manufacturer's specifications.

17.3 Milling with a B axis

No special entries are required for face machining and peripheral surface machining.

Face machining

Milling at the face (G17) is realized on the main spindle in the B axis position $B = 0^\circ$. If you are machining at the face (G17) of the counterspindle, then this corresponds to the opposite setting of the B axis position $B = 180^\circ$.

Peripheral surface machining

Milling on the peripheral surface is always realized in the B axis position, $B = 90^\circ$ (main and counterspindle).

Machining on an inclined surface

You can define inclined surfaces in a swivel mask.

You can enter the rotation of the planes around the geometry axes (X, Y, Z) of the tool coordinate system as described in the workpiece drawing. The rotation of the Work in the program is then automatically converted to a rotation for the relevant B and C axis of the machine during machining.

The swivel axes are always rotated to place the tool axis perpendicular to the machining axis for machining. During machining, the rotary axes are stationary.

The coordinate system is adapted to the surface to be machined irrespective of the required rotary axis positions.

17.4 Swiveling

General sequence

- Swivel the coordinate system into the plane to be machined via the swivel screen.
- Machining with the setting "Face B".
- If another machining type follows, swiveling is automatically deselected.

The swiveled coordinates are maintained in the reset state and after Power On. So you can still move out of an inclined hole, for example, with retraction in the +Z direction.



Machine manufacturer



Please refer to the machine manufacturer's specifications.

Swiveling is executed one axis at a time. In the case of axis-by-axis swiveling, the coordinate system is rotated around each axis in turn, with each rotation starting from the previous rotation. The axis sequence can be freely selected.

Procedure



1. The "Spigot Res. Mat." input window opens if you press the "Various" softkey.
2. Press the "Swivel plane" softkey.
3. Press the "Initial position" softkey if you wish to reestablish the basic setting, i.e. you wish to set the values back to 0.
This is done, for example, to swivel the coordinate system back to its original orientation.

Parameter	Description	Unit
T	Tool identifier	
RP	Retraction plane for face B	mm
C0	Positioning angle for machining surface	Degrees
X0	Reference point for rotation	mm
Y0	Reference point for rotation	mm
Z0	Reference point for rotation	mm
Swivel mode 	<ul style="list-style-type: none"> • axis-by-axis: Swivel coordinate system axis-by-axis • Solid angle: Swivel via solid angle • Proj. angle: Swiveling via projection angle • Direct: Position rotary axes directly 	
Axis sequence 	Sequence of the axes which are rotated around - (only for axis-by-axis swivel mode) XYZ or XZY or YXZ or YZX or ZXY or ZYX	

Parameter	Description	Unit
X	Axis angle	Degrees
Y	Axis angle	Degrees
Z	Axis angle	Degrees
X1	New zero point of rotated surface	mm
Y1	New zero point of rotated surface	mm
Z1	New zero point of rotated surface	mm

Note

Other additive transformations can be added to the offsets before (X0, Y0, Z0) or after (X1, Y1, Z1) swiveling (see Section "Work offsets").

17.5 Approach/retraction

If you want to optimize approach/return for swiveling with the B axis, you can create a special cycle that ignores the automatic approach/retraction strategy.

You can insert the approach/retraction cycle between any machining step program blocks, but not within linked program blocks.

Sequence

The starting point for the approach/retraction cycle is the safety clearance approached after the last machining operation.

If you want to perform a tool change, you can move the tool through a total of three positions (P1 to P3) to the tool change point and through a maximum of three additional positions (P4 to P6) to the next starting point.

The 1st, 3rd, 4th and 6th positions move the linear axes, while the 2nd and 5th positions move the rotary axes.

If no tool change is needed you can generate no more than six motion blocks.

The numbers (1 - 6) represent the processing sequence.

Note

Programming additional positions

If three or six positions are not sufficient for the approach/retraction, you can call the cycle several times in succession to program further positions.

NOTICE

Risk of collision

Note that the tool will move from the last position programmed in the approach/retraction cycle directly to the starting point for the next machining operation.

Parameter	Description	Unit
F1	Feedrate to approach the first position Alternatively, rapid traverse	mm/min
X1	1. position (inc or Ø abs)	mm
Z1	1. position (inc or Ø abs)	mm
Y1	Retraction to safety clearance	mm
β2	Beta angle for 1st swivel movement	Degrees
γ2	Gamma angle for 1st swivel movement	Degrees
Tracking	The position of the tool tip is maintained during swiveling. Please refer to the machine manufacturer's instructions.	
F3	Feedrate to approach the third position Alternatively, rapid traverse	mm/min

Parameter	Description	Unit
X3	3. position (inc or Ø abs)	mm
Z3	3. position (inc or Ø abs)	mm
Tool change	<ul style="list-style-type: none"> • TlChngPt: Approach the tool change point from the last programmed position and carry out a tool change • Direct: Tool is not changed at the tool change position, but at the last programmed position • No: Tool is not changed 	
T	Tool name (not for tool change "no")	
D	Cutting edge number (not for tool change "no")	
F4	Feedrate for approach to the fourth position Alternatively, rapid traverse	mm/min
X4	4. position (inc or Ø abs)	mm
Z4	4. position (inc or Ø abs)	mm
β5	Beta angle for 2nd swivel movement	Degrees
γ5	Gamma angle for 2nd swivel movement	Degrees
Tracking	The position of the tool tip is maintained during swiveling. Please refer to the machine manufacturer's instructions.	
F6	Feedrate to approach the sixth position Alternatively, rapid traverse	mm/min
X6	6. position (inc or Ø abs)	mm
Z6	6. position (inc or Ø abs)	mm
Y6	Retraction to safety clearance	mm

17.6 Position pattern

In drilling and milling operations with face B, position patterns "full circle/pitch circle" provide the following options for machining on inclined surfaces

- with swivel plane
- with C axis

Procedure



1. Press the "Drilling" softkey.



2. Press the "Positions" and "Full circle/pitch circle" softkeys.



Parameter	Description	Unit
	Face B on the swivel plane	
Z0	Z coordinate of the reference point (abs)	mm
X0	X coordinate of the reference point (abs)	mm
Y0	Y coordinate of the reference point (abs)	mm
$\alpha 0$	Starting angle: Angle of 1st hole with reference to X axis. Positive angle: Full circle is rotated counterclockwise. Negative angle: Full circle is rotated in clockwise direction.	Degrees
$\alpha 1$	Indexing angle: After the first hole has been drilled, all additional positions are approached at this angle (only for pitch circle). Positive angle: Additional positions are rotated in counterclockwise direction. Negative angle: Additional positions are rotated in clockwise direction.	Degrees
R	Radius of full circle	mm
N	Number of positions on circle	
Positioning	Straight line: Next position is approached linearly in rapid traverse. Circular: Next position is approached along a circular path at the feedrate defined in the machine data.	mm
	Face B - wit C axis	
Z0	Z coordinate of the reference point (abs)	mm
X0	X coordinate of the reference point (abs)	mm
Y0	Y coordinate of the reference point (abs)	mm
$\alpha 0$	Starting angle: Angle of 1st hole with reference to C axis. Positive angle: Full circle is rotated counterclockwise. Negative angle: Full circle is rotated in clockwise direction.	Degrees

Parameter	Description	Unit
α_1	Indexing angle: After the first hole has been drilled, all additional positions are approached at this angle (only for pitch circle). Positive angle: Additional positions are rotated in counterclockwise direction. Negative angle: Additional positions are rotated in clockwise direction.	Degrees
N	Number of positions on circle	

17.7 Tool selection for the manual mode

For the preparatory actions in the manual mode, tool selection and spindle control are both performed centrally in the T, S, M window.

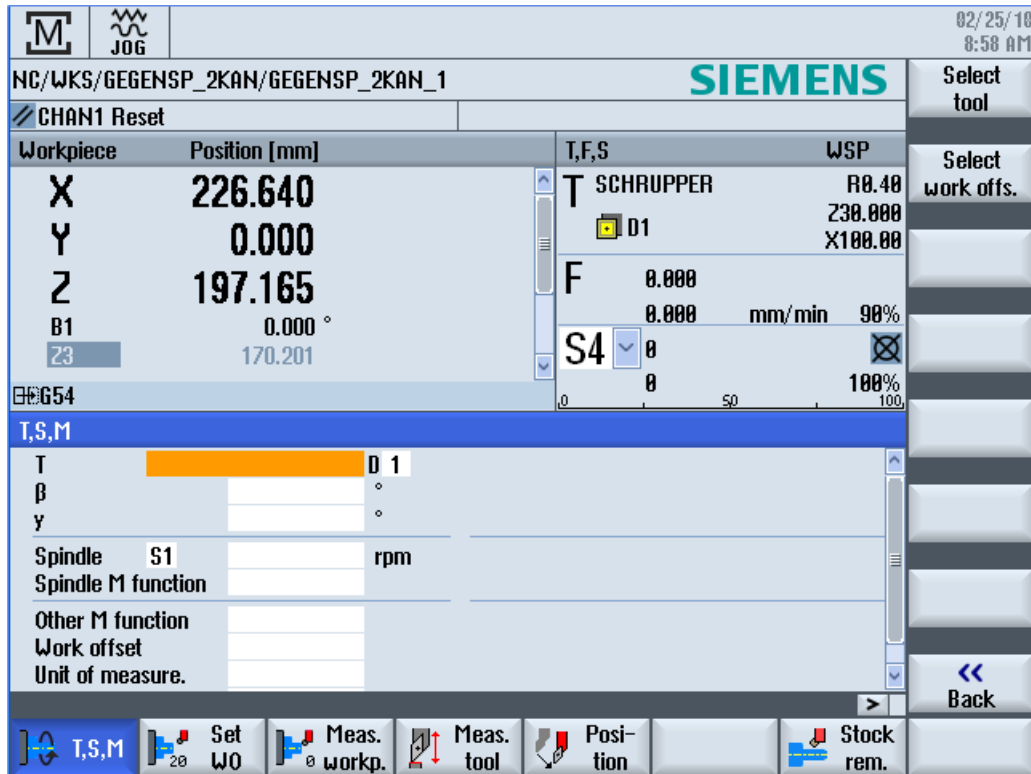

Figure 17-1 TSM window for the B and C axis

Procedure



Aligning the milling and turning tool with β angle:

Press the <SELECT> key and select

- 0° or
- 90° or
- Value entry box to freely enter the angle.

Aligning the turning tool with γ angle:

Press the <SELECT> key and select

- 0°
- 180°
- Value entry box to freely enter the angle.



See also

Selecting a tool and spindle (Page 134)

17.8 Measuring a tool with the B axis

When measuring manually, traverse the tool manually to a known reference point in order to determine the tool dimensions in the X and Z directions. The control system then calculates the tool offset data from the position of the tool carrier reference point and the reference point.

To determine the tool dimensions, the orientation, i.e. the β angle, must be specified. The γ angle input box is also provided for turning tools.

Reference point

The workpiece edge is used as the reference point when measuring length X and length Z. The chuck of the main or counterspindle can also be used when measuring in the Z direction. Specify the position of the workpiece edge during the measurement.

β angle

In order to measure milling and turning tools, you can select the two main settings $\beta = 0^\circ$ and $\beta = 90^\circ$ and a value input field.

γ angle

In order to measure turning tools, you can select the γ angle 0° and 180° .

Procedure



1. Select "JOG" mode in the "Machine" operating area.



2. Execute the tool change and alignment in the T, S, M window before performing the measurement.



3. Press the "Meas. tool" softkey.

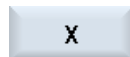

4. Press the "X" or "Z" softkey, depending on which tool length you want to measure.



5. Scratch the required edge using the tool.

**Save
position**

If you do not wish to keep the tool at the workpiece edge, then press the "Save position" softkey.

The tool position is saved and the tool can be retracted from the workpiece. For instance, this can be practical if the workpiece diameter still has to be subsequently measured.

If the tool can remain at the workpiece edge, then after scratching you can directly continue with step 7.

6. Enter the position of the workpiece edge in X0 or Z0.

If no value is entered for X0 or Z0, the value is taken from the actual value display.

**Set
length**

7. Press the "Set length" softkey.

The tool length is calculated automatically and entered in the tool list. Whereby the cutting edge position and tool radius or diameter are automatically taken into consideration as well.

Note

Tool measurement is only possible with an active tool.

See also

T,S,M window (Page 134)

Measuring a tool manually (Page 100)

Working with two tool carriers

With SINUMERIK Operate, you can work at a lathe with two tool holders, both of which are mounted on an X axis. The tool holders may be revolvers, multifix, or a combination of both.

The main machining is performed in the negative X axis direction. As both tool holders are mounted on the same axis it is only possible to machine with one tool.

The workpiece is always located between the two tool holders. The tool lengths of all tools, i.e. of both tool holders, have the same reference point, which is usually on tool holder 1. That is why the tool lengths of the tools of the second tool holder are always longer than those of the tools on the first tool holder.

18.1 Programming with two tool holders

You always program in the basic coordinate system (workpiece coordinate system of the first tool holder). You do not have to take into account in which tool holder the tool is inserted.

Tool on the second tool holder

If a tool on the second tool holder is selected, the X and Y axes are mirrored and the main spindle and counterspindle are offset (rotated) through 180°.

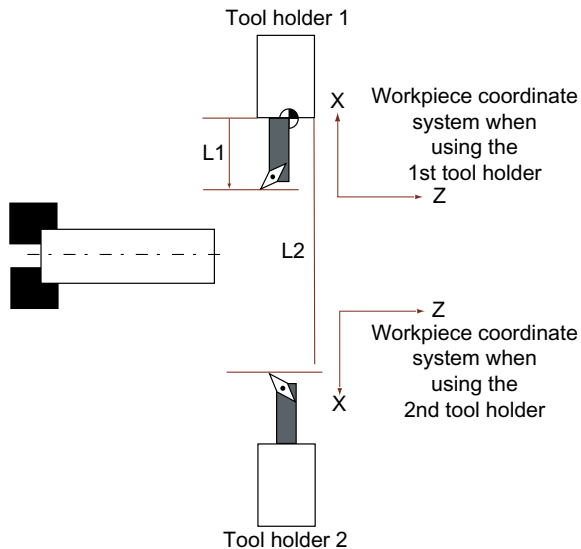

In the simulation, the tool is always displayed on the correct side, just the same as it is used at the machine.

The programmed C offset around 180° only affects C axes, not spindles.

It is not possible to machine a thread with tools that are distributed between both tool holders.

G code programming

The following points must be taken into account for G code programming:

- After a tool change, tool mirroring on the second tool holder is automatically activated.
- When a TRANSMIT command is programmed, tool mirroring on the second tool holder is automatically activated.

18.2 Measure tool

Selection options "Toolholder 1" and "Toolholder 2" are available for scratching when measuring a tool. This is how you set the tool holder in which the tool to be measured is located.

The screenshot shows the Siemens CNC control interface during a tool measurement process. The top status bar includes the 'M' icon, 'JOG' mode, and 'SIEMENS' branding. Below this, the control area is divided into several sections:

- Machine Position [mm]:** Shows coordinates for XM1, YM1, and ZM1, all set to 0.000. Below these are BM1 (0.000°) and ZM3 (0.000).
- T,F,S Data:** Displays tool information including T 400_SL3, S2, and F 0.000 mm/rev. The S2 field is highlighted, showing '0' and 'Master 0'.
- Measure: length manually:** This section features a 3D model of a tool and its holder. The tool is labeled '400_SL3' and 'D 1'. The tool holder is labeled 'Tool holder 1' and has a value of '0.000' in the 'X0' field. The 'Tool data' table shows X: 100.000, Z: -100.000, and R: 30.000.
- Right-hand Panel:** Contains several buttons: 'Select tool', 'Save position', 'X', 'Z', 'Set length', and 'Back'.
- Bottom Bar:** Includes icons for 'T,S,M', 'Set W0', 'Meas. workp.', 'Meas. tool', 'Position', and 'Stock rem.'.

Teaching in a program

19.1 Overview

The "Teach in" function can be used to edit programs in the "AUTO" and "MDA" modes. You can create and modify simple traversing blocks.

You traverse the axes manually to specific positions in order to implement simple machining sequences and make them reproducible. The positions you approach are applied.

In the "AUTO" teach-in mode, the selected program is "taught".

In the "MDA" teach-in mode, you teach to the MDA buffer.

External programs, which may have been generated offline, can therefore be adapted and modified according to your specific requirements.

Note**Not possible to teach-in program**

When an EES program has been selected, it is not possible to teach-in programs.

19.2 General sequence

General sequence

Select the desired program block, press the relevant softkey "Teach position", "Rap. tra. G01", "Straight line G1" or "Circ. interm. pos. CIP", and "Circ. end pos. CIP" and traverse the axes to change the program block.

You can only overwrite a block with a block of the same type.

- OR -

Position the cursor at the desired point in the program, press the relevant softkey "Teach position", "Rap. tra. G01", "Straight line G1" or "Circ. interm. pos. CIP", and "Circ. end pos. CIP" and traverse the axes to insert a new program block.

In order for the block to be inserted, the cursor must be positioned in an empty line using the cursor key and input key.

Press the "Accept" softkey to teach-in the modified or new program block.

Note

All defined axes are "taught in" in the first teach-in block. In all additional teach-in blocks, only axes modified by axis traversing or manual input are "taught in".

If you exit teach-in mode, this sequence begins again.

Operating mode or operating area switchover

If you switch to another operating mode or operating area in teach-in mode, the position changes will be canceled and teach-in mode will be cleared.

19.3 Inserting a block

You have the option of traversing the axes and writing the current actual values directly to a new position block.

Requirement

"AUTO" mode: The program to be edited is selected.

Proceed as follows



1. Select the "Machine" operating area.



2. Press the <AUTO> or <MDA> key.



3. Press the <TEACH IN> key.



4. Press the "Teach prog." softkey.

5. Traverse the axes to the relevant position.



6. Press the "Teach position" softkey.

A new program block with the current actual position values will be created.

19.3.1 Input parameters for teach-in blocks

Parameters for teach-in of position and teach-in of G0, G1, and circle end position CIP

Parameter	Description
X	Approach position in X direction
Y	Approach position in Y direction
Z	Approach position in Z direction
F	Feedrate (mm/r; mm/min) - only for teach-in of G1 and circle end position CIP
	

Parameters for teach-in of circle intermediate position CIP

Parameter	Description
I	Coordinate of the circle center point in the X direction
J	Coordinate of the circle center point in the Y direction
K	Coordinate of the circle center point in the Z direction

Transition types for teach-in of position and teach-in of G0 and G1, and ASPLINE

The following parameters are offered for the transition:

Parameter	Description
G60	Exact stop
G64	Corner rounding
G641	Programmable corner rounding
G642	Axis-specific corner rounding
G643	Block-internal corner rounding
G644	Axis dynamics corner rounding

Motion types for teach-in of position and teach-in of G0 and G1

The following motion parameters are offered:

Parameter	Description
CP	Path-synchronous
PTP	Point-to-point
PTPG0	Only G0 point-to-point

Transition behavior at the beginning and end of the spline curve

The following motion parameters are offered:

Parameter	Description
Start	
BAUTO	Automatic calculation
BNAT	Curvature is zero or natural
BTAN	Tangential
End	
EAUTO	Automatic calculation
ENAT	Curvature is zero or natural
ETAN	Tangential

19.4 Teach-in via Windows

19.4.1 General

The cursor must be positioned on an empty line.

The windows for pasting program blocks contain input and output fields for the actual values in the WCS. Depending on the default setting, selection fields with parameters for motion behavior and motion transition are available.

When first selected, the input fields are empty unless axes were already traversed before the window was selected.

All data from the input/output fields are transferred to the program via the "Accept" softkey.

Precondition

"AUTO" mode: The program to be edited is selected.

Procedure



1. Select the "Machine" operating area.



2. Press the <AUTO> or <MDA> key.



3. Press the <TEACH IN> key.

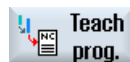

4. Press the "Teach prog." softkey.

5. Use the cursor and input keys to position the cursor at the desired point in the program.

If an empty row is not available, insert one.



6. Press the softkeys "Rap. tra. G0", "Straight line G1", or Circ. intern. pos. CIP" and "Circ. end pos. CIP".

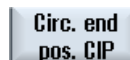

The relevant windows with the input fields are displayed.

7. Traverse the axes to the relevant position.



8. Press the "Accept" softkey.

A new program block will be inserted at the cursor position.



- OR -

Press the "Cancel" softkey to cancel your input.

19.4.2 Teach in rapid traverse G0

You traverse the axes and teach-in a rapid traverse block with the approached positions.

Note

Selection of axes and parameters for teach-in

You can select the axes to be included in the teach-in block in the "Settings" window.

You also specify here whether motion and transition parameters are offered for teach-in.

19.4.3 Teach in straight G1

You traverse the axes and teach-in a machining block (G1) with the approached positions.

Note

Selection of axes and parameters for teach-in

You can select the axes to be included in the teach-in block in the "Settings" window.

You also specify here whether motion and transition parameters are offered for teach-in.

19.4.4 Teaching in circle intermediate and circle end point CIP

Enter the intermediate and end positions for the circle interpolation CIP. You teach-in each of these separately in a separate block. The order in which you program these two points is not specified.

Note

Make sure that the cursor position does not change during teach-in of the two positions.

You teach-in the intermediate position in the "Circle intermediate position CIP" window.

You teach-in the end position in the "Circle end position CIP" window.

The intermediate or interpolation point is only taught-in with geometry axes. For this reason, at least 2 geometry axes must be set up for the transfer.

Note

Selection of axes for teach in

You can select the axes to be included in the teach-in block in the "Settings" window.

19.4.5 Teach-in A spline

For Akima-spline interpolation, you enter interpolation points that are connected by a smooth curve.

Enter a starting point and specify a transition at the beginning and end.

You teach-in each interpolation point via "Teach in of position".



Software option

You require the "Spline-Interpolation" option for A Spline interpolation.

Note

The relevant option bit must be set to enable you to program a spline interpolation.



Machine manufacturer

Please refer to the machine manufacturer's specifications.

Procedure



1. Select the "Machine" operating area.



2. Press the <AUTO> or <MDA> key.



3. Press the <TEACH IN> key.



4. Press the "Teach prog." softkey.



5. Press the ">>" and "ASPLINE" softkeys.
The "Akima-spline" window opens with the input fields.



6. Traverse the axes to the required position and if necessary, set the transition type for the starting point and end point.



7. Press the "Accept" softkey.
A new program block will be inserted at the cursor position.
- OR -



- Press the "Cancel" softkey to cancel your input.
-

Note

Selection of axes and parameters for teach-in

You can select the axes to be included in the teach-in block in the "Settings" window.

You also specify here whether motion and transition parameters are offered for teach-in.

19.5 Editing a block

You can only overwrite a program block with a teach-in block of the same type.

The axis values displayed in the relevant window are actual values, not the values to be overwritten in the block.

Note

If you wish to change any variable in a block in the program block window other than the position and its parameters, then we recommend alphanumerical input.

Requirement

The program to be processed is selected.

Procedure



1. Select the "Machine" operating area.



2. Press the <AUTO> or <MDA> key.



3. Press the <TEACH IN> key.



4. Press the "Teach prog." softkey.



5. Click the program block to be edited.

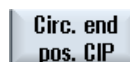

6. Press the relevant softkey "Teach position", "Rap. tra. G0", "Straight line G1", or "Circ. interm. pos. CIP", and "Circ. end pos. CIP".

The relevant windows with the input fields are displayed.



7. Traverse the axes to the desired position and press the "Accept" softkey.

The program block is taught with the modified values.

- OR -



Press the "Cancel" softkey to cancel the changes.

19.6 Selecting a block

You have the option of setting the interrupt pointer to the current cursor position. The next time the program is started, processing will resume from this point.

With teach-in, you can also change program areas that have already been executed. This automatically disables program processing.

You must press reset or select a block to resume the program.

Requirement

The program to be processed is selected.

Proceed as follows



1. Select the "Machine" operating area.



2. Press the <AUTO> key.



3. Press the <TEACH IN> key.



4. Press the "Teach prog." softkey.



5. Place the cursor on the desired program block.
6. Press the "Block selection" softkey.

19.7 Deleting a block

You have the option of deleting a program block entirely.

Requirement

"AUTO" mode: The program to be processed is selected.

Procedure



1. Select the "Machine" operating area.



2. Press the <AUTO> or <MDA> key.



3. Press the <TEACH IN> key.



4. Press the "Teach prog." softkey.



5. Click the program block to be deleted.



6. Press the ">>" and "Delete block" softkeys.

The program block on which the cursor is positioned is deleted.

19.8 Settings for teach-in

In the "Settings" window, you define which axes are to be included in the teach-in block and whether motion-type and continuous-path mode parameters are to be provided.

Proceed as follows



1. Select the "Machine" operating area.



2. Press the <AUTO> or <MDA> key.



3. Press the <TEACH IN> key.



4. Press the "Teach prog." softkey.



5. Press the ">>" and "Settings" softkeys.
The "Settings" window appears.



6. Under "Axes to be taught" and "Parameters to be taught", select the check boxes for the relevant settings and press the "Accept" softkey to confirm the settings.

HT 8 (840D sl only)

20.1 HT 8 overview

The mobile SINUMERIK HT 8 handheld terminal combines the functions of an operator panel and a machine control panel. You are thus provided the possibility of monitoring, operating, teaching and programming in immediate proximity to the machine.

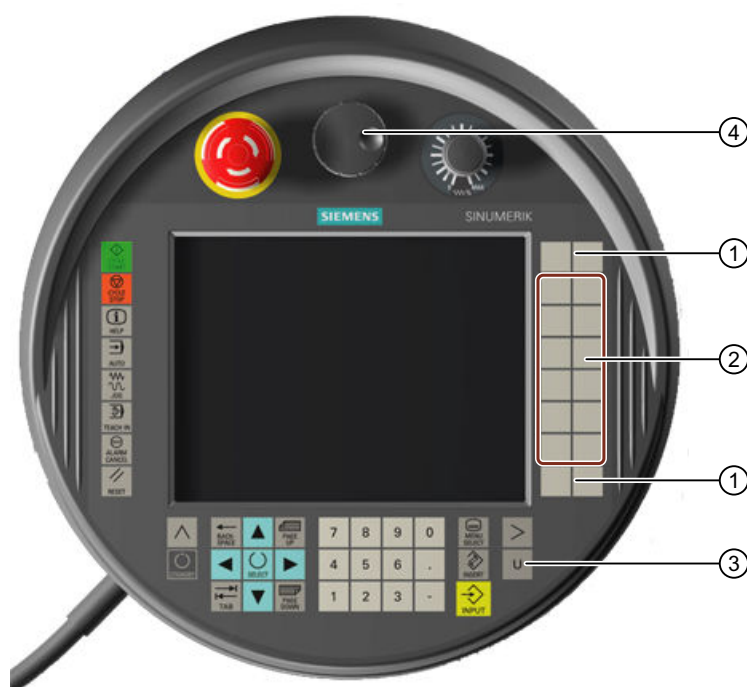

- ① Customer keys (user-defined)
- ② Traversing keys
- ③ User menu key
- ④ Handwheel (optional)

Operation

The 7.5" TFT color display provides touch operation.

Membrane keys are featured for traversing the axes, numeric input, control of the cursor, and for machine control panel functions (e.g. start and stop).

The HT 8 is equipped with an emergency stop button and two 3-stage enabling buttons. You can also connect an external keyboard.

References

For more information about connection and startup of the HT 8, see the following references:

Commissioning Manual SINUMERIK Operate (IM9) / SINUMERIK 840D sl

Customer keys

The four customer keys can be assigned arbitrarily and can be configured customer-specifically.



Machine manufacturer

Please observe the information provided by the machine manufacturer.

Integrated machine control panel

An MCP is integrated in the HT 8. It is comprised of keys (e.g. start and stop) as well as softkeys emulating keys.

A description of individual keys can be obtained in the chapter "Controls on the machine control panel".

Note

PLC interface signals that are triggered via the softkeys of the machine control panel menus are edge triggered.

Enabling button

The HT 8 has two enabling buttons. You are therefore provided the opportunity of activating the acknowledgement function for operator actions which require approval (e.g. showing the traversing keys) with either hand.

Enabling buttons are available for the following key positions:

- Released (no activation)
- Enabling (center position) - enabling for channel 1 and 2 is on the same switch
- Panic (completely pushed through)

Traversing keys

To traverse the axes of your machine using the traversing keys of the HT 8, you must select "JOG" mode or either the "Teach In" or "Ref.Point" submode. You have to press the enabling button depending on the setting.



Machine manufacturer

Please observe the information provided by the machine manufacturer.

Virtual keyboard

A virtual keyboard is available for the easy entry of values.

Changing the channel

- You are able to switch the channel by touch in the status display:
 - In the Machine operating area (large status display), by touch operation of the channel display in the status display.
 - In the other operating areas (no status display), by touch operation of the channel display in the screen headers (yellow field).
- The "1... n CHANNEL" softkey is available in the machine control panel menu that can be reached via the user menu key "U".

Operating area switchover

You display the operating area menu by touching the display symbol for the active operating area in the status display.

Handwheel

The HT 8 is available with a hand wheel.

References

Information regarding connection can be obtained from the following references:
Operator Components and Networking Manual; SINUMERIK 840D sl/840Di sl

20.2 Traversing keys

The traversing keys are not labeled. However, you can display a label for the keys in place of the vertical softkey bar.

Labeling of the traversing keys is displayed for up to six axes on the touch panel by default.



Machine manufacturer

Please refer to the machine manufacturer's specifications.

Showing and hiding

You can link the showing and hiding of the label to activation of the enabling button, for example. In this case, the traversing keys are displayed when you press the enabling button.

If you release the enabling button, the traversing keys are hidden again.



Machine manufacturer

Please refer to the machine manufacturer's specifications.



All existing vertical and horizontal softkeys are covered or hidden, i.e. other softkeys cannot be used.

20.3 Machine control panel menu

You select keys from the machine control panel which are reproduced by the software by touch operation of the relevant softkeys.

See Section "Controls on the machine control panel" for a description of the individual keys.

Note

PLC interface signals that are triggered via the softkeys of the machine control panel menus are edge triggered.

Showing and hiding

The user menu key "U" displays the CPF softkey bar (vertical softkey bar) and the user softkey bar (horizontal softkey bar).

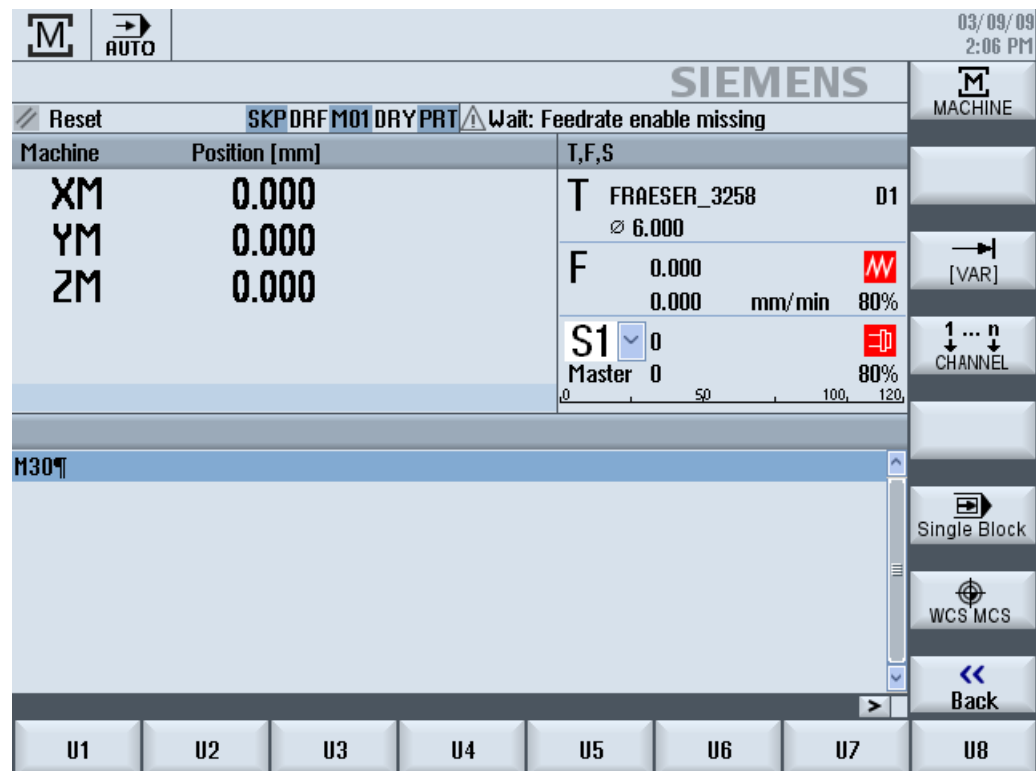

Press the menu forward key to extend the horizontal user softkey bar. There are 8 additional softkeys available.



You use the "Back" softkey to hide the menu bar again

Softkeys on the machine control panel menu

Available softkeys:

- "Machine" softkey Select the "Machine" operating area
- "[VAR]" softkey Select the axis feedrate in the variable increment
- "1... n CHANNEL" softkey Changing the channel
- "Single Block" softkey Switch single block execution on/off
- "WCS MCS" softkey Switch between WCS and MCS
- "Back" softkey Close window

Note

The window will automatically disappear when changing regions areas with the <MENU SELECT> key.

20.4 Virtual keyboard

The virtual keyboard is used as the input device for touch operator panels.

Open the virtual keyboard by double-clicking on an input-enabled operator control (program editor, editing fields). It is possible to position the virtual keyboard anywhere within the user interface.

You can choose between a full keyboard and a downsized keyboard featuring the numeric keypad only. With the full keyboard, it is possible to switch between English keyboard layout and the keyboard layout which corresponds with the actual language set for the respective country.

Procedure

1. Position the cursor on the desired entry field.
2. Click the input field.
The virtual keyboard is displayed.
3. Enter your values via the virtual keyboard.
4. Press the <INPUT> key.



- OR -

Position the cursor on an another operator element.

The value is accepted and the virtual keyboard is closed.

Positioning of the virtual keyboard

Press and hold the open area to the left of the icon for "Close window" with the stylus or a finger. Move the keyboard to the desired position.

Special keys on the virtual keyboard

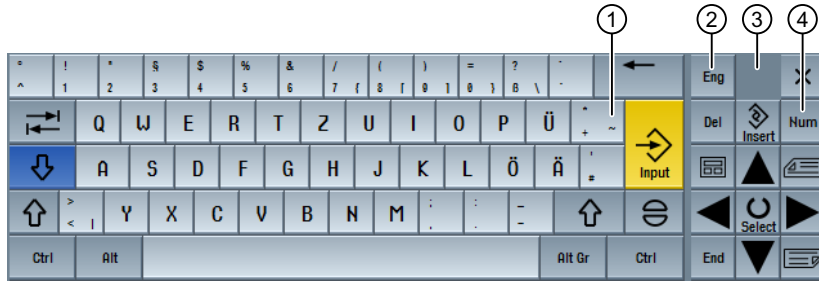

- ① "Tilde" key
 - Changes the sign in a numerical entry field.
 - A tilde character is inserted in a text box (e.g. program editor).
- ② "Eng" key
Toggles the keyboard assignment between the English keyboard assignment and the keyboard assignment for the current language setting.
- ③ Area for positioning the virtual keyboard.
- ④ "Num" key
Reduces the virtual keyboard to the number block.

Number block of the virtual keyboard



Press the "ABC" key to return to the full keyboard.

20.5 Calibrating the touch panel

It is necessary to calibrate the touch panel upon first connection to the controller.

Note

Recalibration

If the operation is not exact, then redo the calibration.

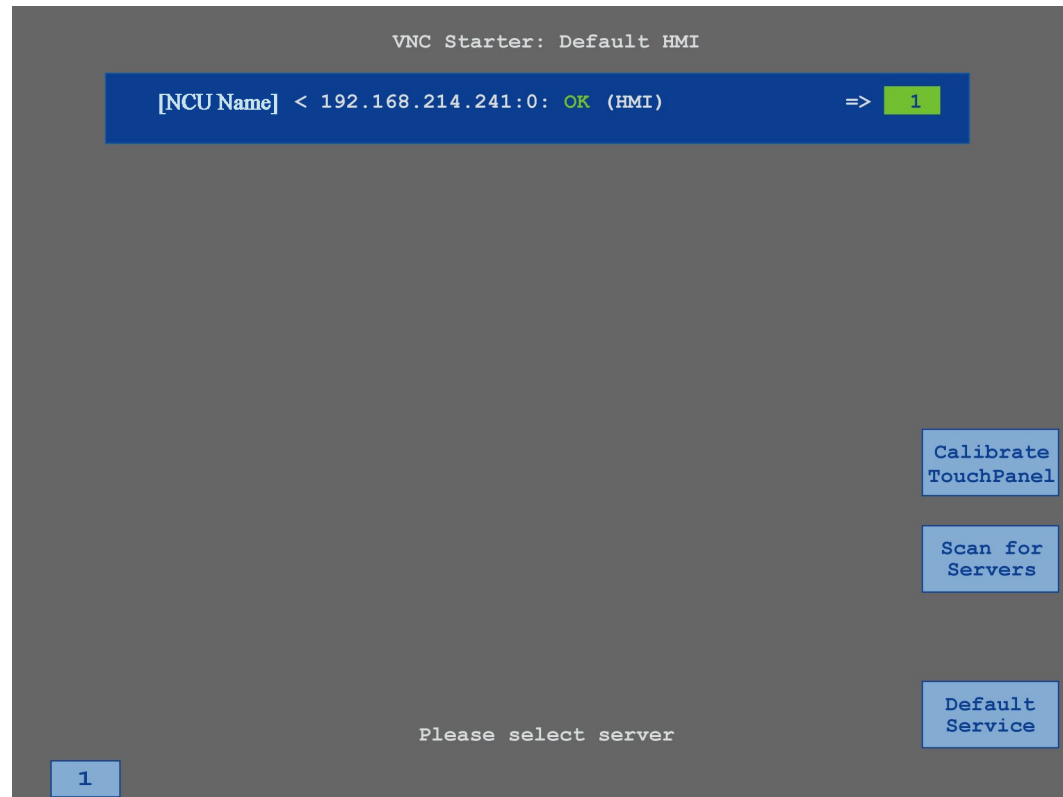

Procedure



1. Press the menu back key and the <MENU SELECT> key at the same time to start the TCU service screen.



2. Touch the "Calibrate TouchPanel" button.
The calibration process will be started.
3. Follow the instructions on the screen and touch the three calibration points one after the other.
The calibration process has terminated.
4. Touch the horizontal softkey "1" or the key with the number "1" to close the TCU service screen.

Ctrl-Energy

21.1 Functions

The "Ctrl-Energy" function provides you with the following options to improve the energy utilization of your machine.

Ctrl-E Analysis: Measuring and evaluating the energy consumption

Acquiring the actual energy consumption is the first step to achieving better energy efficiency. The energy consumption is measured and displayed at the control using the SENTRON PAC multi-function device.

Depending on the configuration and connection of the SENTRON PAC, you have the possibility of either measuring the power of the whole machine or only a specific load.

Independent of this, the power is determined directly from the drives and displayed.

Ctrl-E Profiles: Control of energy saving states of the machine

To optimize the energy consumption, you have the option of defining energy saving profiles and saving them. For instance, your machine has a basic and a more sophisticated energy-saving mode – or under certain conditions, automatically switches itself off.

These defined energy states are saved as profiles. At the user interface, you have the possibility of activating these energy-saving profiles (e.g. the so-called tea break key).

Note

Ctrl-E Deactivating profiles

Disable Ctrl-E profiles before a series commissioning in order to prevent the NCU unintentionally shutting down.



Machine manufacturer

Please observe the information provided by the machine manufacturer.

Note

Calling of the function via shortcut key

Press keys <CTRL> + <E> to call the "Ctrl Energy" function.

21.2 Ctrl-E analysis

21.2.1 Displaying energy consumption

The SINUMERIK Ctrl-Energy entry screen provides an easy-to-interpret overview of the energy consumption of the machine. To display the values and the graphical representation, a Sentron PAC must be connected and a long-term measurement configured.

This shows a consumption display with the following bar chart:

- Current power display
- Measurement of the current energy consumption
- Comparison measurement for the energy consumption

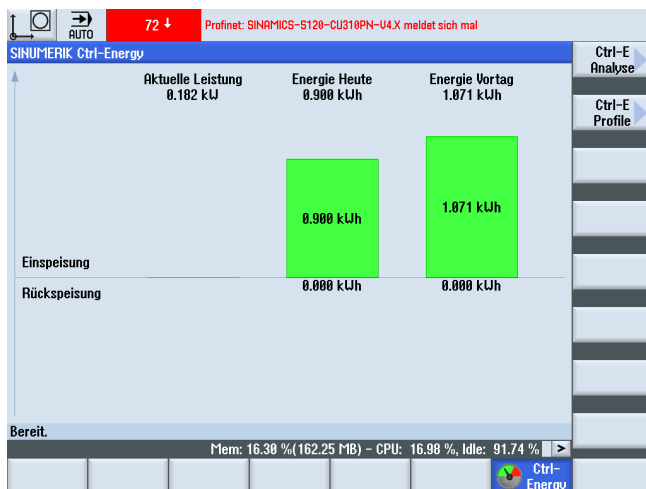

Figure 21-1 Ctrl-Energy entry screen with display of the current energy consumption

Display in the "Machine" operating area

The first row of the status display shows the current power status of the machine.

Display	Meaning
	A red bar indicates that the machine is not operating productively.
	A dark-green bar in the positive direction indicates that the machine is operating productively and consuming energy.
	A light-green bar in the negative direction indicates that the machine is feeding energy back into the power supply system.

References

Information on the configuration is provided in the following reference:

System Manual "Ctrl-Energy", SINUMERIK 840D sl / 828D

Procedure

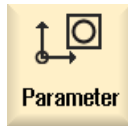

1. Select the "Parameter" operating area.



2. Press the menu forward key and then the "Ctrl-Energy" softkey.



- OR -



+

Press the <Ctrl> + <E> keys.



The "SINUMERIK Ctrl-Energy" window opens.

21.2.2 Displaying the energy analyses

You can obtain a detailed overview of the energy usage in the "Ctrl-E analyse" window.

You obtain the usage display for the following components:

- Sum of the axes
- Sum of the units, if auxiliary units are configured in the PLC
- Sentron PAC
- Sum of the machine

Detailed display of the energy usage

Further, you also have the option of listing the usage values for all drives and where relevant, all auxiliary units.

References

Information on the configuration is provided in the following reference:

System Manual "Ctrl-Energy", SINUMERIK 840D sl / 828D

Procedure



1. You are in the "SINUMERIK Ctrl-Energy" entry window.



2. Press the "Ctrl-E analysis" softkey.
The "Ctrl-E Analysis" window opens. You obtain the summed usage values for all of the components.



3. Press the "Details", softkey to display the energy usage of individual drives and auxiliary units.

21.2.3 Measuring and saving the energy consumption

For the currently selected axes, auxiliary units, SentronPAC or the complete machine you have the option of measuring and recording the energy consumption.

Measurement of the energy consumption by part programs

The energy consumption of part programs can be measured. Single drives are taken into account for the measurement.

You specify in which channel the start and stop of the part program should be initiated and how many repetitions you want to measure.

Save measurements

Save the measured consumption values so that you can subsequently compare the data.

Note

Up to 3 data sets are saved. The oldest data set is automatically overwritten if there are more than three measurements.

Measurement duration

The measurement duration is limited. The measurement is terminated if the maximum measurement time has been reached. The corresponding message is output in the dialog line.



Machine manufacturer



Please observe the information provided by the machine manufacturer.

Precondition

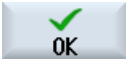

You have pressed the "Ctrl-E analyse" softkey and the "Ctrl-E analyse" window has been opened.

Procedure

- | | |
|---|---|
|  | 1. Press the "Start measurement" softkey.
The "Setting Measurement: Select Device" window opens. |
|  | 2. Select the desired device in the list, possibly activate the "Measure part program" checkbox, enter the number of repetitions, select the required channel, and press the "OK" softkey.
The trace is started. |
|  | 3. Press the "Stop measurement" softkey.
The measurement is terminated. |
|  | 4. Press the "Save measurement" softkey to save the consumption values of the actual measurement. |

The selection of the axis to be measured depends on the configuration.

References

Information on the configuration is provided in the following reference:

System Manual "Ctrl-Energy", SINUMERIK 840D sl / 828D

21.2.4 Tracking measurements



You have the option of graphically displaying the actual and saved measurement curves.

Precondition



You have pressed the "Ctrl-E analyse" softkey and the "Ctrl-E analyse" window has been opened.

Procedure

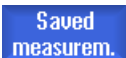
- | | |
|---|--|
|  | 1. Press the "Graphic" softkey.
The actual measurement is displayed as a blue measurement curve in the "Ctrl-E analyse" window. |
|  | 2. Press the "Saved measurements" softkey to display the measurements last saved.
In addition, measurement curves with 3 different colors paths are displayed together with the measurement time. |
|  | 3. Press the "Saved measurements" softkey again if you only want to see the actual measurement. |

21.2.5 Tracking usage values

You have the option of displaying the actual and saved usage values in a detailed table.

Display	Meaning
Start of the measurement	Shows the time at which the measurement was started by pressing the "Start measurement" softkey.
Duration of the measurement [s]	Shows the measurement duration in seconds until the "Stop measurement" softkey is pressed.
Device	Displays the selected measured component. <ul style="list-style-type: none"> • Manual (fixed value, z.B. base load, defined in the PLC) • Sentron PAC • Sum of the units (if defined in the PLC) • Sum of the axes • Total, machine
Supplied energy [kWh]	Displays the energy drawn by the selected measured component in kilowatts per hour.
Regenerated energy [kWh]	Shows the regenerated energy of the selected measured component in kilowatts per hour.
Energy totals [kWh]	Shows the total of all measured drive values or the total of all axes as well as fixed value and Sentron PAC.

Display in the "Ctrl-E analysis" window: Table"

Precondition



1. You have pressed the "Ctrl-E analyse" softkey and the "Ctrl-E analyse" window has been opened.
2. You have already saved measurements.

Procedure



Press the "Graphic" and "details" softkeys.

In the "Ctrl-E analysis" window: Details", measurement data and usage values of the last three saved measurements – and possibly an actual measurement – are displayed in a table.

21.2.6 Comparing usage values

You have the option of comparing usage values (power drawn and power fed back) of actual and saved measurements.

Precondition



1. You have pressed the "Ctrl-E analyse" softkey and the "Ctrl-E analyse" window has been opened.
2. You have already saved measurements.

Procedure



1. Press the "Graphic" softkey.



2. Press the "Compare measurements" softkey.
Window "Ctrl-E Analysis": Compare" opens.
The power drawn and the recovered power of the actual measurement are displayed in a bar diagram.



3. Press the "Saved measurements" softkey to compare the last 3 measurements that were saved.



4. Press the "Saved measurements" softkey again if you only want to see the actual comparison.

21.2.7 Long-term measurement of the energy consumption

The long-term measurement of energy consumption is performed in the PLC and saved. The values from times in which the HMI is not active are also recorded.

Measured values

The infeed and regenerative power values as well as the sum of the power are displayed for the following periods:

- Current and previous day
- Current and previous month
- Current and previous year

Precondition

SENTRON PAC is connected.

Procedure



1. The "Ctrl-E Analysis" window is open.
2. Press the "Long time measurement" softkey.
The "SINUMERIK Ctrl-Energy Analysis Long-term Measurement" window opens.
The results of the long-term measurement are displayed.
3. Press the "Back" softkey to terminate the long-term measurement.

21.3 Ctrl-E profiles

21.3.1 Using the energy-saving profile

In the "Ctrl-E profiles" window, you can display all of the defined energy-saving profiles. Here, you have the option of directly activating or inhibiting a required energy-saving profile, or re-enabling profiles.

SINUMERIK Ctrl-Energy energy-saving profiles

Display	Meaning
Energy-saving profile	All energy-saving profiles are listed.
active in [min]	The remaining time until the defined profile is reached is displayed.

Note

Disable all energy-saving profiles

For example, in order not to disturb the machine while measurements are being made, select "Disable all".

Once the pre-warning time of a profile has been reached, an alarm window that shows the remaining time is displayed. Once the energy-saving mode has been reached, then an appropriate message is displayed in the alarm line.

Predefined energy-saving profiles

Energy-saving profile	Meaning
Simple energy-saving mode (machine standby)	Machine units that are not required are either throttled or shut down. When required, the machine is immediately ready to operate again.
Full energy-saving mode (NC standby)	Machine units that are not required are either throttled or shut down. Wait times are incurred at the transition into the ready to operate state.
Maximum energy-saving mode (auto shut-off)	The machine is completely switched-off. Longer wait times are incurred at the transition into the ready to operate state.



Machine manufacturer

The selection and function of the displayed energy-saving profiles can differ. Please observe the information provided by the machine manufacturer.

References

Information on the configuration of the energy-saving profiles is provided in the following reference:

System Manual "Ctrl-Energy", SINUMERIK 840D sl / 828D

Procedure

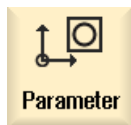

1. Select the "Parameter" operating area.



2. Press the menu forward key and then the "Ctrl-Energy" softkey.



- OR -

Press the <CTRL> + <E> keys.



+



3. Press the "Ctrl-E profile" softkey.

The "Ctrl-E Profile" window opens.



4. Position the cursor on the required energy-saving profile and press the "Activate immediately" softkey if you wish to directly activate this state.



5. Position the cursor on the required energy-saving profile and press the "Disable profile" softkey if you wish to disable this state.

The profile is inhibited and does not become active. The energy-saving profile is grayed-out and displayed without any time information.

The labeling of the "Disable profile" softkey changes to "Enable profile".



Press the "Enable profile" softkey in order to withdraw the energy-saving profile disable.



5. Press the "Disable all" softkey in order to disable all states.

All the profiles are disabled and cannot become active.

The labeling of the "Disable all" softkey changes to "Enable all".



6. Press the "Enable all" softkey to withdraw the disable for all profiles.

Easy Message (828D only)

22.1 Overview

Easy Message enables you to be informed about certain machine states by means of SMS messages via a connected modem:

- For example, you wish to be informed about EMERGENCY STOP states.
- You would like to know when a batch has been completed.

Control commands

You activate or deactivate a user using HMI commands.

Syntax: [User ID] deactivate, [User ID] activate

Active users

In order to receive an SMS message for certain events, you must be activated as user.

User logon

As registered user, you can log on via SMS to inquire about messages.

Action log

You can obtain precise information about incoming and outgoing messages via SMS logs.

References

Information about the GSM modem can be found in the reference:

- PPU SINUMERIK 828D Manual

You can find further information on the MODEM MD720 on the Internet at:

- MODEM MD720 (<https://support.industry.siemens.com/cs/mdm/102401328?c=70936043019&pnid=15923&lc=en-WW>)

Calling the SMS Messenger



1. Select the "Diagnostics" operating area.

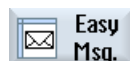

2. Press the "Easy Msg." softkey.

22.2 Activating Easy Message

To commission the connection to the modem for the SMS Messenger, activate the SIM card at the initial start-up.

Requirement

The modem is connected and the interfaces are activated.



Machine manufacturer

The modem is activated via the machine data 51233 \$MSN_ENABLE_GSM_MODEM. Please refer to the machine manufacturer's specifications.

Procedure

Activating the SIM card



1. Press the "Easy Msg." softkey.

The "SMS Messenger" window appears.

"Status" shows that the SIM card has not been activated with a PIN.



2. Enter the PIN, repeat the PIN and press the "OK" softkey.



3. If you made an incorrect entry several times, enter the PUK code in the "PUK Input" window and press the "OK" softkey to activate the PUK code. The "PIN input" window is opened and you can enter the PIN number as usual.

Activating a new SIM card

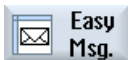

1. Press the "Easy Msg." softkey.

The "SMS Messenger" window appears.

"Status" shows that the connection to the modem has been activated.



2. Press the "Settings" softkey.



3. Press the "Delete PIN" softkey to delete the stored PIN.

Enter the new PIN in the "PIN Input" window at the next power up.

22.3 Creating/editing a user profile

User identification

Display	Meaning
User name	Name of the user to be created or logged on.
Telephone number	Telephone number of the user to which the messages are to be sent. The telephone number must include the country code in order that control commands can identify the sender (e.g. +491729999999)
User ID	The user ID has 5 digits (e.g. 12345) <ul style="list-style-type: none"> • The ID is used to activate and deactivate the user via SMS (e.g. "12345 activate") • The ID is used to additionally verify the incoming and outgoing messages and to activate the control commands.

Events that can be selected

You must set-up the events for which you receive notification.

Note

Selecting alarms

You have the option of selecting tool management type or measuring cycles alarms. This means that you obtain notification by SMS as soon as alarms are output, without having to know the number ranges.

Requirement

The modem is connected.

Procedure

Creating a new user



1. Press the "User profiles" softkey.
The "User Profiles" window appears.



2. Press the "New" softkey.
3. Enter the name and telephone number of the user.
4. If required, enter the ID number of the user.
5. In the area "send SMS for the following events" area, activate the appropriate checkbox and when required, enter the desired value (e.g. the unit quantity, which when it is reached, a notification is sent).

- OR -



Press the "Default" softkey.

The appropriate window is opened and displays the default values.



6. Press the "Send test message" softkey.

An SMS message with predefined text is sent to the specified telephone number.

Editing user data and events



1. Select the user whose data you want to edit and press the "Edit" softkey. The input fields can be edited.
2. Enter new data and activate the desired settings.

- OR -



Press the "Default" softkey to accept the default values.

22.4 Setting-up events

In the "Send SMS for the following events" area, select the events using the check box, which when they occur, an SMS is sent to the user.

- Programmed messages from the part program (MSG)
In the part program, program an MSG command via which you receive an SMS.
Example: MSG ("SMS: An SMS from a part program")
- Select the following events using the <SELECT> key
 - The workpiece counter reaches the following value
An SMS is sent if the workpiece counter reaches the set value.
 - The following program progress is reached (percent)
An SMS is sent if, when executing a part program, the set progress is reached.
 - Actual NC program reaches runtime (minutes)
An SMS is sent after the set runtime has been reached when executing an NC program.
 - Tool usage time reaches the following value (minutes)
An SMS is sent if the usage time of the tool reaches the set time when executing a part program (derived from \$AC_CUTTING_TIME).
- Messages/alarms from the Tool Manager
An SMS is sent if messages or alarms are output to the Tool Manager.
- Measuring cycle messages for tools
An SMS is sent if measuring cycle messages are output that involve tools.
- Measuring cycle messages for workpieces
An SMS is sent if measuring cycle messages are output that involve workpieces.
- Sinumerik messages/alarms (error when executing)
An SMS is sent if NCK alarms or messages are output that cause the machine to come to a standstill.
- Machine faults
An SMS is sent if PLC alarms or messages are output that cause the machine to come to a standstill (i.e. PLC alarms with an Emergency Stop response).
- Maintenance intervals
An SMS is sent if the service planner registers pending maintenance work.
- Additional alarm numbers:
Here, specify additional alarms where you should be notified if they occur.
You can enter individual alarms, several alarms or alarm number ranges.
Examples:
1234,400
1000-2000
100,200-300

Requirement

- The "User profiles" window is opened.
- You selected the event "Measuring cycle messages for tools", "Measuring cycle messages for workpieces", "Sinumerik messages/alarms (errors when executing)", "Machine faults" or "Maintenance intervals".

Editing events



1. Activate the required check box and press the "Details" softkey. The appropriate window opens (e.g. "Measuring cycle messages for workpieces") and shows a list of the defined alarm numbers.



2. Select the corresponding entry and press the "Delete" softkey to remove the alarm number from the list.

- OR -



Then press the "New" softkey if you wish to create a new entry. The "Create new entry" window opens.



Enter the data and press the "OK" softkey to add the entry to the list.



Press the "Save" softkey to save the settings for the result.



3. Press the "Standard" softkey to return to the standard settings for the events.

22.5 Logging an active user on and off

Only active users receive an SMS message for the specified events.

You can activate users, already created for Easy Message, with certain control commands via the user interface or via SMS.

Requirement



The connection has been established to the modem.

Procedure



1. Press the "User profiles" softkey.



2. Select the desired user in the User name field and press the "User active" softkey.



Note

Repeat step 2 to activate further users.

- OR -

Send an SMS with the User ID and the "activate" text to the control (e.g. "12345 activate")



If the telephone number and the user ID match the stored data, the user profile is activated.

You receive a message of success or failure per SMS.



3. Press the "User active" softkey to log off an activated user.





- OR -

Send an SMS with the "deactivate" text (e.g. "12345 deactivate") to log off from the Messenger.

An SMS message is not sent to the deactivated user for the events specified in the user profile.

22.6 Displaying SMS logs

The SMS data traffic is recorded in the "SMS Log" window. This means that you have the possibility of assigning activities (from a time perspective) to a particular fault situation.

Symbols	Description
	Incoming SMS message for the Messenger.
	Message that has reached the Messenger, but which has not been processed (e.g. incorrect user ID or unknown account).
	SMS message sent to a user.
	Message that has not reached the user because of an error.

Requirement



The connection has been established to the modem.

Procedure



1. Press the "SMS log" softkey.



The "SMS Log" window appears.

All the messages that have been sent or received by the Messenger are listed.



2. Press the "Incoming" or "Outgoing" softkey to restrict the list.

22.7 Making settings for Easy Message

You can change the following Messenger configuration in the "Settings" window:

- Name of the controller that is part of an SMS message
- Number of sent messages
 - The SMS counter provides information on all sent messages.
 - Limit the number of sent messages in order to receive an overview of the costs through SMS messages, for example.

Setting the SMS counter to zero



When a set limit is reached, no further SMS messages are sent.
Press the "Reset SMS counter" softkey to reset the counter to zero.

Requirement



The connection has been established to the modem.

Procedure



1. Press the "Settings" softkey.
2. Enter an arbitrary name for the controller in the "Machine name" field.
3. If you want to limit the number of sent SMS messages then select the "Specify limit for SMS counter" entry and enter the desired number.



When the maximum number of messages is reached, you obtain a corresponding error message.

Note

Check the SMS log to see the exact time when the limit was reached.



4. Press the "Standard" softkey.
If you have freely selected a machine name, this is replaced by a default name (e.g. 828D).

Easy Extend

23.1 Overview

Easy Extend enables machines to be retrofitted with additional devices, which are controlled by the PLC or that require additional NC axes (such as bar loaders, swiveling tables or milling heads), at a later point in time. These additional devices are easily commissioned, activated, deactivated or tested with Easy Extend.

Communication

The communication between the operator component and the PLC is performed via a PLC user program. The sequences to be executed for the installation, activation, deactivation and testing of a device are stored in a statement script.

Available devices and device states are displayed in a list. The view of the available devices can be controlled for users according to their access rights.

The subsequent chapters are selected for example only and are not available in every statement list.



Machine manufacturer

Please observe the information provided by the machine manufacturer.

Up to 64 devices can be managed.

References

SINUMERIK 828D Commissioning Manual

23.2 Enabling a device

The available device options may be protected by a password.



Machine manufacturer

Please observe the information provided by the machine manufacturer.

Procedure



1. Select the "Parameter" operating area.



2. Press the menu forward key and then the "Easy Extend" softkey.
A list of the connected devices is displayed.







3. Press the "Enable function" softkey.
The "Enabling of the Devices Option" window opens.



4. Enter the option code and press the "OK" softkey.
A tick appears in the appropriate checkbox in the "Function" column and the function is enabled.

23.3 Activating and deactivating a device

Status	Meaning
	Device activated
	System waiting for PLC checkback signal
	Device faulty
	Interface error in the communication module

Procedure



1. Easy Extend is opened.



2. You can select the desired device in the list with the <Cursor down> or <Cursor up> keys.



3. Position the cursor on the device option for which the function has been unlocked and press the "Activate" softkey.

The device is marked as activated and can now be used.



4. Select the desired activated device and press the "Deactivate" softkey to switch the device off again.

23.4 Initial commissioning of additional devices

Normally, the device has already been commissioned by the machine manufacturer.

You have the option of commissioning the devices subsequently, for example when retrofitting additional devices.

The "Start-up" softkey has been declared as Manufacturer data class (M).

Procedure

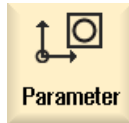

1. Select the "Parameter" operating area.



2. Press the menu forward key and then the "Easy Extend" softkey.

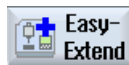

3. Press the "Start-up" softkey.
A new vertical softkey bar appears.



4. Press the "Comm. start-up" softkey to start the commissioning.
Before starting, a complete data backup is made to which you can resort in an emergency.



5. Press the "Cancel" softkey if you want to abort commissioning prematurely.



6. Press the "Restore" softkey to load the original data.
7. Press the "Device function test" softkey to test the machine manufacturer's intended function.

Service Planner (828D only)

24.1 Performing and monitoring maintenance tasks

With the "Service Planner", maintenance tasks have been set up that have to be performed at certain intervals (e.g. top up oil, change coolant).

A list is displayed of all the maintenance tasks that have been set up together with the time remaining until the end of the specified maintenance interval.



The current status can be seen in the status display.

Messages and alarms indicate when a task has to be performed.

Acknowledging a maintenance task

Acknowledge the message when a maintenance task has been completed.

Service Planner

Display	Meaning
Pos	Position of the maintenance task in the PLC interface.
Maintenance task	Name of the maintenance task.
Interval [h]	Maximum time until next servicing in hours.
Remaining time [h]	Time until the interval expires in hours.
Status	Display of the current status of a maintenance task.  The maintenance task has been started.  The maintenance task is completed.  The maintenance task is deactivated.

Procedure



1. Select the "Diagnostics" operating area.



2. Press the menu forward key and then the "Service planner" softkey.
The window with the list of all the maintenance tasks that have been set up appears.



24.1 Performing and monitoring maintenance tasks

**Maintenance
completed**

3. Perform the maintenance task when the maintenance interval has nearly expired or when prompted to do so by alarms or a warning.
4. After you have performed a pending maintenance task and the task is signaled as "Completed", position the cursor at the appropriate task and press the "Servicing performed" softkey.
A message is displayed confirming the acknowledgment, and the maintenance interval is restarted.

Note

You can perform the maintenance tasks before the interval expires. The maintenance interval is restarted.

Edit PLC user program (828D only)

25.1 Introduction

A PLC user program consists to a large degree of logical operations to implement safety functions and to support process sequences. These logical operations include the linking of various contacts and relays. These logic operations are displayed in a ladder diagram.

Editing ladder diagrams

You can edit the ladder diagrams in the Ladder editor.

This allows you to use all the operations supported by the particular PLC type.

Some of the functions differ in scope from that described in the manual.



Machine manufacturer

Please observe the information provided by the machine manufacturer.

References

Further information can be found in the "Function Manual Basic Functions", Chapter P4: PLC for SINUMERIK 828D.

25.2 Displaying and editing PLC properties

25.2.1 Displaying PLC properties

The following PLC properties can be displayed in the "SIMATIC LAD" window:

- Operating state
- Name of the PLC project
- PLC system version
- Cycle time
- Processing time
The processing time can be reset.

You can also update the project data or load a new PLC user program.

Procedure

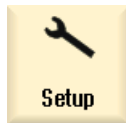

1. Select the "Start-up" operating area.



2. Press the "PLC" softkey.
The ladder diagram representation opens and displays the PLC information.



25.2.2 Resetting the processing time

You can reset the processing time of the PLC user program.

Procedure



1. The Ladder editor is open.



2. Press the "Reset proc. time" softkey.
The data of the processing time is reset.

25.2.3 Loading modified PLC user program

Load the project data to the PLC if some changes have been made to the project data and a new PLC user program is available.

When the project data is loaded, the data classes are saved and loaded to the PLC.

Requirement

Check whether the PLC is in the Stop state.

Note





PLC in the RUN state

If the PLC is in the RUN state, a corresponding message is displayed and the "Load in Stop" and "Load in Run" softkeys appear.

With "Load in Stop", the PLC is set to the Stop state and the project is stored and loaded into the CPU.

With "Load in Run", the loading operation is continued and the PLC project loaded to the PLC. Only those data classes that have actually been changed are loaded, i.e. generally INDIVIDUAL data classes.

Procedure

- | | |
|---|--|
|  | 1. The Ladder editor is open.
You have changed project data. |
|  | 2. Press the "PLC Stop" softkey if the PLC is in the Run state. |
|  | 3. Press the "Load to CPU" softkey to start the loading operation.
All data classes are loaded. |
|  | 4. When the PLC project has been loaded, press the "PLC Start" softkey to switch the PLC to the Run state. |

25.3 Displaying and editing PLC and NC variables

Changes can only be made to the NC/PLC variables with the appropriate password.

 WARNING
Incorrect parameterization
Changes in the states of NC/PLC variables have a considerable influence on the machine. Incorrect configuration of the parameters can endanger life and cause damage to the machine.

In the "NC/PLC Variables" window, enter the NC system variables and PLC variables that you want to monitor or change in the list:

- Variable
Address for NC/PLC variable.
Incorrect variables have a red background and are displayed with a # character in the value column.
- Comment
Any comment on the variables.
The columns can be displayed and hidden.
- Format
Specify the format in which the variable will be displayed.
The format can be specified (e.g. floating point).
- Value
Displays the actual value of the NC/PLC variables.

PLC variables	
Inputs	<ul style="list-style-type: none"> • Input bit (Ex), input byte (EBx), input word (EWx), input double word (EDx) • Input bit (Ix), input byte (IBx), input word (IWx), input double word (IDx)
Outputs	<ul style="list-style-type: none"> • Output bit (Ax), output byte (ABx), output word (AWx), output double word (ADx) • Output bit (Qx), output byte (QBx), output word (QWx), output double word (QDx)
Bit memory	Memory bit (Mx), memory byte (MBx), memory word (MWx), memory double word (MDx)
Times	Time (Tx)
Counters	<ul style="list-style-type: none"> • Counter (Cx) • Counter (Cx)
Data	<ul style="list-style-type: none"> • Data block (DBx): Data bit (DBXx), data byte (DBBx), data word (DBWx), data double word (DBDx) • Data block (VBx): Data bit (VBXx), data byte (VBBx), data word (VBWx), data double word (VBDx)

Formats	
B	Binary
H	Hexadecimal

Formats	
D	Decimal without sign
+/-D	Decimal with sign
F	Floating point (for double words)
A	ASCII character

Notation examples

Permissible notation for variables:

- PLC variables: EB2, A1.2, DB2.DBW2, VB32000002
- NC variables:
 - NC system variables: Notation \$AA_IM[1]
 - User variables / GUD: Notation GUD/MyVariable[1,3]
 - OPI notation: /CHANNEL/PARAMETER/R[u1,2]

Note

If the PLC user program writes a string in an NC/PLC variable, the string will only be displayed correctly if the variable is parameterized as a field variable of the type "A" (ASCII) on the NC side.

Example of a field variable

Variable	Format
DBx.DBBy[<number>]	A

Inserting variables

The start value for "Filter/Search" of variables differs. For example, to insert the variable \$R[0], enter the following start value:

- The start value is 0 if you filter according to "System variables".
- The start value is 1 if you filter according to "All (no filter)". In this case, all signals are displayed and shown in the OPI notation.

The GUD from the machine data is only displayed in the Search window for the variable selection when the associated definition file has been activated. Alternatively, enter the variable you are searching for manually, e.g. GUD/SYG_RM[1]

The following machine data is representative for all variable types (INT, BOOL, AXIS, CHAR, STRING): MD18660 \$MN_MM_NUM_SYNACT_GUD_REAL[1].

Note

- System variables can be dependent on the channel. When the channel is switched over, the values from the selected channel are displayed.
You have the option of having the variable displayed for a specific channel, e.g. \$R1:CHAN1 and \$R1:CHAN2. The values of channel 1 and channel 2 are displayed, irrespective of the channel you are in.
- For user variables (GUD), it is not necessary to specify whether they are global or channel-specific GUD. The first element of a GUD array starts with index 0 as for NC variables.
- Use the tooltip to show the OPI notation for NC system variables (except for GUD).

Servo variables

Servo variables can only be selected and displayed at "Diagnostics" → "Trace".

Changing and deleting values



1. Select the "Diagnostics" operating area.



2. Press the "NC/PLC variables" softkey.

- OR -



1. Select the "Startup" operating area.



2. Press the "PLC" and "NC/PLC variab." softkeys.



The "NC/PLC Variables" window opens.

3. Position the cursor in the "Variable" column and enter the required variable.



4. Press the <INPUT> key.
The operand is displayed with the value.









5. Press the "Details" softkey.
The "NC/PLC Variables: Details" window opens. The information for "Variable", "Comment" and "Value" is displayed in full length.



6. Position the cursor in the "Format" field and select the required format with <SELECT>.

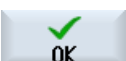

7. Press the "Display comments" softkey.
The "Comments" column is displayed. You have the option of creating comments or editing existing comments.

- | | |
|---|---|
|  | Press the "Display comments" softkey once again to hide the column. |
|  | 8. Press the "Change" softkey if you would like to edit the value.
The "Value" column can be edited. |
|  | 9. Press the "Insert variable" softkey if you wish to select a variable from a list of all existing variables and insert this.
The "Select Variable" window opens. |
|  | 10. Press the "Filter/search" softkey to restrict the display of variables (e.g. to mode group variables) using the "Filter" selection box and/or select the desired variable using the "Search" input box. |
|  | 11. Press the "Delete all" softkey if you would like to delete all the entries for the operands. |
|  | 12. Press the "OK" softkey to confirm the changes or the deletion. |
| | - OR - |
|  | Press the "Cancel" softkey to cancel the changes. |

Editing a variable list

You can edit the variable list using the "Insert line" and "Delete line" softkeys.

- | | |
|---|--|
|  | When you press the softkey, a new line is inserted before the line marked by the cursor.

You can only use the "Insert line" softkey if there is at least one empty line at the end of the variable list.

The softkey is deactivated if there is no empty line. |
|  | When you press the "Delete line" softkey, the line marked by the cursor is deleted.

An empty line will be added at the bottom of the variable list. |

Changing operands

Depending on the type of operand, you increment or decrement the address or address index by one place at a time using the "Operand +" and "Operand -" softkeys.

Note

Axis name as index

If the axis name is the index, the "Operand +" and "Operand -" softkeys have no effect, e.g. \$AA_IM[X1].

Operand
+

Examples

DB97.DBX2.5

Result: DB97.DBX2.6

\$AA_IM[1]

Result: \$AA_IM[2]

Operand
-

MB201

Result: MB200

/Channel/Parameter/R[u1,3]

Result: /Channel/Parameter/R[u1,2]

25.4 Displaying and editing PLC signals in the status list

PLC signals are displayed and can be changed in the "PLC Status List" window.

The following lists are shown

Inputs (IB)

Bit memories (MB)

Outputs (QB)

Variables (VB)

Data (DB)

Setting the address

You can go directly to the desired PLC address to monitor the signals.

Editing

You can edit the data.

Procedure

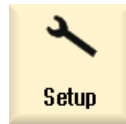

1. Select the "Commissioning" operating area.



2. The Ladder editor is open.



3. Press the "Status list" softkey.
The "Status List" window appears.



4. Press the "Set address" softkey.
The "Set Address" window appears.



5. Activate the desired address type (e.g. DB), enter the value and press the "Accept" softkey.
The cursor jumps to the specified address.



6. Press the "Change" softkey.
The "RW" input field can be edited.



7. Enter the desired value and press the "Accept" softkey.

25.5 View of the program blocks

25.5.1 Displaying information on the program blocks

You can display all the logic and graphic information of a program block.

- Logic information
The following information is displayed in a ladder diagram (LAD):
 - Networks with program parts and current paths
 - Electrical current flow through a number of logical operations
- Select program block
Select the program block that you want to display.
- Program status
You call information about the program status.
- Symbolic address
You select between specification in absolute or symbolic address.
- Zoom
You can enlarge or reduce the ladder diagram.
- Search
You can use the "Search" function to go directly to a position in the PLC user program that you wish to edit, for example.
- Edit
You can insert, edit or delete networks.
- Symbol information
You can display all symbolic identifiers used in the selected network.

Procedure

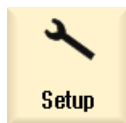

1. Select the "Startup" operating area.



2. Press the "PLC" softkey.



3. Press the "Window 1" or "Window 2" softkey.

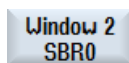

25.5.2 Structure of the user interface

The following figure shows the user interface.

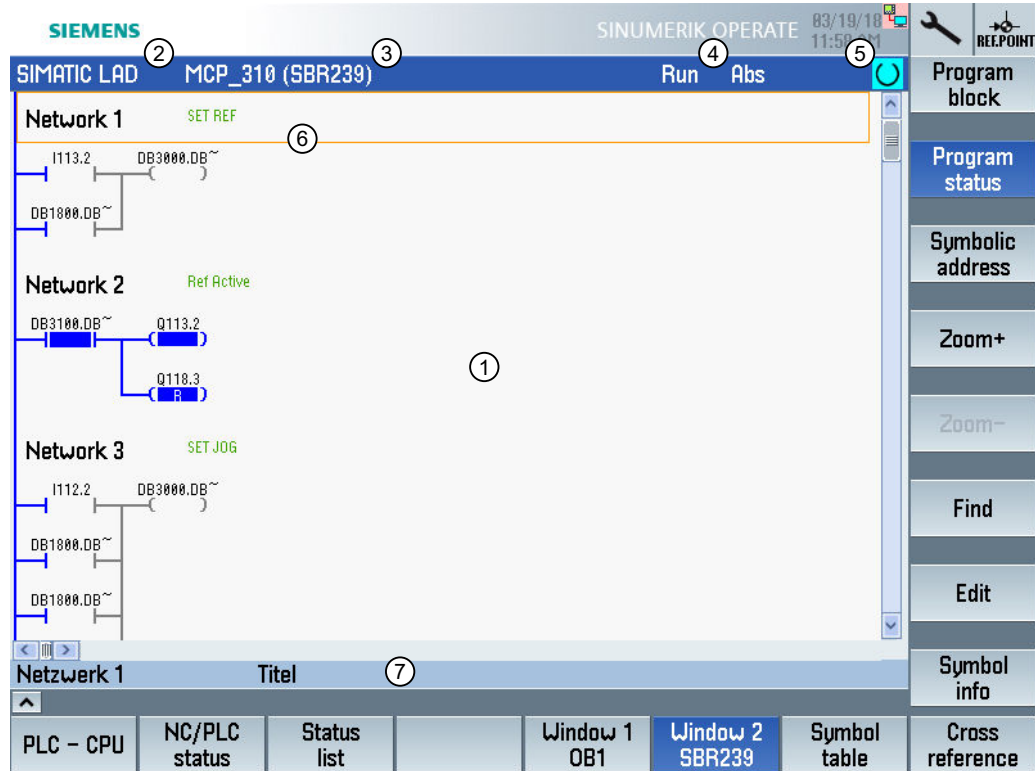



Figure 25-1 Screen layout

Table 25-1 Key to screen layout

Screen element	Display	Meaning
1	Application area	
2	Supported PLC program language "LAD"	
	LAD*	Program change exists
3	Name of the active program block	
	Representation: Symbolic name (absolute name)	
4	Program status	
	Run	Program is running
	Stop	Program is stopped
	Status of the application area	
	Sym	Symbolic representation
	Abs	Absolute representation
5	Display of the active keys (<INPUT>, <SELECT>)	
		











Screen element	Display	Meaning
6	Focus	Performs the tasks of the cursor
7	Information line	Displays information, e.g. for searching











25.5.3 Control options

In addition to the softkeys and the navigation keys, there are further shortcuts in this area.

Shortcuts

The cursor keys move the focus over the PLC user program. When the window borders are reached, scrolling is performed automatically.

Shortcuts	Action
	To the first column of the row
CTRL 	
END	To the last column of the row
CTRL 	
	Up a screen
	Down a screen
 	One field to the left, right, up or down
 	
CTRL 	To the first field of the first network
- OR -	
CTRL 	

Shortcuts		Action
		To the last field of the last network
- OR -		
		
		Open the next program block in the same window
		Open the previous program block in the same window
		The function of the Select key depends on the position of the input focus. <ul style="list-style-type: none"> • Table row: Displays the complete text row • Network title: Displays the network comment • Command: Displays all operands
		If the input focus is positioned on a command, all operands including the comments are displayed.

25.5.4 Displaying the program status

You can display the program status.

The following Information is displayed:

- Program status: "Run" or "Stop"
- Status of the application area: "Sym" or "Abs"

Displaying the program status

If your PLC has the "Progress status" function, the status values as well as the information flow are displayed at the time of execution of the operations. The status of the local data memory and the accumulators is also displayed.

The "Progress status" display is also controlled using the "Program stat." softkey

Colors for displaying the program status



In the progress status, different colors are used to display information.

Display	Color
Signal flow of the busbar when the status is active	Blue
Signal flow in the networks	Blue
All operations that are active and that are executed without error (corresponds to the signal flow)	Blue
Status of the Boolean operations (corresponds to the signal flow)	Blue
Timers and counters active	Green
Error during execution	Red

25.5 View of the program blocks

No signal flow	Gray
No network executed	Gray
STOP operating state	Gray

Procedure



-  1. The program block view is open.
-  2. Press the "Program stat." softkey to display the program status display in the status display.
-  3. Press the "Program stat." softkey again to hide the program status display in the status display again.

25.5.5 Changing the address display

You can choose between specification in absolute or symbolic address.

Elements for which there are no symbolic identifiers are automatically displayed with absolute identifiers.

Procedure

-  1. The program block view is open.
-  2. Press the "Symbol. address" softkey.
The list of operands is displayed sorted according to symbolic address.
-  3. To return to the display showing the absolute addresses press the "Symbol. address" softkey again.

25.5.6 Enlarging/reducing the ladder diagram

You can enlarge or reduce the representation of the ladder diagram.

Procedure



1. The program block view is open.



2. Press the "Zoom +" softkey to enlarge the section of the ladder diagram. After enlarging, the "Zoom -" softkey is available.



3. Press the "Zoom -" softkey to reduce the section of the ladder diagram again.

25.5.7 Program block

25.5.7.1 Displaying and editing the program block

You can create and edit program blocks and display further information as follows:

- Local variables
You can display local variables of a block.
- Create new program block
You can create a new program block.
- Open program block
You can display all the logic and graphical information of the program block and you can edit the block.
- Properties
You can display the properties of a block and edit them, when required.
- Protection
You can protect the block with a password. Then, the block cannot be opened without entering the password.



Machine manufacturer

Please observe the information provided by the machine manufacturer.

Procedure

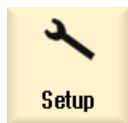



1. Select the "Startup" operating area.



2. Press the "PLC" softkey.

25.5 View of the program blocks

- | | | |
|---|----|---|
|  | 3. | Press the softkey: |
|  | | <ul style="list-style-type: none">• "Window 1 OB1"- OR -• "Window 2 SBRO" |
|  | 4. | Press the "Program block" softkey. |

25.5.7.2 Displaying local variable table

You have the option of displaying the local variable table of a block.

The following information is listed in the tables.

Name	Freely assigned
Variable type	Selection: <ul style="list-style-type: none">• IN• IN_OUT• OUT• TEMP
Data type	Selection: <ul style="list-style-type: none">• BOOL• BYTE• WORD• INT• DWORD• DINT• REAL
Comment	Freely assigned

Procedure

- | | | |
|---|----|---|
|  | 1. | The "Program Block" window is open. |
| | 3. | Press the "Local variables" softkey. |
| | | The "Local Variables" window appears and lists the created variables. |

25.5.7.3 Creating a program block

Overview

Using the Ladder editor, you can perform a PLC diagnosis to find fault causes or program errors.

If an input or output fails, a disturbance in the plant could result, making modifications to the PLC user program necessary. For this, you can create additional program blocks.

Creating a program block

If program blocks are missing, you can add them via the vertical softkey bar. You can also delete blocks via the vertical softkey bar. You can also modify the networks of interrupt routines and subprograms on the control and save and load your changes.

Marshalling data

You can "rewire" inputs (via INT_100) or outputs (via INT_101) for service purposes.

Note

Saving the PLC project when changing the operating area

If you have created blocks or inserted, removed, or edited networks in a block, you must save the project before you change from the PLC area to another operating area. Transfer the project to the PLC using the "Load to CPU" softkey. If this is not done, all of the changes will be lost and must be re-entered.

Please take the appropriate program note into consideration.



Machine manufacturer

Please observe the information provided by the machine manufacturer.

Creating a new block

You create new program blocks in the Ladder editor.

Name	SBR, INT_100, INT_101, INT_0 The number from the selection field "Number of subprogram" is taken for the name of the INT block.
Author	Maximum 48 characters are permitted.
Number of subprogram	You must select a free subprogram number between 0 and 255. For INT100, INT101, and INT0, the field is filled automatically and cannot be edited.
Data class	Individual / Manufacturer This data class is automatically filled by the system and cannot be edited.
Comment	Maximum 100 lines and 4096 characters are permitted.

Note

Access protection

You have the option of protecting blocks that have been newly created against being accessed.

Procedure



1. The "Program Block" window is open.
2. Press the "New" softkey.
The "Properties" window opens.
3. Select a block and enter the name of the author, the number of the sub-program and, if relevant, a comment.



Note:

To insert a line break, use the key combination <Alt> + <INPUT>. When you have completed your entries, press the "Accept" softkey.

25.5.7.4 Opening a program block in the window

You can display all the logic and graphical information of a program block.

Procedure



1. The relevant block is selected and the "Program Block" window is open.
2. Select the desired block and press "Open".



The block is displayed in the currently active window 1 or window 2.

25.5.7.5 Displaying/canceling the access protection

You can password protect your program organizational units (POUs) in the PLC 828 programming tool. This prevents other users from accessing this part of the program. This means that it is invisible to other users and is encrypted when it is downloaded.

A lock symbol is used to show a password-protected POU in the block overview and in the ladder diagram.

Procedure



1. The relevant block is selected and the "Program Block" window is open.
2. Press the "Protection" softkey.
The "Protection" window opens.

Removing protection

3. Enter the password.
 - "This program block remains protected" is activated:
You have the option of editing or deleting the block. Protection is reactivated when you load the PLC user program to the PLC.
 - "This program block remains protected" is deactivated:
Block protection is permanently withdrawn. After being loaded to the PLC, the PLC user program is not protected.

Setting protection

4. Enter the required password in the first line "Please enter password" and re-enter the password in the second line.
5. Activate the "Protect all program blocks using this password" checkbox, if you wish to protect all of the user program blocks.

Note:

Program blocks that are already password-protected are not affected.



6. Press the "Accept" softkey.

25.5.7.6 Editing block properties subsequently

You can edit the title, author and comments of a block.

Note:

To insert a line break in comment, use the key combination <ALT> + <INPUT>.

Note

Block names, subprogram names and data class assignments cannot be edited.

Procedure



1. The relevant block is selected and the "Program Block" window is open.
2. Press the "Properties" softkey.
The "Properties" window appears.

25.5.8 Editing a program block

25.5.8.1 Editing the PLC user program

You can change and extend PLC user programs.

All the operations supported by the PLC type are available for the editing. Subprograms and interrupt programs can be added and deleted.

Note

Saving changes

If you make changes in the program, you must save the project before you change from the PLC area to another operating area. You can transfer the project to the PLC using the "Load to CPU" softkey. If this is not done, all of the changes will be lost and must be re-entered.

Please note the corresponding program information:

Editing functions

- Edit block
 - Create connecting lines, contacts, coils, and boxes
 - Change operands
 - Delete operations
- Network
 - Create
Create and then edit a new network
 - Edit
Subsequently edit networks
 - Delete
Delete networks

References

For information, please refer to the Basic Functions Function Manual, Chapter P4: PLC for SINUMERIK 828D

25.5.8.2 Editing a program block

You can edit program blocks.







Requirement

Before you can edit program blocks, the program status must have stopped.

If the status is active, you will receive a message that the program status must have stopped.

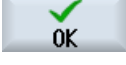
1. To stop the program status automatically, press the "OK" softkey.
- OR -
To stop the program status, press the "Program stat." softkey again.

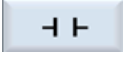
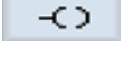
Procedure

- | | |
|---|--|
|  | 1. The ladder logic display (LAD) is open. |
|  | 2. Press the "Program block" softkey and select the block that you want to edit. |
|  | 3. Press the "Open" softkey.
The program block is opened in the appropriate window. |
|  | 4. Press the "Change" softkey to open the editing mode.
If the program status display is active, a message is displayed that you can confirm with "OK". |
|  | 5. If you want to insert connecting lines, position the cursor at the desired position and press the appropriate softkey, e.g. "-->". |
|  | - OR -
Press the "Contacts" softkey and select the desired operation in the list that opens. |
|  | - OR -
Press the "Coils" softkey and select the desired operation in the list that opens. |
|  | - OR -
Press the "Boxes" softkey and select the desired operation in the list that opens. |
|  | 5. Press the "Accept" softkey to confirm the respective action.
The changes will now be saved. |
- Note:**
The changes only take effect when the user program is loaded to the CPU.



Note

Save changes

If you make changes in the program, you must save the project before you change from the PLC area to another operating area. You can transfer the project to the PLC using the "Load to CPU" softkey. If this is not done, all of the changes will be lost and must be re-entered.

Please note the corresponding program information:

Loading the program to the CPU

- | | |
|---|---|
|  | 1. Press the "PLC-CPU" and "Load to CPU" softkeys. |
|  | |
|  | 2. Press the "OK" softkey to start the load operation.
After the error-free compilation of the program, the PLC is switched to the STOP state and loaded into the PLC. |

25.5.8.3 Deleting a program block

You can delete program blocks.

Procedure



1. The relevant block is selected and the "Program Block" window is open.
2. Select the block and press "Delete".

5. Press "OK" to delete the block.

- OR -

Press "Cancel" to abort the action.



Machine manufacturer

Please observe the information provided by the machine manufacturer.

25.5.8.4 Inserting and editing networks

You can create a new network and then insert operations (bit operation, assignment, etc.) at the selected cursor position.



Machine manufacturer

Please observe the information provided by the machine manufacturer.

The bit combinations comprise one or several logical operations and the assignment to an output / bit memory.

If the cursor is moved further to the left with the arrow key, the type of assignment or a logic operation can be selected. A further logic operation cannot be placed to the right of an assignment. A network must always be terminated with an assignment.







Procedure



1. A block is selected.
2. Press the "Edit" softkey.
3. Position the cursor on a network.
4. Press the "Insert network" softkey.

- OR -

Press the <INSERT> key.

- If the cursor is positioned on "Network x", a new, empty network is inserted behind this network.
5.  Position the cursor on the desired element below the network title and press the "Insert operation" softkey.
The "Insert Operation" window appears.
 6.  Select a bit operation and press the "OK" softkey.
 7.  Press the "Insert operand" softkey.
 8.  Enter the logic operation or the command and press the <INPUT> key to complete the entry.
 9.  Position the cursor on the operation that you want to delete and press the "Delete operation" softkey.
- OR -
 Position the cursor on the title of the network that you want to delete and press the "Delete network" softkey.
- OR -
 Press the key.
- The network, including all the logic operations and operands and/or the selected operation is deleted.





25.5.8.5 Editing network properties

You can edit the network properties of a block.

Network title and network comment

The title can have a maximum of 3 lines and 128 characters. The comment must not contain more than 100 lines and 4096 characters.

Procedure

1.  The ladder diagram display (LAD) is open.
2.  Use the cursor keys to select the network that you want to edit.



25.5 View of the program blocks



3. Press the <SELECT> key.
The "Network Title / Comment" window opens and shows the title and a possibly assigned comment for the selected network.



5. Press the "Change" softkey.
The fields can be edited.

Note:

To insert a line break in comment, use the key combination <ALT> + <INPUT>.



6. Enter the changes and press the "OK" softkey to transfer the data to the user program.

25.5.9 Displaying the network symbol information table

All of the symbolic identifiers used in the selected network are displayed in the "Network Symbol Information Table" window.

The following information is listed:

- Names
- Absolute addresses
- Comments

The symbol information table remains empty for networks that do not contain any global symbols.

Procedure



1. The ladder diagram display (LAD) is open.



2. Select the desired network and press the "Symbol info" softkey.
The "Network Symbol Information Table" window appears.



3. Use the cursor keys to move within the table.



25.6 Displaying symbol tables

You can display the symbol tables that are used to obtain an overview of the global operands available in the project.

The name, address and possibly also a comment is displayed for each entry.

Procedure



1. The Ladder editor is open.



2. Press the "Symbol table" and "Sym. tab. selection" softkeys. The list with the symbol table entries is displayed.



3. Select the desired table and press the "Open" softkey. The table is displayed.



4. Use the cursor keys to select the desired entry.



25.7 Displaying cross references

You can display all the operands used in the PLC user project and their use in the list of cross-references.

This list indicates in which networks an input, output, bit memory, etc. is used.

The list of cross references contains the following information:

- Block
- Address in the network
- Context (command ID)

Symbolic and absolute address











You can select between specification in absolute or symbolic address.

Elements for which there are no symbolic identifiers are automatically displayed with absolute identifiers.

Opening program blocks in the ladder diagram

From the cross references, you can go directly to the position in the program where the operand is used. The corresponding block is opened in window 1 or 2 and the cursor is set on the corresponding element.

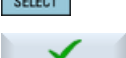
Procedure

- | | |
|---|--|
|  | 1. The Ladder editor is open. |
|  | 2. Press the "Cross refs." softkey.
The list of cross references opens and the operands are displayed sorted according to absolute address. |
|  | 3. Press the "Symbol. address" softkey.
The list of operands is displayed sorted according to symbolic address. |
|  | 4. Press the "Absolute address" softkey to return to the display showing the absolute addresses. |
|  | 5. Select the desired cross reference and press the "Open in window 1" or "Open in window 2" softkey. |
|  | The ladder diagram is opened and the selected operand is marked. |
|  | 6. Press the "Find" softkey.
The "Find / Go To" window opens. |
|  | 7. Select "Find operand" or "Go to" and enter the sought element or the desired line and select the search order (e.g. search up). |
|  | 8. Press the "OK" softkey to start the search. |
|  | 9. If an element is found that corresponds to the sought element, but is not at the appropriate position, press the "Find next" softkey to find where the search term occurs next. |

25.8 Searching for operands

Use the search function in very large PLC user programs to go directly to a position that you wish to edit, for example.







Restricting the search

- "Window 1" / "Window 2"
With "Go to", you can jump directly to the desired network.
- "Cross references", "Symbol table"
With "Go to", you can jump directly to the desired line.

Requirement

Window 1 / window 2, the symbol tables or the list of cross references is open.

Procedure

- | | |
|---|---|
|  | 1. Press the "Find" softkey.
A new vertical softkey bar appears. The "Find / Go To" window opens at the same time. |
|  | 2. Select the "Find operand" entry in the first input field if you are searching for a specific operand and enter the search term in the "Find" input field. |
|  | 3. Select the search range (e.g. Find all). |
|  | 4. Select the "In this program unit" or "In all program units" entry if you are in "Window 1" or "Window 2" or in the symbol table in order to restrict the search. |
|  | 5. Press the "OK" softkey to start the search.
If the operand you are searching for is found, the corresponding line is highlighted. |
|  | Press the "Continue search" softkey if the operand found during the search does not correspond to the element you are looking for. |
|  | - OR -
Press the "Cancel" softkey if you want to cancel the search. |

Appendix

A

A.1 840D sl / 828D documentation overview

A.1 840D sl / 828D documentation overview

General documentation



Advertising brochure
- SINUMERIK 840D sl
- SINUMERIK 828D
- SINUMERIK 828D BASIC



Catalog NC 62
SINUMERIK 840D sl



Catalog NC 82
SINUMERIK 828D



Catalog PM 21
SIMOTION,
SINAMICS S120



Configuration Manual
- EMC installation guideline
- Industrial security



System Manual
Ctrl-Energy

User documentation

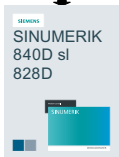

Operating Manual
- Universal
- Turning
- Milling
- Grinding



Programming Manual
- Fundamentals
- Job Planning
- Measuring Cycles



Programming Manual
- ISO Turning
- ISO Milling



Diagnostics Manual
Alarms



Diagnostics Manual
Alarms

Manufacturer/Service documentation



Equipment Manual
- NCU
- Operator components and networking
- ADI4



Equipment Manual
Commissioning Manual
Service Manual



Commissioning Manual
- CNC: NCK, PLC, Drive
- Base software and operating software



Lists Manual
- Machine data
- Interface signals
- Variables



Lists Manual
- Machine data
- Interface signals
- Parameters
- Variables



System Manual
Guidelines for configuring machines

Manufacturer/Service documentation



Function Manual
- Basic functions
- Extended Functions
- Special Functions
- Synchronized Actions
- ISO Dialects



Function Manual
Tool management



Function Manual
Safety Integrated



Function Manual
Safety Integrated

Info / Training



Training documentation
- Simple milling with ShopMill
- Simple turning with ShopTurn



Manual
Tool and mold making

Electronic documentation



DOConCD



Industry Online Support (SIOS)



Industry Mall

Index

"

- "SINUMERIK Operate Gen. 2"
 - Multitouch panel, 69
- "SINUMERIK Operate Generation 2" user interface
 - Touch operator controls, 75
- "SINUMERIK Operate Generation 2" user interface, 69
 - Function key block, 74
 - Virtual keyboard, 76

2

- 2-channel grooving, 691
- 2-channel plunge turning, 691
- 2-channel stock removal, 691

A

- ABC keyboard, 82
- Absolute dimensions, 290
- Access protection
 - Program block, 946
- Actual-value display, 45
- Adapter-transformed view, 753
- Advanced Surface, 211
- Alarm log
 - display, 826
 - Sorting, 828
- Alarms
 - Backing up log data, 823
 - cancel, 824
 - Displaying, 823
 - Sorting, 828
- Align turning tool - CYCLE800
 - Function, 604
 - Parameter, 606
- Aligning milling tool - CYCLE800
 - Function, 604
 - Parameter, 607
- Any file, 779
- Approach/retraction cycle
 - Parameters, 318, 319
 - ShopTurn program, 318
- Arbitrary positions - CYCLE802
 - Function, 380
 - Parameter, 384

Archive

- Generate in the program manager, 806
- generating in the system data, 807
- Punched tape format, 806
- read in archive from system data, 810
- reading-in in the Program Manager, 809

Auxiliary functions

- H functions, 212
- M functions, 212

Axes

- Defined increment, 138
- Direct positioning, 140
- Referencing, 90
- Repositioning, 159
- Traversing, 138
- Variable increment, 139

B

B axis

- Alignment angle, 866
- Approach/retraction, 870
- Function, 863
- Measure tool, 875
- Milling, 867
- Position pattern, 872
- Swiveling, 868

Backing up

- Data - in the Program Manager, 806
- Data - via the system data, 807
- Parameter, 816

Base offset, 112

- Basic blocks, 155
- Binary format, 806

Blank input

- Function, 265
- Parameter, 267, 666
- Simultaneous recording, 246

Block

- Search, 161
- Searching - interruption point, 163
- Searching - search pointer, 163

Block search

- Coolant, 720
- Mode, 165
- Multi-channel view, 689
- Position pattern, 167
- Program interruption, 163
- Search pointer, 163

- Search target parameters, 164, 165
- Search target specification, 162
- ShopTurn program, 167
- Using, 160
- Boring - CYCLE86
 - Function, 349
 - Parameter, 351
- C**
- Calculator
 - Fits, 446
- Center drilling
 - Function, 615
 - Input simple, 615
 - Parameter - input complete, 617
 - Parameter - input simple, 618
- Centering - CYCLE81
 - Function, 340
 - Parameter, 342
- Channel switchover, 95
- Chuck dimensions, 121
- Circle, 627
 - Manual Machine, 853
- Circle position pattern - HOLES2
 - Parameter, 394
- Circle position pattern – HOLES2
 - Function, 391
- Circular pocket - POCKET4
 - Function, 491
 - Input simple, 491
 - Parameter - input complete, 496
 - Parameter - input simple, 497
- Circular spigot - CYCLE77
 - Function, 506
 - Input simple, 507
 - Parameter - input complete, 510
 - Parameter - input simple, 510
- Circumferential slot - SLOT2
 - Function, 526
 - Input simple, 527
 - Parameter - input complete, 531
 - Parameter - input simple, 531
- Clamping the spindle, 293
- Coarse and fine offsets, 112
- Code carrier connection, 728
- Collision avoidance, 701
 - Displaying the machine model (kinematic chains), 703
 - Machine operating area, 704
 - Settings, 704
- Context-sensitive online help, 66
- Contour call - CYCLE62
 - Function, 448, 567
 - Parameter, 449, 568
- Contour elements, 437, 557
- Contour pocket residual material - CYCLE63
 - Function, 586
 - Parameter, 588
- Contour spigot residual material - CYCLE63
 - Function, 593
 - Parameter, 596
- Contour turning
 - Manual machine, 859
 - Overview, 436
 - Retraction planes, 436
- Contours
 - Programming, 436
- Coolant
 - Block search, 720
 - Tool change, 720
- Coordinate system
 - Switching over, 96
 - Transforming, 621
- Coordinate transformation
 - Functions, 621
 - Mirroring - function, 625
 - Mirroring - parameter, 626
 - Offset - function, 623
 - Offset - parameter, 623
 - Rotation - function, 624
 - Rotation C axis - function, 626, 627
 - Scaling - function, 625
 - Scaling - parameter, 625
- Counter-spindle, 122
- Counterspindle, fixed
 - Function, 647
 - Parameter, 648
- Counter-spindle, traversable
 - Function, 639
 - Parameter, 643, 644, 645
- Cross-references, 954
 - displaying operands, 954
- Ctrl-Energy
 - Comparing usage values, 908
 - Displaying measured curves, 907
 - Displaying usage values, 908
 - Energy analysis, 904, 905
 - Energy-saving profiles, 911
 - Functions, 903
 - Measuring the energy consumption, 906
 - Saved measuring curves, 907, 908

- Cut-off - CYCLE92
 - Function, 434
 - Parameter, 435
- Cutting edge numbers, 720
- Cutting edge width, 719
- Cutting tip length, 719
- Cutting tip width, 719
- CYCLE60 - Engraving
 - Function, 551
 - Parameter,
- CYCLE61 - Face milling
 - Parameter, 481
- CYCLE61- Face milling
 - Function, 478
- CYCLE62- contour call
 - Function, 448, 567
 - Parameter, 449, 568
- CYCLE63 - Contour pocket residual material
 - Function, 586
 - Parameter, 588
- CYCLE63 - Contour spigot residual material
 - Function, 593
 - Parameter, 596
- CYCLE63 - Milling contour pocket
 - Function, 581
 - Input simple, 581
 - Parameter - input complete, 584
 - Parameter - input simple, 584
- CYCLE63 - Milling contour spigot
 - Function, 589
 - Input simple, 589
 - Parameter - input complete, 591
 - Parameter - input simple, 592
- CYCLE64 - Predrilling contour pocket
 - Function - Centering, 576
 - Function - Predrilling, 576
 - Parameter - Centering, 579
 - Parameter - Predrilling, 580
- CYCLE70 - thread milling
 - Function, 546
 - Parameters, 548
- CYCLE72 - Path milling
 - Function, 568
 - Parameter, 574
- CYCLE76 - Rectangular spigot
 - Function, 500
 - Input simple, 500
 - Parameter - input complete,
 - Parameter - input simple,
- CYCLE77 - circular spigot
 - Function, 506
 - Input simple, 507
- Parameter - input complete, 510
- Parameter - input simple, 510
- CYCLE78 - Drill thread milling
 - Function, 375
 - Parameters, 378
- CYCLE79 - multi-edge
 - Function, 512
 - Input simple, 513
 - Parameter - input complete, 515
 - Parameter - input simple, 515
- CYCLE800 - align turning tool
 - Function, 604
 - Parameter, 606
- CYCLE800 - Aligning milling tool
 - Function, 604
 - Parameter, 607
- CYCLE800 - Setting milling tool
 - Function, 607
 - Parameter, 609
- CYCLE800 - Swiveling
 - Function, 597
 - Parameter, 604
- CYCLE801 - frame position pattern
 - Function, 387
 - Parameter, 390
- CYCLE801 - grid position pattern
 - Function, 387
 - Parameter, 389
- CYCLE802 - arbitrary positions
 - Function, 380
 - Parameter, 384
- CYCLE81 - centering
 - Function, 340
 - Parameter, 342
- CYCLE82 - drilling
 - Function, 342
 - Input simple, 342
 - Parameter - input complete, 345
 - Parameter - input simple, 345
- CYCLE83 - deep-hole drilling 1
 - Function, 351
 - Input simple, 352
 - Parameter - input complete, 353, 355
 - Parameter - input simple, 355
- CYCLE830 - Deep-hole drilling 2
 - Function, 357
 - Hole entry, 358
 - Input simple, 357
 - Parameter - input complete,
 - Parameter - input simple,
 - Through drilling,

- With pilot hole, 358
- With/without predrilling, 358
- CYCLE832 - High Speed Settings
 - Function, 609
 - Parameters, 612
- CYCLE84 - tapping without compensating chuck
 - Function, 367
 - Input simple, 368
 - Parameter - input complete, 373
 - Parameter - input simple, 373
- CYCLE840 - tapping with compensating chuck
 - Function, 367
 - Input simple, 368
 - Parameter - input complete, 373
 - Parameter - input simple, 373
- CYCLE85 - reaming
 - Function, 346
 - Parameter, 348
- CYCLE86 - boring
 - Function, 349
 - Parameter, 351
- CYCLE899 - open slot
 - Function, 534
 - Input simple, 535
 - Parameter - input complete, 542
 - Parameter - input simple, 542
- CYCLE92 - cut-off
 - Function, 434
 - Parameter, 435
- CYCLE930 - groove
 - Function, 403
 - Parameter, 405
- CYCLE940 - Undercut
 - Function - DIN thread, 408
 - Function - Form E, 406
 - Function - Form F, 406
 - Function - Thread, 408
 - Parameter - DIN thread, 409
 - Parameter - Form E, 407
 - Parameter - Form F, 408
 - Parameter - Thread, 410
- CYCLE951 - stock removal
 - Function, 400
 - Parameter, 403
- CYCLE952 - Grooving
 - Function, 461
 - Input simple, 463
 - Parameter - input complete, 465
 - Parameter - input simple, 467
- CYCLE952 - Grooving residual material
 - Function, 467
 - Parameters, 469
- CYCLE952 - Plunge turning
 - Function, 469
 - Input simple, 471
 - Parameter - input complete, 473
 - Parameter - input simple, 476
- CYCLE952 - Plunge turning residual material
 - Function, 476
 - Parameters, 477
- CYCLE952 - Stock removal
 - Function, 449
 - Input simple, 453
 - Parameter - input complete, 456
 - Parameter - input simple, 459
- CYCLE952 - Stock removal residual material
 - Function, 459
 - Parameters, 461
- CYCLE98 - thread chain
 - Function, 428
 - Input simple, 429
 - Parameter - input complete, 432
 - Parameter - input simple, 434
- CYCLE99 - Thread turning
 - Function - Face thread, 411
 - Function - Longitudinal thread, 411
 - Function - Tapered thread, 411
 - Input simple, 411
 - Parameter - Input complete - face thread, 426
 - Parameter - Input complete - longitudinal thread, 416
 - Parameter - Input complete - tapered thread, 421
 - Parameter - Input simple- face thread, 428
 - Parameter - Input simple- longitudinal thread, 418
 - Parameter - Input simple- tapered thread, 423
- Cycles
 - Current levels, 262
 - Hiding cycle parameters, 273
 - Screen forms, 262

D

- Data block (SB2), 152
- Deep-hole drilling 1 - CYCLE83
 - Function, 351
 - Input simple, 352
 - Parameter - input complete, 353
 - Parameter - input simple, 355
- Deep-hole drilling 2 - CYCLE830
 - Function, 357
 - Hole entry, 358
 - Hole exit, 359
 - Input simple, 357
 - Parameter - input complete, 364

- Parameter - input simple, 364
 - Through drilling, 358
 - With pilot hole, 358
 - With/without predrilling, 358
 - Dictionary
 - Importing, 61
 - Directory
 - Copying, 789
 - Creating, 776
 - Deleting, 791
 - Highlight, 787
 - Inserting, 789
 - Naming convention, 776
 - Properties, 792
 - Selecting, 787
 - Display Manager
 - Operator controls, 86
 - DRF (handwheel offset), 169
 - Drill thread milling - CYCLE78
 - Function, 375
 - Parameters, 378
 - Drilling
 - Manual Machine, 856
 - Drilling - CYCLE82
 - Function, 342
 - Input simple, 342
 - Parameter - input complete, 345
 - Parameter - input simple, 345
 - Drilling radius, 719
 - Drives
 - Logical drive, 794
 - Setting up, 794
 - DRY (dry run feed), 169
 - Duplo number, (See replacement tool number)
 - DXF file
 - Changing the section, 188
 - Cleaning, 186
 - close, 186
 - Delete Element, 193
 - Delete range, 192
 - Importing and editing in the Editor, 190
 - Increasing / decreasing the section, 187
 - Machining plane, 191
 - Open, 186
 - Rotating the drawing, 188
 - Saving, 193
 - Select contour and accept, 196
 - Select the machining range, 192
 - Selecting drilling position, 194
 - Snap radius, 191
 - Specifying a reference point, 190
 - Transferring the drilling position, 194
 - Zero point, 190
 - DXF-Reader, 186
- ## E
- Easy Extend
 - Activate/deactivate device, 925
 - Additional devices, 923
 - Enabling a device, 924
 - First commissioning of the additional devices, 926
 - Easy Message, 913
 - Commissioning, 914
 - Settings, 921
 - User log on/off, 919
 - Editor
 - Calling, 174
 - Settings, 182
 - EES (execution from external storage), 797
 - Elongated hole - LONGHOLE
 - Function, 544
 - Parameter, 546
 - Enabling button, 894
 - Energy analysis
 - Details, 905
 - Displaying, 905
 - Long time measurement, 909
 - Energy consumption
 - Displaying, 904
 - Measuring, 906
 - Energy-saving profiles, 911
 - Engraving - CYCLE60
 - Function, 551
 - Parameter, 556
 - Equipping tools
 - Multitool, 758
 - EXTCALL call, 803
- ## F
- Face milling - CYCLE61
 - Function, 478
 - Parameter, 481
 - Feed data
 - Actual value window, 47
 - Finger gestures, 71
 - Fit calculator
 - Master dimension programming, 446

Frame position pattern - CYCLE801
 Function, 387
 Parameter, 390
 FTP drive, 770
 Function key block
 "SINUMERIK Operate Generation 2" user
 interface, 74

G

G code program
 Blank input, 265
 Creating, 778
 Programming variables, 274
 G functions
 Display all G groups, 211
 Displaying selected G groups,
 Mold making, 211
 GCC (G code converter), 169
 Global R parameters, 200
 Global user variables, 203
 Gloves, 70
 Grid position pattern - CYCLE801
 Function, 387
 Parameter, 389
 Groove - CYCLE930
 Function, 403
 Parameter, 405
 Grooving - CYCLE952
 Function, 461
 Input simple, 463
 Parameter - input complete, 465
 Parameter - input simple, 467
 Grooving residual material - CYCLE952
 Function, 467
 parameters, 469

H

Handheld terminal 8, 893
 Handwheel
 Assigning, 126
 High Speed Settings - CYCLE832
 Function, 609
 Parameters, 612
 Highlight
 Directory, 787
 Program, 787
 HOLES1 - row position pattern
 Parameter, 386

HOLES1 – row position pattern
 Function, 384
 HOLES2 - circle position pattern
 Parameter, 394
 HOLES2 – circle position pattern
 Function, 391
 HOLES2 - position pattern pitch circle
 Parameter, 397
 HOLES2 – position pattern pitch circle
 Function, 391
 HT 8
 Enabling button, 894
 Overview, 893
 Touch Panel, 901
 Traversing keys, 896
 User menu, 897
 Virtual keyboard, 899

I

IME
 Chinese characters, 57
 Korean characters, 62
 Incremental dimensions, 290
 Input simple
 Center drilling, 615
 Circular pocket - POCKET4, 491
 Circular spigot - CYCLE77, 507
 Circumferential slot - SLOT2, 527
 CYCLE830 - Deep-hole drilling 2, 357
 CYCLE99 - Thread turning, 411
 Deep-hole drilling 1 - CYCLE83, 352
 Drilling - CYCLE82, 342
 Grooving - CYCLE952, 463
 Longitudinal slot - SLOT1, 518
 Milling contour pocket - CYCLE63, 581
 Milling contour spigots - CYCLE63, 589
 Multi-edge - CYCLE79, 513
 Open slot - CYCLE899, 535
 Plunge turning - CYCLE952, 471
 Rectangular pocket - POCKET3, 482
 Rectangular spigot - CYCLE76, 500
 Stock removal - CYCLE952, 453
 Tapping with compensating chuck -
 CYCLE840, 368
 Tapping without compensating chuck -
 CYCLE84, 368
 Thread chain - CYCLE98, 429
 Interruption point
 Approaching, 163

J

- Job list, 780
 - Multi-channel support, 664

K

- Key combinations - Simulation
 - Changing the section, 252
 - Enlarging/reducing a graphic, 250
 - Feedrate, 248
 - Moving the graphic, 251
 - Override, 248
 - Rotating the view, 251
 - Single block mode, 249

L

- Ladder editor
 - Editing the PLC user program, 929
- Layer selection, 186
- Limit
 - Grooving - CYCLE952, 462
 - Plunge turning - CYCLE952, 470
 - Stock removal - CYCLE952, 452
- Limit stops, 849
- Local drive, 768
 - Creating an NC directory, 768
- Local variable tables, 944
- Logbook
 - Delete entries, 838
 - Displaying, 837
 - Edit the address data, 837
 - Entry search, 839
 - Making an entry, 838
 - Output, 836
 - Overview, 837
- Long time measurement
 - Energy analysis, 909
- LONGHOLE - elongated hole
 - Function, 544
 - Parameter, 546
- Longitudinal slot - SLOT1
 - Function, 517
 - Input simple, 518
 - Parameter - input complete, 523
 - Parameter - input simple, 523

M

- Machine control panel
 - in the sidescreen, 82
 - Operator controls, 38
- Machine model, 701
- Machine-specific information, 836
- Machining step program, 279
- Machining times
 - Delete, 185
 - Display - G code program, 257
 - Display - ShopTurn program, 281
 - Display in block display, 49, 154
- Machining with fixed counter-spindle
 - Function, 647
- Machining with traversable counter-spindle
 - Function, 639
- Magazine
 - Deleting tools, 741
 - Loading tools, 741
 - Positioning, 740
 - Relocating tools, 742
 - Unloading tools, 741
- Magazine list, 738
- Magazine management, 709
- Main spindle, 122
- Maintenance tasks
 - Monitoring/performing, 927
- Manual Machine, 845
 - Circle, 853
 - Contour turning,
 - Drilling, 856
 - Manual mode, 850
 - Milling, 860
 - Set limit stop, 849
 - Simulating, 861
 - Single-cycle machining, 855
 - Straight line, 852
 - Traversing axes, 850
 - Turning, 857
 - Zero/work offset, 848
- Manual mode, 133
 - Circle, 853
 - Settings, 148
 - Straight line, 852
 - Traversing axes, 138
- Manual retraction, 141
- Master dimension
 - Fit calculator, 446
- MDA
 - Deleting a program, 131

MDI
 Executing a program, 130
 Loading a program, 128
 Saving a program, 129

Measurement
 Tool, 724

Measurement result log
 Settings, 110
 Tool, 106
 Workpiece zero, 108

Messages
 Displaying, 827
 Sorting, 828

Milling
 B axis, 867
 Manual Machine, 860

Milling contour pocket - CYCLE63
 Function, 581
 Input simple, 581
 Parameter - input complete, 584
 Parameter - input simple, 584

Milling contour spigots - CYCLE63
 Function, 589
 Input simple, 589
 Parameter - input complete, 591
 Parameter - input simple, 592

Mode groups, 94

Mold making view
 adapting, 219
 Changing a graphic, 222
 Changing the section, 223
 Editing a program block, 220
 Programs, 217
 Searching for program blocks, 221
 Starting, 219

MRD (Measuring Result Display), 169

Multi-channel data, 658

Multi-channel editor, 657
 Synchronized view, 677
 Time synchronous view, 681
 Wait points, 681

Multi-channel program
 Creating, 658
 Editing a G code program, 665
 Editing the ShopTurn program, 667

Multi-channel support
 Changing the job list, 664
 Defining multi-channel data, 658
 Multi-channel view, 657
 Program blocks, 674
 Running-in a program, 688
 Simulation, 686

Multi-channel view, 651
 "Machine" operating area, 651
 Block search, 689
 Multi-channel support, 657
 OP015, OP019, 653
 Program control, 689
 Settings, 655, 677

Multi-edge - CYCLE79
 Function, 512
 Input simple, 513
 Parameter - input complete, 515
 Parameter - input simple, 515

Multitool, 755
 Creating, 756
 Delete, 760
 Equipping tools, 758
 Loading, 760
 Parameters in the tool list, 755
 Positioning, 763
 Reactivating, 761
 Relocating, 762
 Removing tool, 759
 Unloading, 761

Multitouch panel
 SINUMERIK Operate Gen. 2, 69
 Widescreen format, 77

N

Navigation bar
 Sidescreen, 77

NC memory, 768

NC/PLC variables
 Changing, 832, 934
 displaying, 830, 932

Network
 displaying symbol identifiers, 952
 editing, 950

Network properties, 951

New contour
 Function - Milling, 558
 Function - Turning, 438
 Parameter - Turning, 440
 Parameters - Milling, 561

Number of teeth, 719

O

Online help
 Context-sensitive, 66

- Open slot - CYCLE899
 - Function, 534
 - Input simple, 535
 - Parameter - input complete, 542
 - Parameter - input simple, 542
 - Operands
 - Cross-references, 954
 - inserting, 950
 - Operating areas, 27
 - Changing, 50
 - Selecting, 50
 - Operating mode
 - AUTO, 94
 - Changing, 50
 - JOG, 93, 133
 - MDI, 94
 - REPOS, 93
 - TEACH IN, 94
 - Operation
 - deleting, 950
 - inserting, 950
 - Operator controls
 - Display Manager, 86
 - Machine control panel, 38
 - Operator panel fronts, 28
 - Keys, 30
- P**
- Pages, 77
 - Parameter
 - Backing up, 816
 - Calculating, 52
 - Changing, 52
 - Counterspindle, fixed, 648
 - Counter-spindle, traversable, 643, 644, 645
 - Entering, 51
 - Path milling - CYCLE72
 - Function, 568
 - Parameter, 574
 - Path motion, 627
 - Pitch circle position pattern - HOLES2
 - Parameter, 397
 - Pitch circle position pattern – HOLES2
 - Function, 391
 - PLC properties, 930
 - PLC signals
 - displaying, 937
 - editing, 937
 - PLC user program
 - Absolute address, 942
 - Diagnostics, 929, 944
 - Enlarging/reducing the ladder diagram, 942
 - Ladder editor, 929
 - loading, 930
 - Resetting processing times, 930
 - Search function, 955
 - Shortcuts, 940
 - Symbolic address, 942
 - User interface, 939
 - PLC user programs
 - Editing, 947
 - Plunge turning - CYCLE952
 - Function, 469
 - Input simple, 471
 - Parameter - input complete, 473
 - Parameter - input simple, 476
 - Plunge turning residual material - CYCLE952
 - Function, 476
 - Parameters, 477
 - POCKET3 - rectangular pocket
 - Function, 481
 - Input simple, 482
 - Parameter - input complete, 487
 - Parameter - input simple, 487
 - POCKET4 - circular pocket
 - Function, 491
 - Input simple, 491
 - Parameter - input complete, 496
 - Parameter - input simple, 497
 - Polar coordinates
 - Overview, 292
 - Position pattern
 - Block search, 167
 - Positioning
 - Magazine, 740
 - Multitool, 763
 - Positions
 - display, 397
 - Hiding, 397
 - Predrilling contour pocket - CYCLE64
 - Function - Centering, 576
 - Function - Predrilling, 576
 - Parameter - Centering, 579
 - Parameter - Predrilling, 580
 - Preview
 - Program, 786
 - Processing times
 - reset in the PLC user program, 930
 - Program
 - Closing, 772
 - Copying, 789
 - Correcting, 158
 - Creating with cycle support, 264

- Deleting, 791
- Editing, 174
- Executing, 774
- Highlight, 787
- Inserting, 789
- Managing, 765
- Naming convention, 776
- Open, 772
- opening additional programs, 181
- Preview, 786
- Properties, 792
- Renumbering blocks, 179
- Replacing text, 176
- Running-in, 152
- Searching for a program position, 174
- Selecting, 151, 787
- Teach-in, 881
- Program block
 - Access protection, 946
 - adding, 945
 - Changing, 307
 - Copying and inserting, 177
 - creating, 943, 945
 - Current, 48, 154
 - Delete, 177
 - deleting, 950
 - editing, 943, 945, 947, 948
 - Information, 938, 943
 - insert, 177
 - linked, 286
 - Multi-channel support, 674
 - Numbering, 178, 179
 - opening in the window, 946
 - Repeat, 304
 - Replacing, 299
 - Search, 174
 - Selecting, 177
 - Structure, 286
- Program control
 - activate, 170
 - Modes of operation, 169
 - Multi-channel view, 689
- Program correction, 158
- Program header, 296
- Program level, 156
- Program list, 782
- Program Manager, 765
 - Displaying HTML documents, 801
 - Displaying PDF documents, 801
 - Searching for directories and files, 784
- Program runtime, 225

- Program settings - ShopTurn program
 - Changing, 308
 - Parameters, 309
- Program status, 941
- Program views
 - G code program, 256
 - ShopTurn program, 280
- Programmed stop 1, 169
- Programmed stop 2, 169
- Programming variables
 - G code program, 274
 - ShopTurn program, 316
- Properties
 - Directory, 792
 - Program, 792
- Protection levels
 - Softkeys, 64
- PRT (no axis motion), 169

Q

- Quantity, 306

R

- R parameters, 201
 - Backing up, 816
- Reactivating
 - Multitool, 761
 - Tool, 735
- Reaming - CYCLE85
 - Function, 346
 - Parameter, 348
- Rectangular pocket - POCKET3
 - Function, 481
 - Input simple, 482
 - Parameter - input complete, 487
 - Parameter - input simple, 487
- Rectangular spigot - CYCLE76
 - Function, 500
 - Input simple, 500
 - Parameter - input complete, 504
 - Parameter - input simple, 504
- Reference, 90
- Relocating
 - Multitool, 762
 - Tool, 740
- Remote access
 - Allowing, 841
 - Setting, 840

- Remote diagnostics, 840
 - Exit, 843
 - requesting, 842
- Removing tool
 - Multitool, 759
- Repeat positions
 - Function, 398
 - Parameter, 399
- Replacement tool number, 718
- Repositioning, 159
- Retract, 141
- RG0 (reduced rapid traverse), 169
- Row position pattern - HOLES1
 - Parameter, 386
- Row position pattern – HOLES1
 - Function, 384

- S**
- Save
 - Parameter, 816
- SB (single blocks), 169
- SB1, 152
- SB2, 152
- SB3, 152
- Screen layout, 74
- Screenshots
 - Copy, 829
 - Creating, 829
 - Open, 829
- Search
 - in the Program Manager, 784
- Search function
 - PLC user program, 955
- Search mode, 165
- Search pointer, 163
- Searching
 - Logbook entry, 839
- Selecting
 - Directory, 787
 - Program, 787
- Service Planner, 927
- Setting actual values, (See setting zero offsets)
- Setting milling tool - CYCLE800
 - Function, 607
 - Parameter, 609
- Settings
 - Collision avoidance, 704
 - Editor, 182
 - For automatic operation, 227
 - For manual operation, 148
 - Measurement result log, 110
 - Multi-channel function, 677
 - Multi-channel view, 655
 - Teach-in, 892
 - Tool lists, 753
- Setup data
 - Backing up, 812
 - reading in, 814
- ShopTurn program
 - Approach/retraction cycle, 318
 - Circle with known center point, 631
 - Circle with known radius, 633
 - Clamping the spindle, 500
 - Creating, 294, 778
 - Cutting edge (D), 300
 - Cutting rate (V), 301
 - Entering the quantity of workpieces, 306
 - Feedrate (F), 301
 - Graphic view, 280
 - Machining cycle, approach/retraction, 288
 - Machining planes, 287
 - Machining step program, 279
 - Machining type, 302
 - Machining with traversable counter-spindle, 639
 - Polar coordinates, 635
 - Program blocks, 299
 - Program header, 296
 - Program settings, 308
 - Programming variables, 316
 - Radius compensation, 300
 - Spindle speed (S), 301
 - Straight and circle, 627
 - Straight line, 629
 - Straight line polar, 636
 - Structure, 286
 - Tool (T), 300
- Shortcuts
 - Operator panel fronts, 30
- Sidescreen
 - ABC keyboard, 82
 - MCP, 82
 - Navigation bar, 77
 - Operator controls, 77
 - Overview, 77
 - Pages, 82
 - Requirements, 77
 - Show, 79
 - Standard widgets, 79
 - Widgets, 77
- Simulation
 - Alarm display, 254
 - Changing the feedrate, 248
 - Changing the graphic section, 252

- Manual Machine, 861
 - Moving the graphic, 251
 - Multi-channel support, 686
 - Non-modal, 249
 - Program control, 248
 - Rotating the graphic, 251
 - Showing and hiding the path display, 246
 - Views for multi-channel support, 687
 - Simultaneous recording, 233
 - Blank input, 246
 - Changing the graphic section, 252
 - Moving the graphic, 251
 - Rotating the graphic, 251
 - Single block
 - Coarse (SB1), 152
 - Fine (SB3), 152
 - SINUMERIK Operate Gen. 2
 - Screen layout, 74
 - Skip blocks, 170
 - SKP (skip blocks), 169
 - SLOT1 - longitudinal slot
 - Function, 517
 - Input simple, 518
 - Parameter - input complete, 523
 - Parameter - input simple, 523
 - SLOT2 - circumferential slot
 - Function, 526
 - Input simple, 527
 - Parameter - input complete, 531
 - Parameter - input simple, 531
 - SMS messages, 913
 - Log, 920
 - Special characters, 29
 - Spindle chuck data
 - Parameter, 123
 - Store chuck dimensions, 121
 - Spindle data
 - Actual value window, 48
 - Spindle speed limitation, 121
 - Standard widget
 - Actual values, 79
 - Alarms, 80
 - Axle load, 80
 - Service life, 81
 - Tool, 81
 - Zero point, 80
 - Starting hole, 167
 - Startup, 89
 - Status display, 43
 - Stock removal
 - in JOG, 143
 - Parameters, 144, 145
 - Stock removal - CYCLE951
 - Function, 400
 - Parameter, 403
 - Stock removal - CYCLE952
 - Function, 449
 - Input simple, 453
 - Parameter - input complete, 456
 - Parameter - input simple, 459
 - Stock removal residual material - CYCLE952
 - Function, 459
 - Parameters, 461
 - Straight line, 627
 - Manual Machine, 852
 - Submode
 - REF POINT, 93
 - Subprogram
 - Parameters, 614
 - Switching over
 - Coordinate system, 96
 - Swiveling - CYCLE800
 - Function, 597
 - Parameter, 604
 - Symbol tables, 953
 - Symbolic identifiers
 - displaying in the network, 952
 - Synchronization commands
 - Display, 258, 282
 - Synchronized actions
 - Displaying status, 214
 - Synchronized view
 - Multi-channel editor, 677
 - Synchronizing a counter-spindle
 - Function, 695
 - Multi-channel support, 695
 - Parameters, 696
 - System data
 - Displaying HTML documents, 801
 - Displaying PDF documents, 801
- ## T
- Tailstock, 123
 - Tapping with compensating chuck - CYCLE840
 - Function, 367
 - Input simple, 368
 - Parameter - input complete, 373
 - Parameter - input simple, 373
 - Tapping without compensating chuck - CYCLE84
 - Function, 367
 - Input simple, 368
 - Parameter - input complete, 373
 - Parameter - input simple, 373

- Teach-in, 881
 - Changing blocks, 889
 - Circle intermediate position CIP, 886
 - Continuous-path mode, 884
 - Deleting blocks, 891
 - General sequence, 882
 - Inserting a position, 883
 - Inserting blocks, 885
 - Motion type, 884
 - Parameter, 883
 - Rapid traverse G0, 886
 - Selecting a block, 890
 - Settings, 892
 - Traversing block G1, 886
 - Templates
 - Creating, 783
 - Storage locations, 783
 - Thread
 - Re-machining, 146
 - Synchronizing, 146
 - Thread centered
 - Function, 618
 - Parameters, 621
 - Thread chain - CYCLE98
 - Function, 428
 - Input simple, 429
 - Parameter - input complete, 432
 - Parameter - input simple, 434
 - Thread milling - CYCLE70
 - Function, 546
 - Parameters, 548
 - Thread turning - CYCLE99
 - Function - Face thread, 411
 - Function - Longitudinal thread, 411
 - Function - Tapered thread, 411
 - Input simple, 411
 - Parameter - Input complete - face thread, 426
 - Parameter - Input complete - longitudinal thread, 416
 - Parameter - Input complete - tapered thread, 421
 - Parameter - Input simple- face thread, 428
 - Parameter - Input simple- longitudinal thread, 418
 - Parameter - Input simple- tapered thread, 423
 - Tip angle, 719
 - Tool
 - Change type, 752
 - Changing the cutting edge position, 752
 - Creating, 722
 - Delete, 725
 - Details, 743
 - Dimensioning, 713
 - Loading, 726
 - Measure manually, 100
 - Measurement, 724
 - Measurement result log, 106
 - Measuring, 100
 - measuring using a magnifying glass, 105
 - Reactivating, 735
 - Relocating, 740
 - Unloading, 726
 - Tool change
 - Coolant, 720
 - Tool data
 - Actual value window, 47
 - Backing up, 812
 - reading in, 814
 - Tool list, 718
 - Tool lists
 - Settings, 753
 - Tool management, 707
 - List filtering, 748
 - Sorting lists, 747
 - Tool parameters, 713
 - Tool types, 710
 - Touch operator controls
 - Cancel alarms, 75
 - Changing the channel, 75
 - Touch Panel
 - calibration, 901
 - Transformed view, 753
 - Turning
 - Manual Machine, 857
- ## U
- Undercut - CYCLE940
 - Function - DIN thread, 408
 - Function - Form E, 406
 - Function - Form F, 406
 - Function - Thread, 408
 - Parameter - DIN thread, 409
 - Parameter - Form E, 407
 - Parameter - Form F, 408
 - Parameter - Thread, 410
 - Unique cutting edge number, 720
 - Unit of measurement
 - switching, 96
 - USB drive, 769
 - User agreement, 91
 - User data, 199
 - User variables
 - Activating, 207
 - Backing up, 816
 - Channel GUD, 204

- Defining, 207
- Global GUD, 203, 207
- Global R parameters, 200
- Local LUD, 205
- Program PUD, 206
- R parameters, 201
- Searching, 206

V

- Variable screen forms, 834
- Virtual keyboard
 - "SINUMERIK Operate Generation 2" user interface, 76
 - HT 8, 899
- Virtual keys
 - ABC keyboard, 77
 - MCP keys, 77

W

- Wear list, 733
- Widgets, 77
- Work offsets
 - Calling, 303
 - Delete, 118
 - Overview, 113
- Work plan
 - ShopTurn program, 280
- Working area limitation, 120
- Workpiece
 - Creating, 777
 - Starting machining, 149
 - Stopping machining, 149, 150
- Workpiece counter, 225
- Workpiece zero
 - Measurement result log, 108

Z

- Zero offsets
 - Active ZO, 113
 - Displaying details, 116
 - Overview, 112
 - Settable ZO, 115
 - Setting, 98
- Zero point
 - DXF file, 190
- Zero point settings
 - Backing up, 812
 - reading in, 814