



FRYER

MACHINE SYSTEMS

Precision Built Solutions™

FRYER / SIEMENS 828 HS-CNC CONTROL

828 JOB SHOP & PRODUCTION MILL OPERATOR MANUAL



TABLE OF CONTENTS

- TABLE OF CONTENTS 1
- SAFETY INFORMATION 2 - 4
- MILL QUICK REFERENCE GUIDE 5
- 828 MILL BASIC CONTROL INFORMATION 6
- BASIC SCREEN / CONTROL INFORMATION 7
- KEY DESCRIPTIONS 8 - 12
- MAN - MANUAL OPERATING SCREEN 13
- USING THE REMOTE ELECTRONIC HANDWHEEL (Option) 14
- MOVING THE MACHINE THROUGH THE CONTROL 15
- T, F, S DISPLAY SCREEN 16
- MANUAL SCREEN INPUT OPERATIONS 17 - 18
- TOOL LIST SCREEN 19 - 20
- CREATE A TOOL IN THE LIBRARY 21 - 22
- MEASURE A TOOL MANUALLY 23
- MEASURE A TOOL AUTOMATICALLY W/ TOOL PRESETTER (Option) 24
- SET AXES ZERO (WORKPIECE) OFFSETS 25
- MEASURE WORKPIECE OFFSETS MANUALLY 26
- MEASURE WORKPIECE OFFSETS AUTOMATICALLY W/ TOOL PROBE (Option) 27
- DO ONE CYCLE OPERATIONS 28 - 32
- MDI - MANUAL DATA INPUT SCREEN 33
- PROG – PROGRAM MANAGER SCREEN 34 - 35
- CREATING A SHOPMILL PROGRAM 36 - 37
- CREATING A PROGRAM GUIDE G-CODE PROGRAM 38 – 39
- SIMULATION SCREEN 40
- EXECUTE A PROGRAM 41
- HANDWHEEL RUN (Option) 42
- AUTO – RUN PROGRAM SCREEN 43
- KEYSWITCH INFO 44
- CONVERTING A FANUC G CODE PROGRAM 45
- ADDITIONAL MILL CONTROL OPTION INFORMATION 46 – 47
- REFERENCES 48
- DISCLAIMER 49

READ BEFORE INSTALLING OR OPERATING

NOTE: THIS MACHINE IS AUTOMATICALLY CONTROLLED AND MAY START AT ANY TIME.



All CNC machines contain hazards from rotating parts, belts and pulleys, high voltage electricity, noise, and compressed air. When using CNC machines and their components, basic safety precautions, including all appropriate LOTO procedures must always be followed to reduce the risk of personal injury and mechanical damage.

It is the machine owner's responsibility to make sure all personnel who are involved in installation and operation of this machine is thoroughly acquainted with the procedures and safety instructions provided herein *BEFORE* they perform any actual work.

Only Fryer factory-trained service personnel should troubleshoot and repair the equipment.

Do not modify or alter this equipment in any way without first consulting Fryer Machine. Any modification or alteration of this equipment could lead to personal injury and/or mechanical damage and could void your warranty.



1. Keep machine and area around it clean and well lit. Never allow chips, coolant, or oil to remain on the floor. Do not leave loose objects on or around machine.
2. Use appropriate eye and ear protection while operating the machine. ANSI-approved impact safety goggles and OSHA-approved ear protection is recommended to reduce the risks of eye injury and hearing loss.

3. Keep all loose clothing, hair, and jewelry away from the machine at all times.
4. Gloves are easily caught in moving parts. Take them off before using the machine.
5. Always wear safety shoes with steel toes and oil-resistant soles.
6. Do not paint, alter, deface, or remove any warning plates from the machine. Replacement plates are available from Fryer Machine Systems.
7. Keep flammable liquids and materials away from the work area and hot chips.
8. Coolant and oils can make surfaces on the machine slippery. They can also present an electrical hazard if the machine has power on. Therefore, do not stand on any part of the machine at any time.
9. Keep vises, clamps, fixtures, or work pieces from extending beyond the back edge of the table.
10. Check for damaged parts and tools before operating the machine. Any part of a tool that is damaged should be properly repaired or replaced. Do not operate the machine if any component does not appear to be functioning correctly.
11. Improperly clamped parts machined at high speeds/feeds may be ejected and puncture the safety door. Machining oversized or marginally clamped parts is not safe.
12. To avoid tool changer damage, ensure that tools are properly aligned with the spindle drive lugs when loading tools.
13. Windows must be replaced immediately if damaged or severely scratched – contact the factory for replacement panels.
14. Do not attempt to operate the machine before all the installation instructions have been completed.
15. Be sure to review the maintenance section of this manual for instructions to keep your machine running properly.

1.01 Mechanical Safety

1. Always press Emergency Stop when the machine is not in use.
2. Never operate the machine with any cover or shield open or removed.
3. Never reach into the work area when the spindle is turning or if the machine is in automatic mode.
4. Put the machine in manual mode and be sure last programmed function has been completed before reaching inside of the work area.
5. The functions of the machine make it impossible to eliminate all pinch points. Be particularly aware of the following pinch points:
 - a. Spindle and tool rotation
 - b. Indexing of ATC and tools
 - c. Table, saddle, and head.
6. Do not operate machine without axis motor covers or axis way covers in place.
7. Report any loose, worn, or broken parts to your supervisor. The same action should be taken if any unusual noise or machine action occurs.
8. The electric components are protected from normal moisture resulting from humidity or use of water-based coolants. **DO NOT** however, use a water hose to clean the machine or the area around it.

9. Never touch a machine control device or electrical component when your hand is wet.
10. Never clean up chips while the machine is running or is in automatic mode.
11. Do not file workpieces being rotated under power.
12. At the end of the workday the machine should be placed in "EMERGENCY STOP MODE"
13. When restarting a machine after it has been shut down always assume it has been altered. Recheck all phases of the job as though you were running the first piece.
14. Never run the spindle until hands, feet, and body are well clear of the work area.

1.02 Electrical Safety

1. **WARNING:** Electrical enclosures contain high voltage. Disconnect equipment from power source before opening cabinets.

2. Before replacing a fuse, switch off the machine.

3. Immediately turn off power if:

- Power problems develop
- In the event of electrical storms.
- Ambient temperatures exceed 105 degrees Fahrenheit (40 degrees C)

4. The electrical power must meet the specifications in this manual. Attempting to run the machine from any other source can cause severe damage and will void the warranty.

5. The electrical panel should always be closed and locked except during service.

6. When the main circuit breaker is on, there is high voltage throughout the electrical panel and some components operate at high temperatures, therefore extreme caution is required.

7. Do not reset a circuit breaker until the reason for the fault is investigated.

8. Never service the machine with the power connected.

828 MILL QUICK REFERENCE

Tool Setup

Adding tool to the tool list

Press machine soft key' if not in manual / TFS screen

Press tool hard key

Press tool list soft key' if needed to show the tool list

1. Select any available tool location (not top spindle location)
2. Press "New Tool" soft key Select tool type and press "OK"
3. Type tool name, press input
4. Set approximate length if using tool probe, diameter, # cutting edges, coolant, rotation direction, etc. Repeat steps 1-4 above for each additional tool.

Getting tool to the TFS screen/spindle position

Press machine soft key if not in manual / TFS screen

Press "select tool" soft key (upper right side of screen)

Highlight-select desired tool

Press "OK" soft key' (lower right side of screen) - this will take you back to TFS screen

Press Cycle start (follow screen instructions if no tool changer)

Tool height offset (tool setter probe)

Press measure tool soft key (from main TFS screen)

Press length auto soft key - set offset info (yes or no, offset amount).

Press cycle start - machine will rapid to probe location and feed down to probe and set / establish length offset if course measurement is close

Tool height offset (manual)

Press measure tool soft key' (from main /TFS screen)

Press "Length manually" soft key (right side of screen)

Select "Workpiece" or "fixed point" and define value

Manually touch off tool, press "set length" soft key

Program Creation / Selection

Press program hard key or Program Manager soft key

Select existing program

Arrow/select desired program, press "open" soft key to open an existing program

Create new program

Press "new" soft key

From right side of the screen, select "Shop" Mill for conversational or "Program Guide G Code " for manually writing a g-code program

Type program name into box and press "OK" - this opens the program header - follow/fill out menu to define stock

Create program using "Drilling", "Milling" menus for many basic operations, or "Contour Milling" to draw geometry and create tool paths for the created geometry using "path mill" function in Contour Milling menu.

Work Offsets

Load probe, edge finder or tool into spindle / TFS screen

Press machine soft key' if not in manual / TFS screen

Press tool hard key Press work offset soft key

Arrow / highlight desired work offset (G54 for example)

Press "WO Select" soft key

Press details soft key to clear offset if desired

Press machine soft key' or manual hard key' to get back to TFS / manual screen

Press "measure workpiece" soft key

Select appropriate cycle from the right side of the screen to probe or edge find the work piece. The top option is for establishing a single axis, other cycles allow more options.

Follow menu for the selected cycle - probe cycles are semi-automatic and require set-up and depressing eyrie start. When using an edge finder, the cycles work similarly, but require manual positioning and "touch"

Program Execution / Program Run

After program has been completed, simulate to verify it is doing what is desired. If this checks out, press "Execute" soft key at lower right of screen to move program into memory. This will bring you to the "auto" screen area ("Auto" hard key will also bring you here)

Check spindle over-ride and federate over-ride knobs - suggest spindle at 100%, federate at 0 or 10% if testing- running a new program

If using handwheel run, press "handwheel run" key', followed by cycle start to begin executing the program (must select and axis and turn handwheel if using handwheel run)

If not using handwheel run, press cycle start to execute the program. Use the federate over-ride knob to manage program speed.

828 MILL BASIC CONTROL INFORMATION



- A - Screen
- B - Alpha Keypad
- C - Numeric Keypad
- D - Select & Cursor Keys
- E - Input / Enter Key
- F - USB, CF-card & Ethernet Access
- G - HELP Key
- H - Mode Select Keys
- I - Shortcut Hot Keys
- J - Auxiliary Keys
- K - Cycle Start /Feed Hold
- L - Jog Keys
- M - Coolant Control
- N - Spindle Control
- O - Manual Spindle Override
- P - Manual Feedrate Override
- Q - Emergency (E- Stop)
- R - Protection Key Switch

BASIC SCREEN / CONTROL INFORMATION

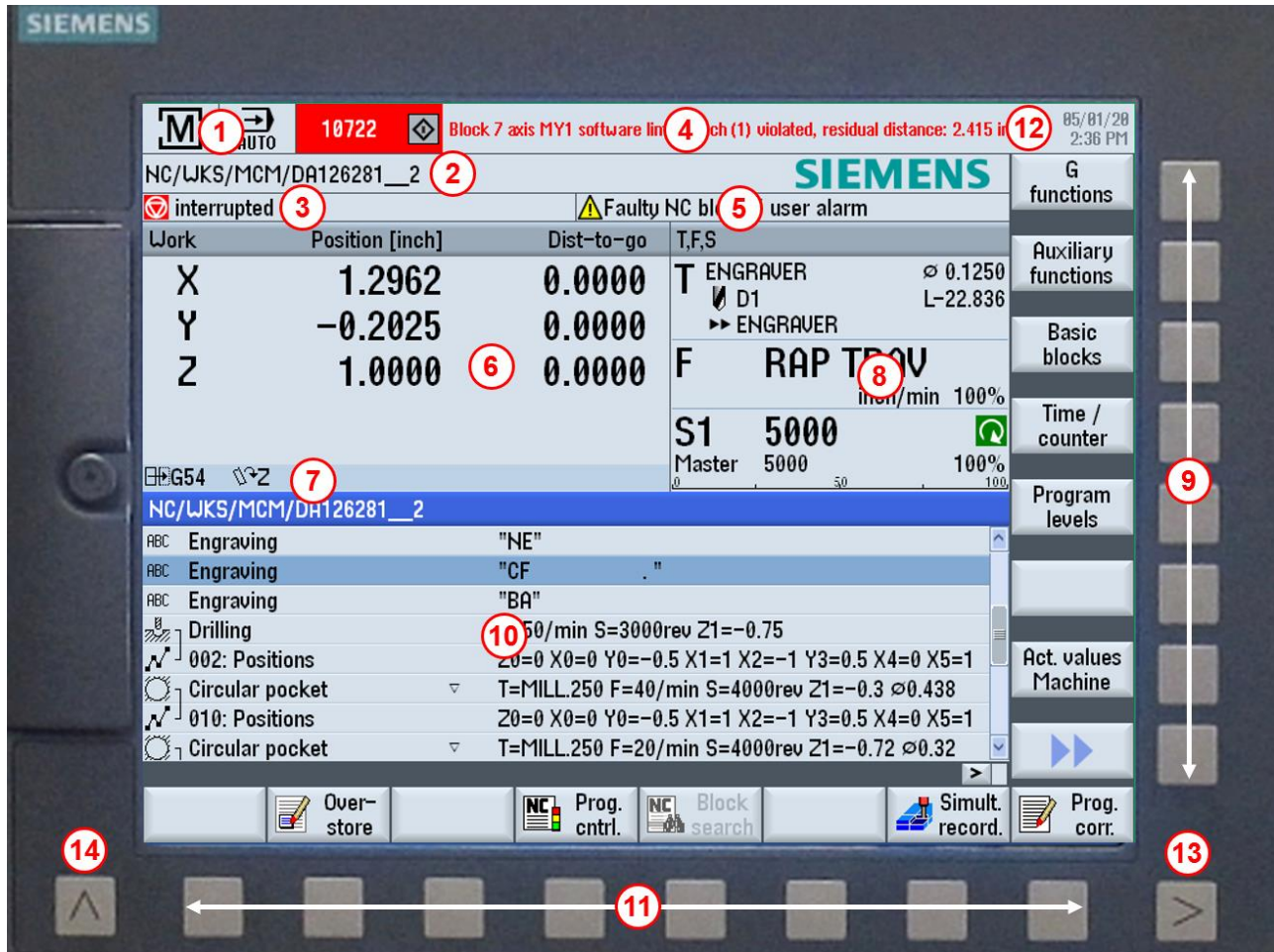

- | | |
|---|---|
| <ol style="list-style-type: none"> 1. Operation Sector 2. Program Path & Name 3. Program Status 4. Alarm & Message Line 5. Operation Messages 6. Axes Position 7. Active Work Offset & Rotation 8. Display of: <ul style="list-style-type: none"> T = Active Tool F = Present Feedrate S = Actual Spindle RPM Spindle Load % | <ol style="list-style-type: none"> 9. Vertical Softkeys 10. Working Window 11. Horizontal Softkeys 12. Date & Time 13. Extend Menu Key 14. Recall Key |
|---|---|



OPERATION MODE SELECT KEYS

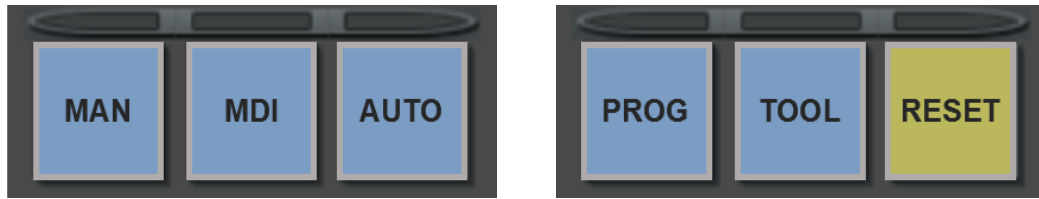

- **MAN** - Manual Operating Screen; functions available for manual operation of the machine.
- **MDI** - Manual Data Input Screen; enter G-code commands for manual machine operations.
- **AUTO** - Run Program Screen; programed machining operations are controlled from here
- **PROG** - Program Manager Screen; programs are written and stored here
- **TOOL** - Tool List Screen; data pertaining to tools and work offsets are accessed
- **RESET** - Resets the currently active program and some alarms. Note: Using the reset key will reset the program to its beginning.

MACHINE MODE HOT KEYS

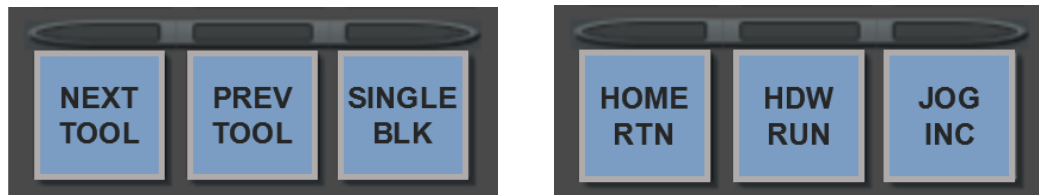

- **NEXT TOOL / PREVIOUS TOOL** - Selects the next or previous tool in the tool changer and will skip blank stations.
- **SINGLE BLOCK** - Program will run one block at a time. Cycles like tapping will complete the in and out motion before stopping.
- **HOME RTN** - Machine is equipped with absolute encoders and always remembers its last position before shutting down. When pressing this key, a message of press **CYCLE START** to continue comes up. All 3 axes move to their home position and stop. Machine position will now display Zero for all 3 axes.
- **HDW RUN** (option) - Allows the machine to follow the program by turning the remote or triple electronic handwheels. When you reverse the motion of the handwheel it will back up to the beginning of the last program block.
- **JOG INCR** - Changes the resolution of motion when pressing the axis jog keys. Toggling the key will show in the upper left corner of the screen the amount of movement per keystroke. 1=.0001", 10=.001" 100=.010"

AUXILLARY KEYS



- **TEACH** (option) - Allows you to store and save positions in G code format when moving the axes. This can be saved as program or run in MDI mode
- **REPOS** - Allows you to go back to the point you stopped your program without having to run all the previous movements again.
- **LIGHT** - Turns work light on and off. Light will come back on automatically when servos are turned on and reset is selected.



- **CYCLE START** – Starts the execution of the CNC in Auto Mode or operation in Manual Mode.
- **FEED HOLD** – Pauses feedrate during running of a program. Resumes after selecting CYCLE START key.

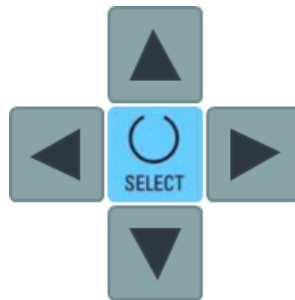

- **CURSOR** Keys - Navigates through the various fields or lines on the screen.
- **SELECT** - Makes changes to many different operations on the control. It allows you to change axis moves from absolute to incremental, spindle direction, how the tool enters the part etc.

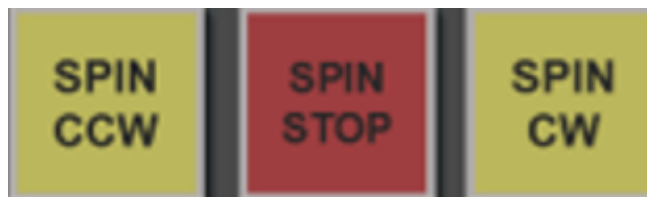

- **SPIN CCW / STOP / SPIN CW** – Control the direction after the spindle has been activated. SPIN STOP will stop the spindle, pressing either direction button will start it again.

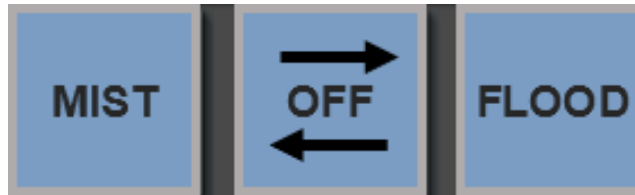

- **COOLANT** Keys – Manually turn coolant on or off. Mist is an available option.



- **HELP** - When you open a cycle and are not sure what it is asking for, select the Help key. The left side of the screen will display an explanation of every line in that cycle. You can also access the entire programming manual from this key.

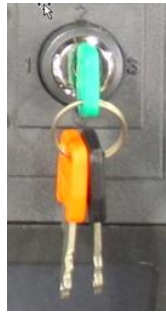

- **PROTECTION KEY SWITCH** - Reading and writing of user data are protected using the key switch. Provides a multilevel safety concept for controlling access to programs, data, and functions at various protection levels.

ADDITIONAL KEYS ON THE OPERATOR PANEL



- **MACHINE** - Opens the operating area Manual Operating screen. Corresponds to the **MAN** Operation Mode Select Key.
- **PROGRAM** - Opens the last program that was edited.
- **OFFSET** - Opens the Parameter screen for Tool list, Tool wear, Magazine, Work offset, User variable, and Setting data. Corresponds to the **TOOL** Operation Mode Select Key.

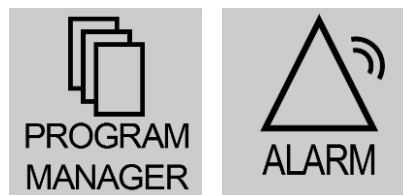

- **PROGRAM MANAGER** - Opens the operating area Program Directory screen. Corresponds to the **PROG** Operation Mode Select Key.
- **ALARM** - Opens the Alarm List screen. Return to the Manual Screen by pushing the **MAN** Operation Mode Select Key.



- **BACKSPACE** – When editing in a field block it deletes a character selected to the left of the cursor, when navigating in a program it deletes all the selected characters to the left of the cursor.
- **DEL** - When editing in a field block it deletes a character selected to the right of the cursor, when navigating in a program it deletes all characters.
- **INSERT** - Opens an editing window in the insert mode. Pressing the key again, exits the window and the entries are undone. When used in conversational programming it opens a selection box and shows the available options.

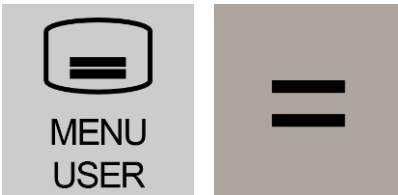

- **MENU SELECT** – Opens a screen with yellow horizontal keys to access various operating areas. Access to Diagnostics and Machine / Control data is found here.
- **EQUALS** - Opens a calculator that allows user to calculate values for entry fields. Choose between a simple standard calculator and the extended view with mathematical functions.

The following keys can be used in combinations are available for operation of the control and the machine tool.

Detailed information can be found in the **SIEMENS 828 MILLING OPERATING MANUAL**

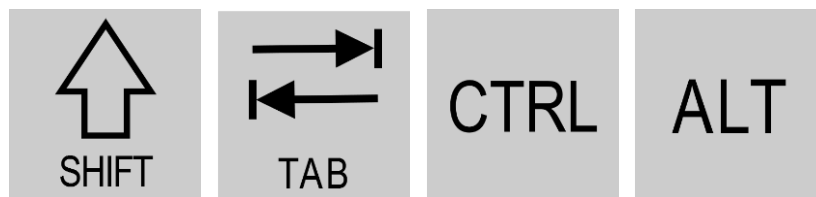

- **SHIFT** - If the Shift-key is held depressed, the upper character on keys with double usage will be entered.
- **TAB** - In the program editor, indents the cursor by one character. In the program manager, moves the cursor to the next entry to the right.
- **CTRL** – Used in combination with other keys navigate through programs.
- **ALT** - Used in combination with other keys navigate through programs.



- **NEXT WINDOW** - Toggles between the windows. Selects the first entry in selection lists and in selection fields and moves the cursor to the beginning of a text.
- **PAGE UP** - Scrolls up by one page in a window.
- **PAGE DOWN** - Scrolls down by one page in a window.

MAN - MANUAL OPERATING SCREEN

The screenshot displays the Siemens manual operating screen (MAN) interface. At the top left, there is a blue box with the text 'MAN'. The main screen area is divided into several sections:

- Top Bar:** Includes a Siemens logo, the date and time '04/01/20 11:53 AM', and the text 'NC/UJS/INFO/CIRCDIASQUARE2'.
- Reset Button:** A button labeled 'Reset' is located below the top bar.
- Work Position Table:** A table showing the current position of the workpiece in inches:

Work	Position [inch]	T.F.S
X	7.0000	T 5/8 EM \varnothing 0.6250 D1 L 0.0000 5/8 EM
Y	5.0000	
Z	7.0000	
- Feed Rate (F) and Spindle Speed (S) Section:**
 - F: 0.0000 inch/min 0.0%
 - S1: 0 rpm
 - Master: 0 50%
- Tool and Machining Parameters Section:**
 - T: 5/8 EM D 1
 - F: 200.0000 inch/min
 - S: 1500 rpm
 - α 1: 30.000°
 - Other M1 function: 19
 - Machining plane: G17 (XY)
- Navigation and Control Buttons:**
 - Left side: Directional arrows for +Z, -Z, +Y, -Y, +X, -X.
 - Right side: 'Select tool', 'Angle milling', 'Stops', and a blue arrow button.
 - Bottom: A row of function buttons: Meas. tool, Meas. workp., Straight Circle, Drilling, Milling, Cont. mill., Set Axes Zero, and Simulation.

The following functions are available by selecting the designated field and typing in the information or toggling the **SELECT** key for options, select the **INPUT** key and select **CYCLE START** key to execute:

- Perform a tool change (T) with direct access from the tool table,
- Designate feedrates (F) - IPM
- Define the spindle speed (S) RPM and direction, **CW**, **CCW** or **STOP**
- Specify the gear stage (**Gearbox equipped machines only**)
- Enter M function (M) if needed
- Select **G17/ G18** or **G19** machining planes

Other functions available:

- **ANGLE MILLING** – Move X & Y simultaneously at any angle
- **MEASURE TOOL** – Measure tool lengths / diameters
- **MEASURE WORKPIECE** – Set workpiece coordinates
- **SET AXES ZERO** – Activate zero offsets

DO ONE CYCLES

- **STRAIGHT / CIRCLE** - Straight Machining or Circular Machining
- **DRILLING** - Centering, Drilling, Reaming, Deep-Hole Drilling, Threads, Positions
- **MILLING** - Face Milling, Pocket, Spigot, Multiple Edge, Groove, Thread Milling, Engraving
- **CONTOUR MILLING** - Contour, Path Milling, Predrilling, Pocket

USING THE REMOTE ELECTRONIC HANDWHEEL (Option)



In the **MANUAL** screen, enter a feed rate in the **F** field and select the **INPUT** key

1. Select which axis is needing to move
2. Select the movement knob for each click on the **HANDWHEEL**
 - X1=.0001", X10=.0010", X100=.0100"
3. **CW** rotation moves the axis in the (+) direction; **CCW** rotation moves the axis in a (-) direction
4. Remote **CYCLE START** key (for automatic operations)
5. Remote **FEED HOLD** key (for automatic operations)
 - The **ANGLE MILLING** movements can be controlled with the remote handwheel.
 - The axis selection must be turned to **OFF** to disengage from the control.

MOVING THE MACHINE THROUGH THE CONTROL



1. In the **MANUAL** screen
2. Enter a feed rate in the **F** field
3. Select the **INPUT** key
4. Select any of the **AXIS** keys (+/- determines movement direction).
5. Feed rate can be overridden with the **FEED OVERRIDE** knob, actual feedrate will be displayed in the **T, F, S** Screen
6. Selecting the **JOG INC**, will allow movements incrementally each time the **AXIS** key is Selected; (1=.0001", 10=.0010", 100=.010")
7. Selecting the **JOG** key will cancel the incremental movement.

For the following, see page 18 for more detail.

8. Selecting the **ANGLE MILLING** key allows movement to cut tapers or radius machining.
9. Select the **STOPS** key – Electronically allows you to set a stop position for any axis, preventing axis movement beyond the stop position.

T, F, S DISPLAY SCREEN

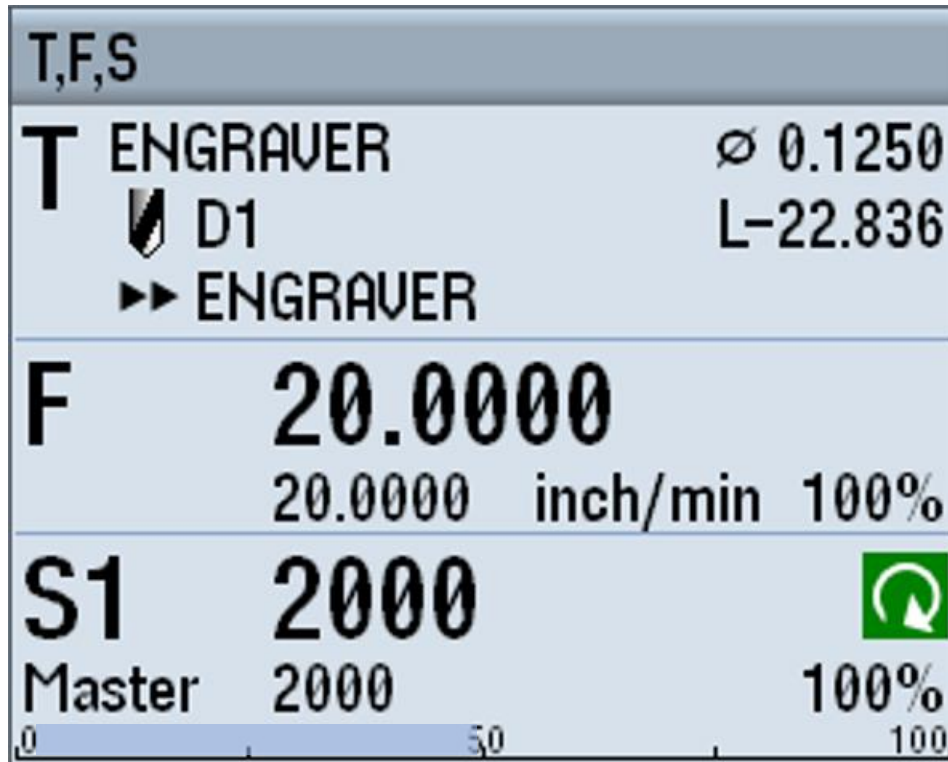

When the machine is running, this information is displayed.

- **T:** (Tool) Name of the active tool, edge number, radius of the tip and the tool offset data to the right.
- **F:** (Feed) Display of the active feed rate for the current operation in bold during machining, the programmed feed rate is under and the feed override in % is to the right.
- **S:** (Spindle) Display of the active spindle speed for the current operation in bold during machining, the programmed spindle speed is under and the speed override in % is to the right. Also displays current gear selection.
- Spindle load factor in % is displayed by a blue bar across the bottom.

MAN

MANUAL SCREEN INPUT OPERATIONS (T, F, S, Other M Function, Machining Plane)

T	MILL .375	D 1
F	24.0000	inch/min
S	1500	rpm
	↻	
Other M function		8

“T” Field

Select
tool

✓
OK

CYCLE
START

- To enter a tool in the T (tool name) field select the **SELECT TOOL** key on the right-hand side of the screen
- In the tool library move the arrow until you find the tool you want then select the **OK** key on the bottom right hand side of the screen
- Now select the **CYCLE START** to activate the tool loading program either for manual insertion or automatic
- To unload the tool from the spindle, type in **0** in the **T** field and press **CYCLE START**

“F” Field

➔
INPUT

- To change the feed rate (**IPM**), enter the value in the **F** (Feed) field, select **INPUT**. This will change the feed rate in any manual jogging of an axis

“S” Field

○
SELECT

CYCLE
START

- To start the spindle, enter an **RPM** in the **S** (spindle) field
- In the next field below change the spindle direction by selecting the **SELECT** to toggle between **CW** or **CCW**; then select the **CYCLE START**
- In next field to the right, make a software gear change by selecting the **SELECT** to toggle between **I** or **II**; then select the **CYCLE START**. (**Gear box equipped machines only**)

“Other M function” Field

CYCLE
START

- Enter an M-Code number in the **OTHER M FUNCTION** field; you do not need to put an “M” in front of it, just the number, and select the **CYCLE START**.

“Machining Plane” Field



- Select the **SELECT** on the control to scroll through the machining planes; (**G17/G18/G19**) and Select the **CYCLE START** to activate

ANGLE MILLING key

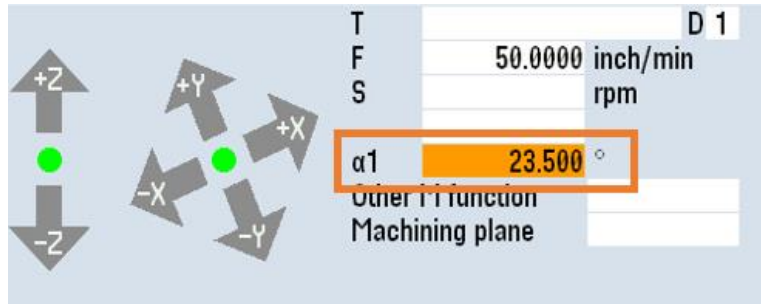

- Select this key, the screen will change to allow an angle to be entered in the Angle Degree Field and select **INPUT** key.
- By moving the X or Y axis with the Remote Handwheel or Axis keys, the movement will allow both Axes to move simultaneously at the selected angle.
- Select the **ANGLE MILLING** key again to turn off

SET ZERO AXIS Key

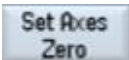

- Move any axis to a location while in the **MANUAL** screen and set the individual Zero offset quickly.
- Details are on page shown on the **SET AXES ZERO** section page.

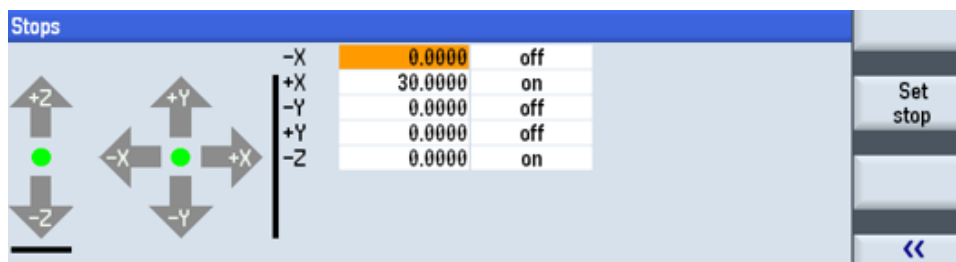

STOPS Key



- Move X, Y or Z axis to any location while in the **MANUAL** screen
- Select **STOPS** key, the screen shows which axis (+/-) limit(s) can be set.
- Highlight the required axis and either enter the desired limits or automatically set by selecting the **SET STOP** key on the right side of the screen.
- Toggle the **OFF / ON** with **SELECT** key to activate or deactivate the stop. Black bars will appear next to the activated axis.
- Select the **BACK** key to return to the **MANUAL** screen.

TOOL LIST SCREEN

05/06/20
8:09 AM

Tool list load magazine

Loc.	Type	Tool name	D	H	Length	∅	Tip angle	1	2
		DRILL 1/4	1	0	-24.4510	0.2500	118.0	<input checked="" type="checkbox"/>	<input type="checkbox"/>
1		MILL.250	1	0	-25.9410	0.2500		<input type="checkbox"/>	<input type="checkbox"/>
2		FACING TOOL	1	0	-25.9975	2.0000		<input type="checkbox"/>	<input type="checkbox"/>
3		MILL 1/2 X 1	1	0	-26.0257	0.5000		<input type="checkbox"/>	<input type="checkbox"/>
4		MCMCHAMFER	1	0	-26.1502	0.0100		<input type="checkbox"/>	<input type="checkbox"/>
5								<input type="checkbox"/>	<input type="checkbox"/>
6		MILL 3/4 ROUGHER	1	0	-25.4029	0.7500		<input type="checkbox"/>	<input type="checkbox"/>
7		TAP 8-32	1	0	-24.9726	0.1320	32.0000	<input type="checkbox"/>	<input type="checkbox"/>

Magazine selection

Tool list Tool wear Magazine Work offset R User variable SD Setting data

Tool operating data can be managed in the tool list. Column headers:

- **LOC** – Position in tool changer, if equipped.
- **TYPE** – Turning tool, drill, etc.
- **TOOL NAME** – Unique description of tool.
- **D** – Cutting edge number (max. of 9).
- **H** – Designation tool length when using ISO programming.
- **LENGTH** – Geometry data length for Z.
- **DIAMETER** – Cutter diameter.
- **ANGLE / PITCH** – Drill tip or tap pitch.
- **N** – Number of teeth (flutes).
- **SPINDLE DIRECTION** – CW, CCW or STOP
- **COOLANT 1 / 2** – Automatically activates when checked.

Functions available:

- **TOOL MEASURE** – Measure tool lengths & diameters, manually or automatic utilizing probes.
- **NEW TOOL** – Opens screen to identify a new and associated data.
- **EDGES** – Add additional cutting edges descriptions for tools.
- **LOAD / UNLOAD** – Allows changing tool positions in a tool changer, if available.

- **DELETE** – Clears all data on selected tool.
- **MAGAZINE SELECTION** – Displays all tools not assigned to a tool changer position.
- **TOOL WEAR** - Enter length & diameter wear. Monitor the tools' working times by workpiece count, tool life or wear.

Loc.	Type	Tool name	ST	D	ΔLength	Δφ	T	C	D
		.375 CBD ENDMILL 1	1	1	0.0000	-0.0020			
		.375 CBD ENDMILL 1	1	2	0.0000	0.0000			
1		11 TPI THREADMILL	1	1	0.0000	0.0000			
2		.875 HSS DRILL	1	1	0.0000	0.0000			
3		1.00 ENDMILL	1	1	0.0000	0.0000			
4		.750 BALL ENDMILL	1	1	0.0000	0.0000			
5		3D_PROBE	1	1	0.0000	0.0000			
6		.200 EDGE FINDER	1	1	0.0000	0.0000			

- **WORK OFFSET** - This view lists all offsets in Machine Coordinate System (**MCS**) & Workpiece Coordinate System (**WCS**), rotations, scaling and mirroring.
- Under each work offset is a Fine adjustment that lets you make small corrections to a position without changing the initial offset.

		X	Y	Z	A	SP
G54		-18.0670	-5.5670	5.0000	0.0000	0.0000
	Fine	-0.0100	0.0000	-0.0200	0.0000	0.0000
G55		-20.0670	-10.6540	3.0000	0.0000	0.0000
	Fine	0.0000	0.0000	0.0000	0.0000	0.0000
G56		0.3750	0.0000	0.0000	0.0000	0.0000
	Fine	0.0000	0.0000	0.0000	0.0000	0.0000
G57		0.0000	0.0000	0.0000	0.0000	0.0000
	Fine	0.0000	0.0000	0.0000	0.0000	0.0000
G505		0.0000	0.0000	0.0000	0.0000	0.0000
	Fine	0.0000	0.0000	0.0000	0.0000	0.0000
G506		0.0000	0.0000	0.0000	0.0000	0.0000
	Fine	0.0000	0.0000	0.0000	0.0000	0.0000
G507		0.0000	0.0000	0.0000	0.0000	0.0000

- **R VARIABLES** - Channel-specific variables that you can use within a G-code program or **SHOPMILL** programs.

R 0	0	R 20	0	R 40	0.75
R 1	0	R 21	0	R 41	1.06066017177982
R 2	0	R 22	0	R 42	0
R 3	0	R 23	0	R 43	0
R 4	0	R 24	0	R 44	0
R 5	0	R 25	0	R 45	0
R 6	0	R 26	0	R 46	0

TOOL

CREATE A TOOL IN THE LIBRARY

Loc.	Type	Tool name	ST	D	Length	Ø			
1									
2		MILL 3/4 ROUGHER	1	1	-25.4029	0.7500		3	2
3		FACING TOOL	1	1	-25.9975	3.0000		5	2
4									
6		DRILL 1/4	1	1	-24.4510	0.0000	118.0	2	<input checked="" type="checkbox"/>



- The **TOOL LIST** is opened.
- Select the position where the new tool should be stored using the arrow keys.
- Select an empty magazine location or a position below the magazine numbers.
- Press the **NEW TOOL** key.



- The **NEW TOOL - FAVORITES** window opens.
- or
- To create a tool that is not in the "**Favorites**" list, press the key "**Cutters 100-199**", "**Drill 200-299**", or "**Spec.tool 700-900**", and their respective window will open.



- Select the tool by moving the arrow keys to the selected tool and select the **OK** key, this window will close.

Type	Identifier	Tool position
120	- End mill	
140	- Facing tool	
200	- Twist drill	
220	- Center drill	
240	- Tap	
710	- 3D probe	
711	- Edge finder	
110	- Ball nose end mill	
111	- Conical ball end	
121	- End mill corner rounding	
155	- Bevelled cutter	
156	- Bevelled cutter corner	
157	- Tap. die-sink. cutter	

ENTER TOOL DATA

Tool list											magazine		Tool measure	
Loc.	Type	Tool name	D	H	Length	∅		N	⌀	⌀	1	2		
1														
2		.500 EM 4F	1	0	0.0000	0.5000		4	<input checked="" type="checkbox"/>	<input type="checkbox"/>				
3		CALIBRATION TOOL	1	0	-25.2739	0.0000			<input type="checkbox"/>	<input type="checkbox"/>			Edges	
4		TAP 1/4-20	1	0	-24.5968	0.2500	20.000		<input type="checkbox"/>	<input type="checkbox"/>				
5		DRILL 1/4 LONG	1	0	-20.1113	0.0000	118.0		<input type="checkbox"/>	<input type="checkbox"/>				
6		FACING TOOL	1	0	-21.5000	3.0000		5	<input type="checkbox"/>	<input type="checkbox"/>			Further data	
7		DRILL 1/2	1	0	-21.4870	0.0000	118.0		<input type="checkbox"/>	<input type="checkbox"/>				

- Name the tool with a unique description, i.e., “.500 EM 4F”
- Leave Length space at 0.000 until measurement cycle is performed.
- Enter Diameter of the tool.
- Enter number of flutes in the **N** column (tip angle for drills, pitch for taps)
- Select the direction of rotation with **SELECT** key
- Check the coolant field to automatically turn on in the program, with the **SELECT** key
- If the tool has other data that needs to be entered, i.e., angle, radius, etc., select the **FURTHER DATA** key shows, select to open that window.
- After all data is entered, select either the **TOOL MEASURE** key to continue with measuring the tool or select the **MAN** key to return to the **MANUAL** screen.



TOOL

MEASURE A TOOL MANUALLY

Fixed Point or Workpiece

Measure: length manually

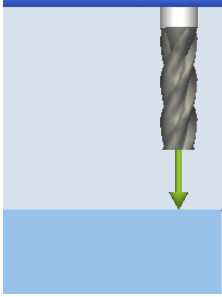

T	.500 EM 2F	D 1	Tool data
Ref. point	Workpiece	L	7.0000
Z0	0.0000	Ø	0.5000

Diameter manually

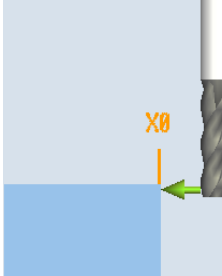

T	.500 EM 2F	D 1	Tool data
X0		L	7.0000
Y0		Ø	0.5000

- Load a new tool in the Tool Name screen and Select **CYCLE START** to load the tool in the spindle
- Select the **MEASURE TOOL** key, the measurement options will appear on the right side
- Select the **LENGTH MANUALLY** or **DIAMETER MANUALLY** key, then decide If you will need to use the Workpiece or a Fixed Point to determine reference point
- Using either a remote handwheel or moving the Z axis with the -Z axis key control, move the tool down to touch off on the **WORKPIECE** or the **FIXED OBJECT**.
- Select the **SET LENGTH** or **SET DIAMETER** key on the right-hand side, the measurements will be placed in the tool library
- Select the **BACK** key twice on the right-hand side to get back to the **MANUAL** screen



TOOL

MEASURE A TOOL AUTOMATICALLY WITH TOOL PRESETTER (Option)

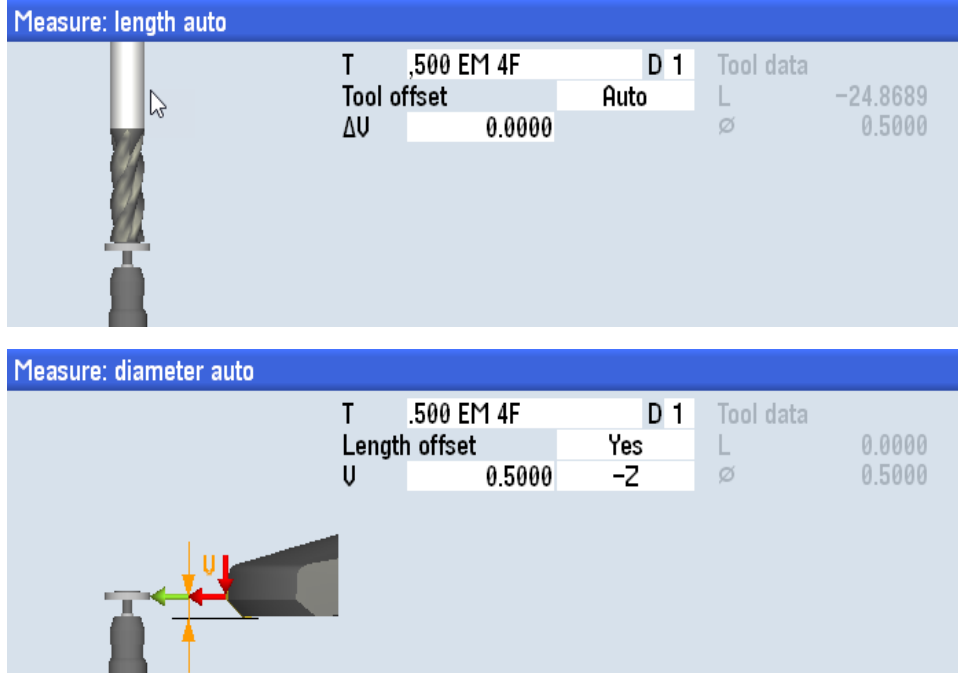

Z+

- Select the plus Z + axis key to take the machine to home **Z0**

IMPORTANT: Measure from the tabletop to the bottom of the tool with a tape measure, write down the approximate measurement (+/- .250")

Select tool

- Select the **SELECT TOOL** key
- Make sure that the tool you are measuring is selected and enter the measurement as a **NEGATIVE NUMBER** under the length column
- Select the **CANCEL** key, it will change back to the MANUAL screen

Cancel

Meas. tool

- Select the **MEASURE TOOL** key, the measurement options will appear on the right side of the screen.

Length auto

- Select the **LENGTH AUTO** key and turn down the feed rate and then select **CYCLE START** key. Tool diameters larger than .500" will offset and start rotating opposite of the direction field before touching the probe.

Diameter auto

- **(For non-Fryer Tool Probe Only)** Select the **DIAMETER AUTO** key and turn down the feed rate and then select **CYCLE START** key.



- The **FEED RATE** knob will control how fast the tool moves towards the tool probe
- When the tool touches the tool probe it will back up a short amount, the measurements will be placed in the tool library.



- Select the **BACK** key twice on the right-hand side to get out of the **MEASURE TOOL** cycle.



SET AXES ZERO (WORKPIECE) OFFSETS

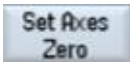

- In the **MANUAL** screen, push **SELECT TOOL** key and highlight a Tool or Edge Finder in the tool library.
- Select the **OK** key
- Select **CYCLE START** to load the tool or edge finder in the spindle.
- Move the tool or edge finder until it touches the workpiece.
- Select **SET AXES ZERO** key to open this window.

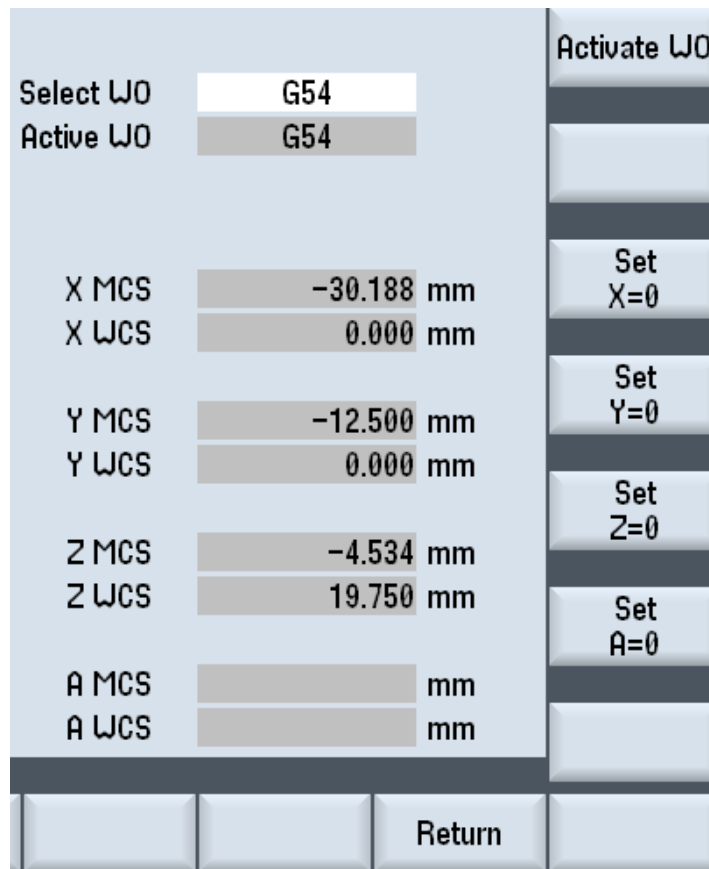

- Use the **SELECT** key to toggle to the Work Offset (G54...G57 only) you need.
- Select the **ACTIVATE WO** key.
- Select the **SET (X, Y, Z) = 0** key, (**SET A = 0**, if applicable). It will show the Machine Coordinate System (**MCS**) position and 0.000 in the Work Coordinate System (**WCS**) position.



- Select the **RETURN** key to get back to the **MANUAL** screen.



MEASURE WORKPIECE OFFSETS MANUALLY



- In the **MANUAL** screen, push **SELECT TOOL** key and highlight a tool or edge finder in the tool library.

- Select the **OK** key

- Select **CYCLE START** to load the tool or edge finder in the spindle.

- Select **MEASURE WORKPIECE** key the measurement options will appear on the right-hand side; select which measuring operation you want to use.

- The available Workpiece measurement cycle options are for Edges, Corners, Pockets, Holes and Spigots.

- Press the Key to the right of workpiece measurement option required and select the **INPUT** key.

- The measuring input box will open.

- Toggle the **SELECT** key to choose either Measuring only the Work Offset you are working with.

- Use the remote handwheel to locate the tool or edge finder at the position(s) shown on the screen.

- Move the tool or edge finder until it touches the workpiece then select the **P#** keys save the position

- When all positions have been saved select the **SET WO** key to load the work offset positions

- Select the **BACK** key on the right-hand side to get back to the **MANUAL** screen

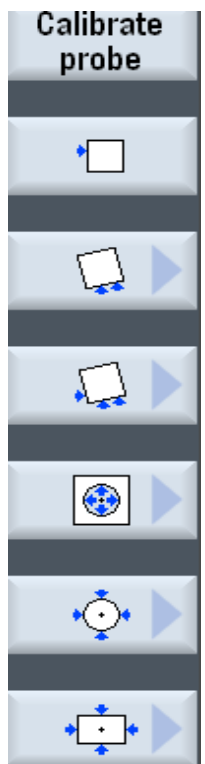

TOOL

MEASURE WORKPIECE OFFSETS AUTOMATICALLY WITH PART PROBE (Option)

Select
tool

OK

CYCLE
START

- In the **MANUAL** screen, push **SELECT TOOL** key and highlight the PROBE in the tool library.
- Select the **OK** key and select **CYCLE START** key.
- Load the probe in the spindle.

IMPORTANT NOTES for the FRYER Probe:

- The Fryer Probe only measures in the X & Y axes.
- There **MUST BE CONTINUITY** between the probe and the workpiece. Recommend using a short piece of electrical wire to check that there is continuity. Rust, paint, grease, or any material preventing continuity will not allow the probe to automatically measure and can result in major damage to the probe.
- Select **MEASURE WORKPIECE** key the measurement options will appear on the right-hand side; select which measuring operation you will be wanting to use.

The available workpiece measurement cycle options are for Edges, Corners, Pockets, Holes and Spigots.

Meas.
workp.

INPUT

SELECT

CYCLE
START

- Press the key to the right of workpiece measurement option required and select the **INPUT** key.
- The measuring input box will open.
- Toggle the **SELECT** key to choose either **MEASURING ONLY** or the **WORK OFFSET** you are working with.
- Use the handwheels or axis jog keys to locate the probe at the position(s) shown on the screen. When the probe is in position away from the workpiece, select the **CYCLE START** on the Control or Remote Handwheel and the probe will automatically touch off at that point and back away.
- **IMPORTANT NOTE:** Some operations will automatically move to another position to measure, make sure the clearances are adequate to prevent damage to the probe.
- When all the required edges are measured select the **SET WO** key to load the work offset positions.
- Select the **BACK** key on the right-hand side to get back to the **MANUAL** screen.

Calibrate
probe



Set
WO

BACK

DO ONE CYCLE OPERATIONS

More detailed structuring of the machining operations can be found in the Programming Section the **SIEMENS 828 MILLING OPERATING MANUAL**

In the **MANUAL OPERATING SCREEN**, you can execute Do One operation



without writing a program.

- This is done by selecting one of the keys located across the bottom of the screen.
- Fill in the various parameters for tool, feed, speed, and dimensions and hit OK to run the cycle in manual mode.
- **STRAIGHT / CIRCLE** key lets you do simple line and arc moves by filling in end points and feed rates.
- **DRILLING** key provides Centering, Drilling, Reaming, Deep Hole Drilling, Boring and Thread cycles. and use the position boxes to do one hole, a line of holes, grid, frame, or bolt circles.
- **MILLING** key gives you cycles for Pocketing (round or rectangle), Spigot (islands and bosses), Slots, Thread Milling and Engraving.
- **CONTOUR MILL** key lets you create simple or complex tool paths and then connect them to a machining cycle like Path Milling, Rough Drill or Pocketing.
- **SIMULATION** key can be selected to view the program before it is executed to check for any machining issues. The workpiece **BLANK** dimensions may have to be changed to show a more accurate simulation. See the section on **SIMULATION** for details.
- If coolant is needed during the machining operation, you can start it by pushing the **FLOOD COOLANT** key on the control or check the coolant field in the tool library to run when the tool runs.



STRAIGHT / CIRCLE Key

- This gives you options of where you want to move your Axis, either Individually or multiple axes and at your required feed rate or rapid movement.
- You have options of making linear movements, arcing movements, or circular movements.

The screenshot shows the Siemens CNC control interface. At the top, there is a 'Reset' button and the 'SIEMENS' logo. Below this, a table displays the current work position in inches (X: 0.0000, Y: 0.0000, Z: 25.9410) and tool information (T: MILL.250, D1, L-25.9410). The feed rate (F) is set to 0.0000 inch/min. The 'Straight all axes' menu is open, showing a 2D coordinate system with a blue arrow indicating movement. The menu options include 'Straight X α', 'Straight Y α', 'Circle', 'Rapid traverse', and 'Back'. The bottom toolbar contains icons for 'Meas. tool', 'Meas. workp.', 'Straight Circle', 'Drilling', 'Milling', 'Cont. mill.', 'Set Axes Zero', and 'Simulation'.

- Select **GRAPHIC VIEW** to open a small window showing what is programmed.

For the **STRAIGHT / CIRCLE** cycle only

- You must have the tool in the spindle, RPM configured in the **T, F, S** and tested by pushing the **CYCLE START** key. Push the **SPIN(dle) STOP** key to stop the spindle until needed.
- If coolant is needed during the machining operation, you can start if by pushing the **FLOOD COOLANT** key on the control or check the coolant field in the tool library to run when the tool runs.
- There is no starting **X0, Y0** or **Z0** fields to fill in data. That operation executes from the axes wherever they are positioned at the time the **CYCLE START** key is selected.
- When all the information is entered, select the **CYCLE START** to display in the **AUTO** screen to start the operation.
- Activate the spindle before pushing the **CYCLE START** key. The **FEED OVERRIDE** knob can be used to adjust the programed feed rate.

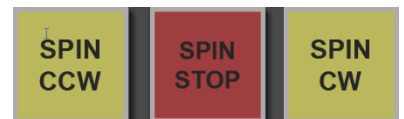



DRILLING Key

- This gives you options for Centering, Drilling, Reaming, Deep Hole Drilling, Boring and Thread cycles.
- Selecting the **POSITION** key opens optional drill patterns required, such as Pattern, Line, Grid, Frame, Circle or Arc.

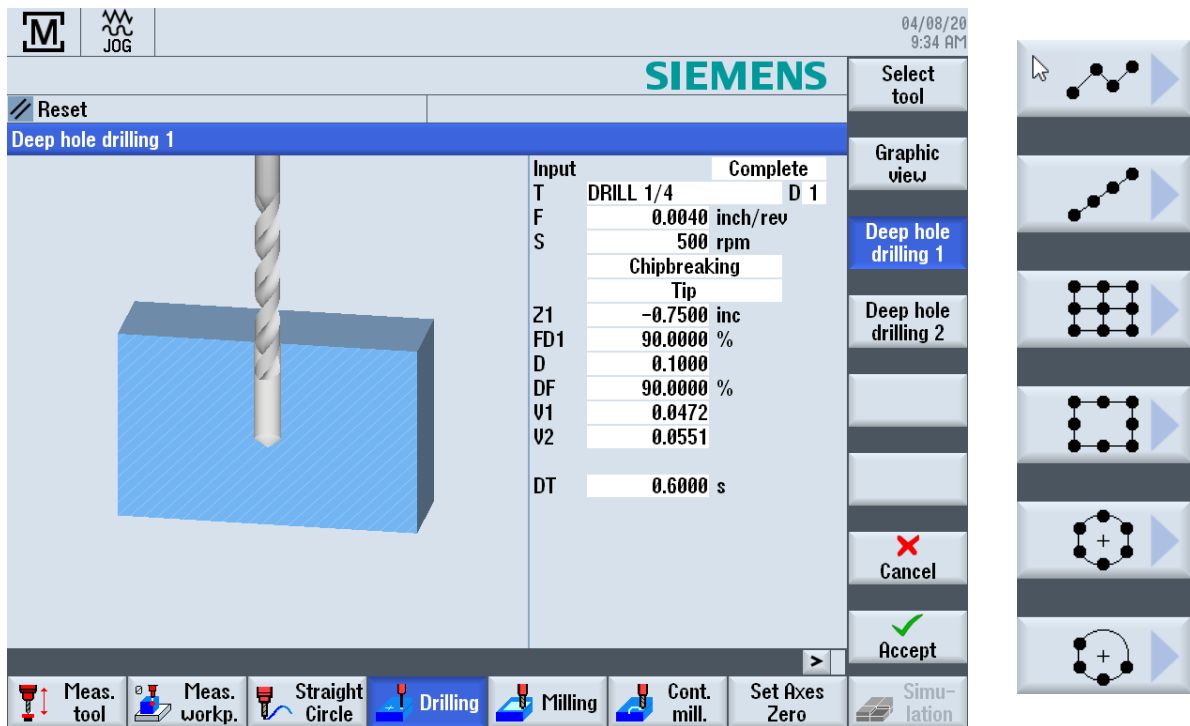

- Select **GRAPHIC VIEW** to open a window showing what is programmed.

Prior to starting, set your work offsets.

- Move the tool to the position where the machining operation will start in X, Y & Z and select the **SET AXES ZERO** key to set your zero work offsets. Then back away from that position and move the Z axis above the zero position.
- When all the information is entered, select the **ACCEPT** key to display in the **AUTO** screen.
- Select the **POSITIONS** key and select the type of drilling pattern required.
- When the position data is entered select the **ACCEPT** key and the information will be placed below the drill cycle in the **AUTO** screen to start the operation.
- Activate the spindle before pushing the **CYCLE START** key. The **FEED OVERRIDE** knob can be used to adjust the programmed feed rate.



MILLING Key

- **MILLING** gives you cycles for Pocketing (Rectangular or Circular), Spigot (islands and bosses), Slots, Thread Milling and Engraving.
- Select **GRAPHIC VIEW** to open a window showing what is programmed.

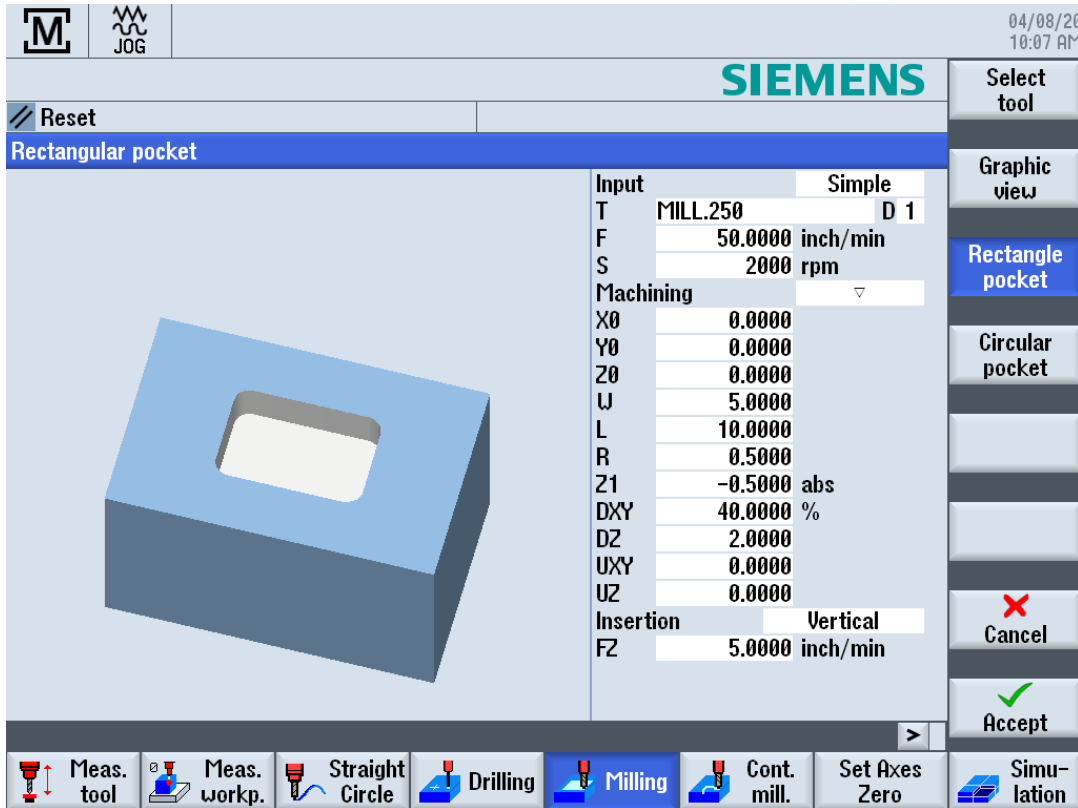

Prior to starting, set your work offsets.

- Move the tool to the position where the machining operation will start in X, Y & Z and select the **SET AXES ZERO** key to set your zero work offsets. Then back away from that position and move the Z axis above the zero position.
- Select the type of operation required from the keys on the right side of the screen.
- When all the information is entered, select the **ACCEPT** key to display in the **AUTO** screen to start the operation.
- Activate the spindle before pushing the **CYCLE START** key. The **FEED OVERRIDE** knob can be used to adjust the programmed feed rate.



CONTOUR MILL Key

- This gives the option of laying out coordinates for a contour shape then offers options of Path Milling, Rough Drill, or Pocket operations.

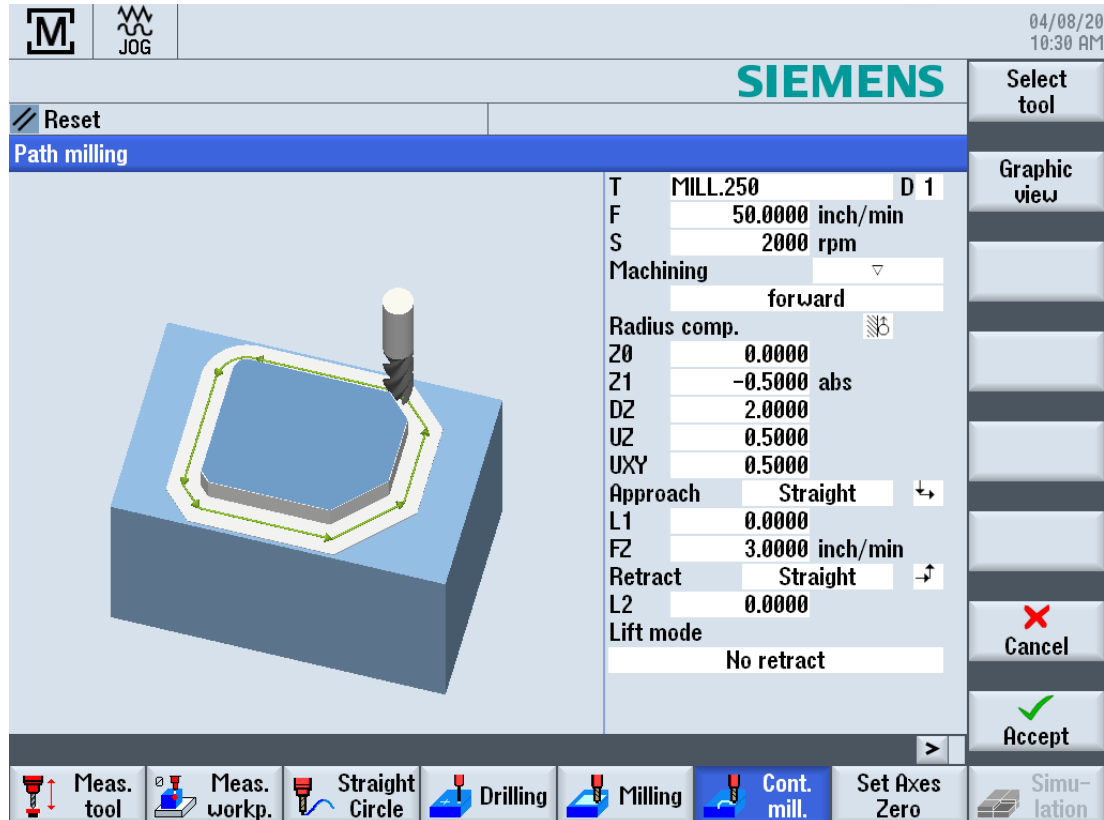

- Select **GRAPHIC VIEW** to open a window showing what is programmed.

Prior to starting, set your work offsets.

- Move the tool to the position where the machining operation will start in X, Y & Z and select the **SET AXES ZERO** key to set your zero work offsets. Then back away from that position and move the Z axis above the zero position.
- Select **NEW CONTOUR** key and the Starting Point window opens to set the first point in the contour. If doing a repeated contour, the **LAST CONTOUR** key can be selected if there is no interruption in operations.
- When the contour is completed select the **ACCEPT** key to display in the **AUTO** screen where optional machining keys are displayed on the right, i.e., **PATH MILLING**.
- Select the machining option key needed and fill in the required data and select the **ACCEPT** key. The contour and machining operation is ready to start.
- Activate the spindle before pushing the **CYCLE START** key. The **FEED OVERRIDE** knob can be used to adjust the programed feed rate.



MDI - MANUAL DATA INPUT SCREEN

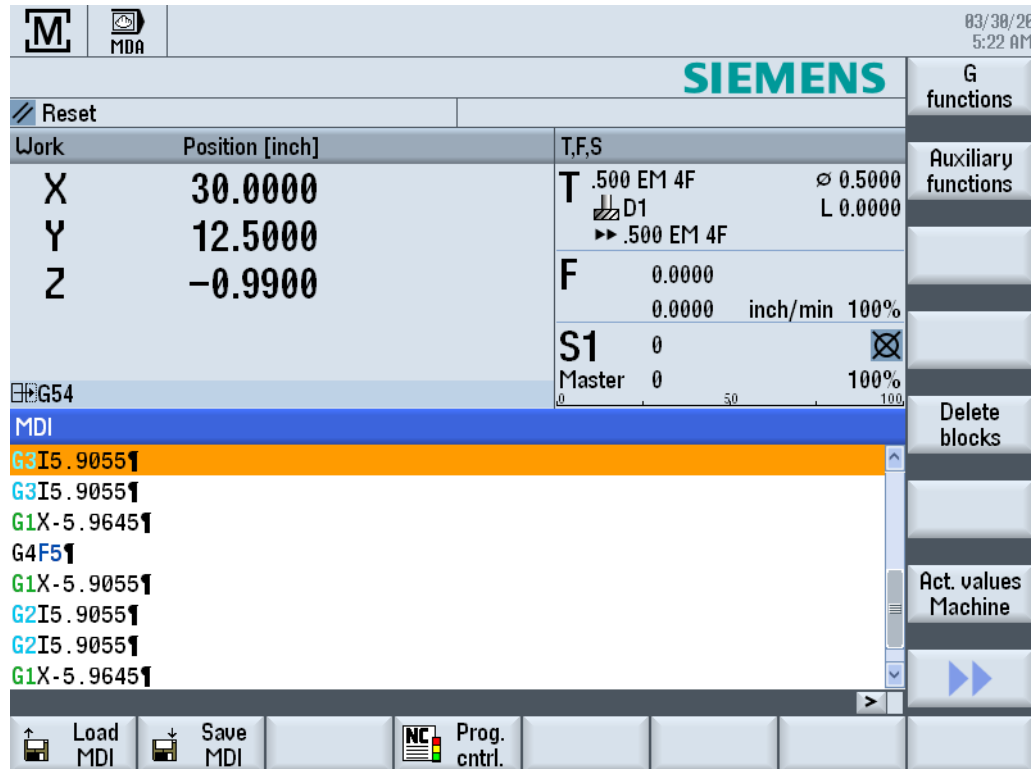

- Enter G-code commands or standard cycles block-by-block and immediately execute them for setting up the machine.
- Program is executed with **CYCLE START** key.
- **LOAD MDI** – Saved MDI or standard programs with standard cycles can be loaded from the program manager.
- **SAVE MDI** - Programs generated or modified in the MDI working window can be saved in the program manager, and later loaded, or edited.
- **DELETE BLOCKS** - If not wanting to save, easily deleted.
- **PROGRAM CONTROL** – Allows different ways of testing & running the program.

PROG – PROGRAM MANAGER SCREEN

More detailed structuring of the machining operations can be found in the Programming Section the **SIEMENS 828 MILLING OPERATING MANUAL**



- **SHOPMILL** or **PROGRAM GUIDE G-CODE** programs can be created in the **WORKPIECES** directory or in the **PART PROGRAMS** directory.
- **WORKPIECES** – Uses subdirectories (WPD) to contain program subfiles (.MPF) to store programs.

Functions on this screen-

- **NC** – Shows the directories and programs.
- **USB** – Data can be loaded and unloaded to the control. Direct program execution from a USB Flash Drive is not recommended.
- **EXECUTE** – Activates selected **.MPF** program to the **AUTO** screen.
- **NEW** – To start a new program; will need to designate either a **SHOPMILL** or **PROGRAM GUIDE G-CODE** program and enter a name.
- **OPEN** – Toggle the arrow keys to a **.MPF** extension program to open for editing.
- **MARK** – Select this key and scroll down to select any other lines below.
- **COPY** - Copies any highlighted lines.
- **PASTE** – When another item is highlighted after selecting the **COPY** key, the information will be pasted.
- **CUT** – In a program, this will delete a line in a program.

Select the next page key for additional functions.

The screenshot shows the Siemens SINUMERIK OPERATE interface. At the top, it displays 'SIEMENS' and 'SINUMERIK OPERATE' with a date and time of '04/05/20 12:22 PM'. Below this is a file manager window with a table of files and folders. The table has columns for Name, Type, Length, Date, and Time. The files are organized into folders: Part programs, HELIX, Subprograms, and Workpieces. The Workpieces folder is expanded, showing subfolders ANOTHER_FOLDER and FOLDER_NAME_HERE, and files MA_JOG_STEP1 and PART_PROGRAM_NAME. To the right of the table is a sidebar with buttons for Archive, Preview window, Search, Properties, and Delete. At the bottom of the interface, there is a status bar showing 'NC' and 'Free: 2.5 MB'. Below the status bar is a navigation bar with icons for NC and USB.

Name	Type	Length	Date	Time
Part programs	DIR		01/29/20	7:00:29 AM
HELIX	MPF	2459	11/27/13	3:11:05 PM
Subprograms	DIR		01/25/16	3:39:11 PM
Workpieces	DIR		04/05/20	12:06:45 PM
ANOTHER_FOLDER	WPD		04/05/20	12:05:57 PM
MA_JOG_STEP1	MPF	60	01/16/20	2:47:36 PM
FOLDER_NAME_HERE	WPD		04/05/20	12:07:00 PM
PART_PROGRAM_NAME	MPF	2053	01/31/20	4:21:34 PM

- **ARCHIVE** – You have the option of archiving individual files from the NC memory and the local drive.
- **PREVIEW WINDOW** – Opens any **.MPF** program to view. Shows in G-Code.
- **SEARCH** – Find information in the Program Manager for certain directories and files.
- **PROPERTIES** - Access rights for execution, writing, and reading.

CREATING A SHOPMILL PROGRAM

More detailed structuring of the machining operations can be found in the Programming Section the **SIEMENS 828 MILLING OPERATING MANUAL**

- Select either **PART PROGRAMS** or **WORKPIECES** directories to designate where the program will reside.
- **NOTE:** Names can contain up to 28 characters. Use any letters, digits. Use an underscore symbol “_” instead of the space key, no other symbols are accepted.
- Highlight if using the **PART PROGRAM** directory select the **NEW** key.
- Select the **PROGRAM GUIDE G-CODE** key and enter the unique program name in the screen then select the **OK** key.

programGUIDE
G code

New G code program

Type

Name

- The program header screen will open.
- or-
- Highlight if using the **WORK PIECES**, a subdirectory (**WPD**) will need to be entered in the blank field and then select the **OK** key.
- When an existing **WPD** is highlighted and the **NEW** key is selected, a new program will be created in that directory.

New workpiece

Type

Name

- Select the **SHOPMILL** key and enter the unique program name in the screen then select the **OK** key.

ShopMill

New sequential program

Type

Name

- The program header screen will open.

FILLING OUT THE PROGRAM HEADER

More detailed structuring of the machining operations can be found in the Programming Section the **SIEMENS 828 MILLING OPERATING MANUAL**

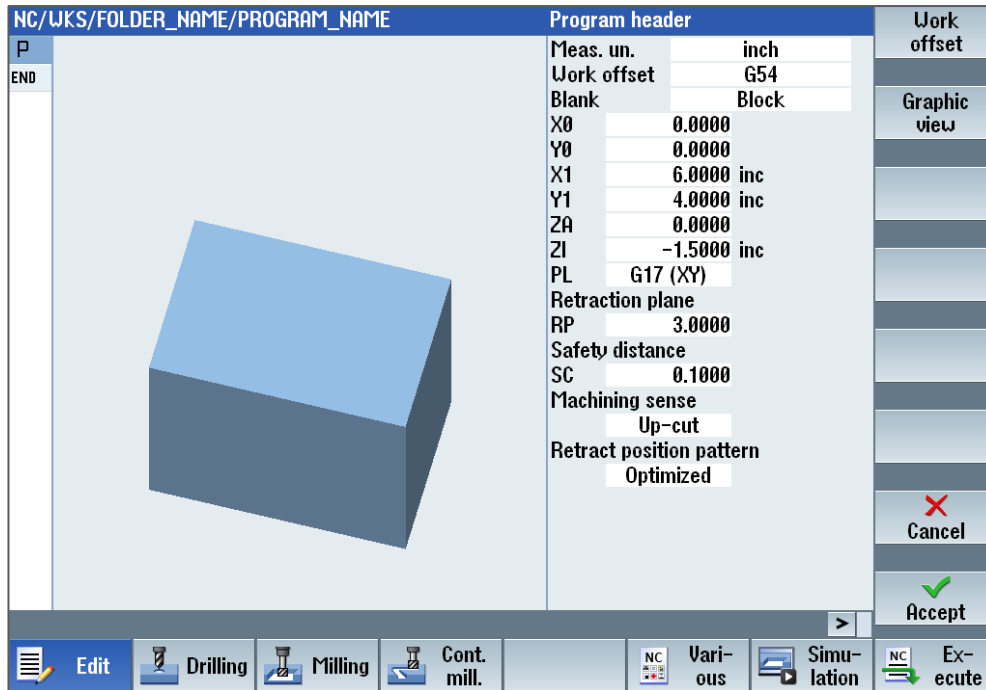

- Select a work offset and enter the type and dimensions of the blank and the parameters, tool axis, retraction plane, safety clearance and machining direction.
- Press the **ACCEPT** key.
- Program header and end of program are created as program blocks.
- Conversational programming can now be entered.

CREATING A PROGRAM GUIDE G-CODE PROGRAM

More detailed structuring of the machining operations can be found in the Programming Section the **SIEMENS G CODE PROGRAMMING MANUAL - MILLING**

- Select either **PART PROGRAMS** or **WORKPIECES** directories to designate where the program will reside.
- **NOTE:** Names can contain up to 28 characters. Use any letters, digits. Use an underscore symbol “_” instead of the space key, no other symbols are accepted.
- Highlight if using the **PART PROGRAM** directory select the **NEW** key.
- Select the **PROGRAM GUIDE G-CODE** key and enter the unique program name in the screen then select the **OK** key.

programGUIDE
G code

New G code program

Type

Name **PROGRAM_NAME**

- The blank program editor screen will open.
- or-
- Highlight if using the **WORK PIECES**, a subdirectory (**WPD**) will need to be entered in the blank field and then select the **OK** key.
- When an existing **WPD** folder is highlighted and the **NEW** key is selected, a new program will be created in that directory.

New workpiece

Type

Name FOLDER_NAME

programGUIDE
G code

- Select the **PROGRAM GUIDE G-CODE** key and enter the unique program name in the screen then select the **OK** key.

New G code program

Type

Name TEST

- The blank program editor screen will open.
- A G-code program can now be entered, various cycles can be opened and used.

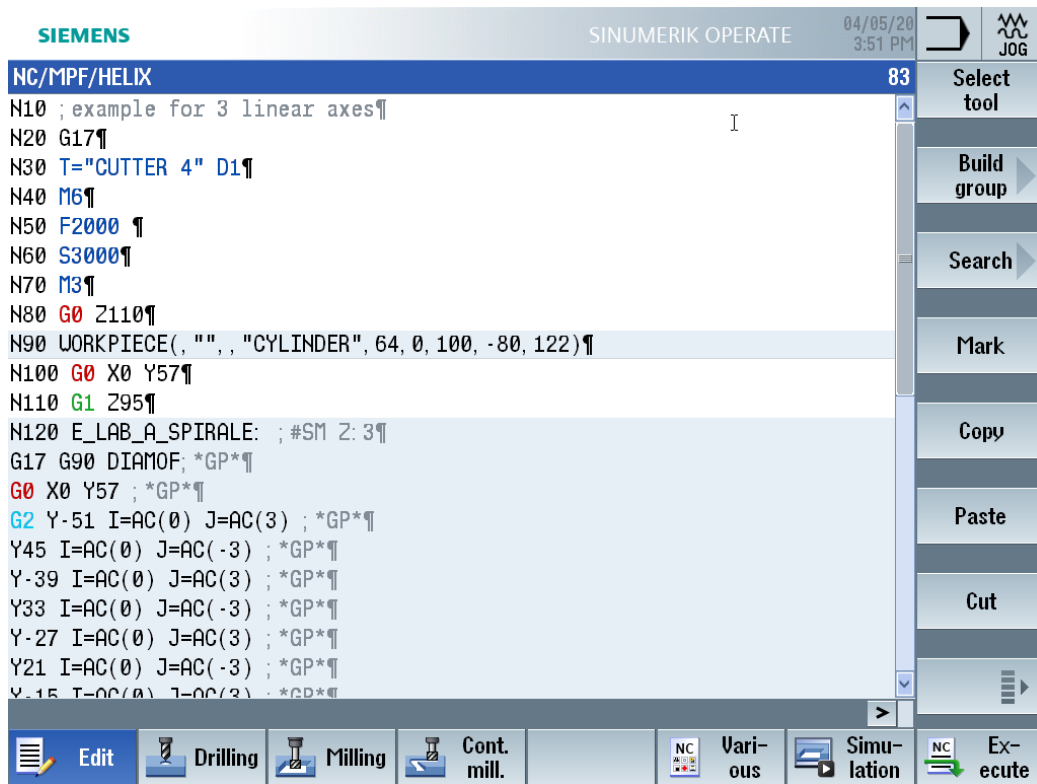

SIMULATION SCREEN

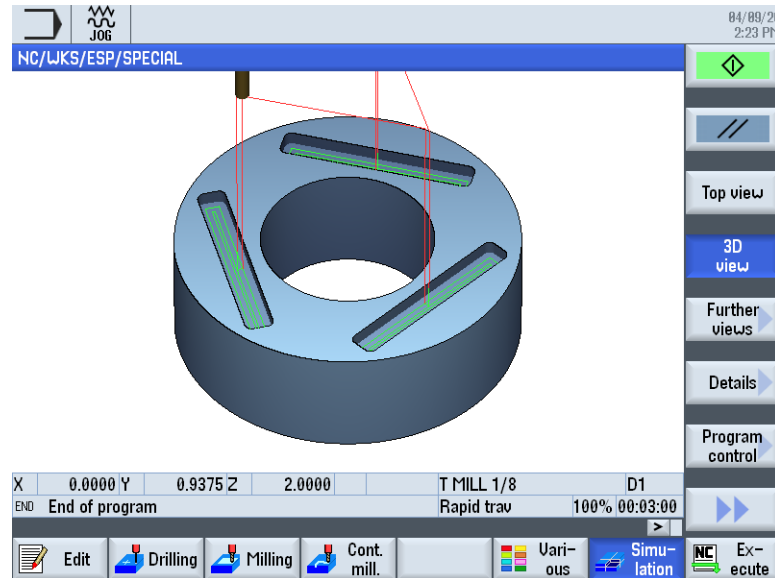

- During simulation, the current program is calculated in its entirety and the result displayed in graphic form. The result of programming is verified without moving the machine axes.
- Incorrectly programmed machining steps are detected at an early stage and incorrect machining on the workpiece prevented.
- The simulation represented on the screen uses the correct workpiece and tool measurements.
- For simulation, the workpiece is fixed in space. Only the tools move.
- The tool paths are displayed in color. Rapid traverse is red and the feedrate is green.

When using a **SHOPMILL** program, the blank dimensions that are entered in the program header to define the stock material and the coordinates for machining.

When using **PROGRAM GUIDE**, the (**WORKPIECE**) blank data is entered in the next block of code after the work offset is defined. It is accessed by selecting the **VARIOUS** key and selecting the **BLANK** key.

For example.

- **G54 G17**
- **WORKPIECE(",", "RECTANGLE", 64,0,-0.1,-80,3,3)**

If you select another work offset, then the coordinate system is converted, but the display of the blank is not changed.

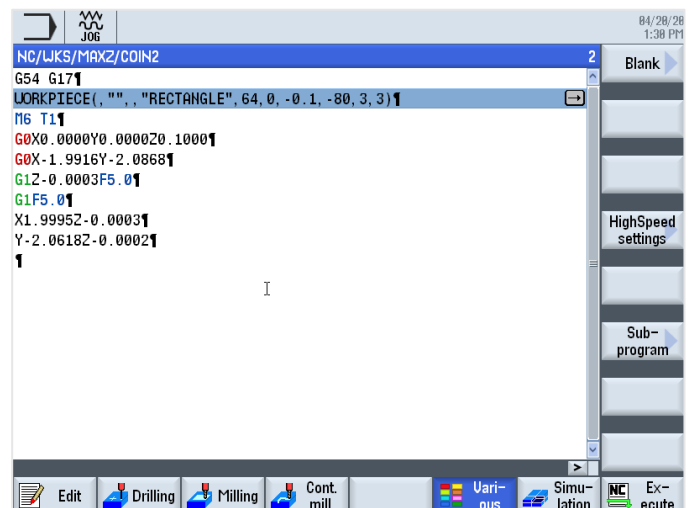

EXECUTE A PROGRAM

- After program has been completed and verified with the simulation, select the **EDIT** key at lower left of the screen and select the **EXECUTE** key on the bottom right.



- This will open the **AUTO** – Run Program screen.
- Select the **RESET** key to ensure the program starts from the beginning.



- The **FEED OVERRIDE** knob should be set to 0% and the **SPINDLE OVERRIDE** knob should be set to 100%.



- Select the **CYCLE START** to start the program.



- Adjusting the **FEED OVERRIDE** knob will control the programmed feedrate approaching the workpiece and during the machining process.



- The **FEED HOLD** key can be used to stop the feedrate at any time.



HANDWHEEL RUN (Option)

This feature allows you to control your program execution with the optional **REMOTE ELECTRONIC HANDWHEEL** or handwheels on the optional **3-HANDWHEEL CONSOLE**.

- Turning the handwheel causes the program to run with you in charge of the axis feed.
- Designed to make proving-out programs easier with safety and confidence.

To activate:

- The **HANDWHEEL RUN** option can be activated anytime and anywhere while running a program.
- Select the **HDW RUN** key on the control. A message will be displayed on the top of the screen indicating it has been activated.
- Turn the axis selection knob on the **ELECTRONIC REMOTE HANDWHEEL** to the X axis.

HDW
RUN

- Select the **CYCLE START** key.
- Turning the handwheel will move the axes through the program.
- When you stop turning, the axes will pause.
- Turn the handle the opposite direction and the axes move backwards through the program.

CYCLE
START

To deactivate:

- Stop turning the handwheel
- Select the **HDW RUN** key.
- Select the **CYCLE START** key to continue running the axes automatically.

HDW
RUN

CYCLE
START

AUTO

AUTO – RUN PROGRAM SCREEN

More detailed structuring of the machining operations can be found in the Programming Section the **SIEMENS 828 MILLING OPERATING MANUAL**

The screenshot shows the Siemens 828 MILLING OPERATING MANUAL interface. At the top, there is a status bar with 'M' and 'AUTO' icons, and the date/time '03/30/21 5:28 AM'. Below this, the program name 'NC/LKS/NEPTUNE/1619' is displayed. The main area is divided into several sections:

- Work Position [inch]:** X: 30.0000, Y: 12.5000, Z: -0.9900
- T,F,S:** T: .500 EM 4F, ∅ 0.5000, L 0.0000; F: 0.0000, 0.0000 inch/min 100%; S1: 0, 100%
- Program Levels:** A list of program blocks including 'Drilling', '002: Position grid', '003: Position grid', 'Tapping', '004: Position grid', '005: Position grid', and 'Engraving'.
- Right Panel:** A vertical menu with buttons for 'G functions', 'Auxiliary functions', 'Basic blocks', 'Time / counter', 'Program levels', and 'Act. values Machine'.
- Bottom Bar:** A row of icons for 'Over-store', 'Prog. cntrl.', 'Block search', 'Simult. record.', and 'Prog. corr.'.

Execute a program completely or only partially when **CYCLE START** key is selected.

Functions available are:

- **OVERSTORE** - Option of executing partial program information before the program is started.
- **PROGRAM CONTROL** – Allows different ways of testing & running the program.
- **BLOCK SEARCH** – Allows different methods of searching in a program
- **SIMULATION RECORD** – activate the simultaneous recording while machining the workpiece. You can select various display formats for the simultaneous recording.
- **PROGRAM CORRECTION** – Open the program to be edited, if needed
- **BASIC BLOCKS** – Displays both in test mode and when machining the workpiece on the machine. All G code commands that initiate a function on the machine are displayed on a side screen.
- **TIME / COUNTER** – Shows timing of running the current program; can be set up to keep count of workpieces.
- **PROGRAM LEVELS** - Displays the current program level during the execution of a large program with several subprograms.

KEYSWITCH INFORMATION

You can use the keyswitch to set various access rights.

The keyswitch has four settings for protection levels 4 to 7.

Machine data can be programmed to interlock access to programs, data, and functions at various protection levels.

The keyswitch has three keys of different colors that you can remove in the specified positions:

- Position 0 No key
 - Lowest access rights
 - Level of protection 7
 - End user, Semi-skilled operator
- Position 1 Key Black
 - Increasing access authorization
 - Level of protection 6
 - End user, Trained operator without programming knowledge
- Position 2 Key Green
 - Level of protection 5
 - End user, Skilled operator without programming knowledge
- Position 3 Key Red
 - Highest access rights
 - Level of protection 4
 - End user Programmer, Machine setter

When you change the key position to change the access authorization, this is immediately not visible on the operator interface.

You have to initiate an action first (e.g. close or open a directory).

The following table shows the password/key-switch positions and associated protection levels/users.

Protection level	Intended user:-	Protected via:-
1	Manufacturer	Password: SUNRISE
2	Service	Password: EVENING
3	User	Password: CUSTOMER
4	Programmer, Setter	Key-switch position 3
5	Qualified operator	Key-switch position 2
6	Trained operator	Key-switch position 1
7	Untrained operator	Key-switch position 0

The key switch is located to the bottom right of the MCP and has four positions. Three colour coded keys are available, each of which allow a different access level. This is from a standard Siemens machine control panel. It is possible that a manufacturer may use a different method to set the interface signal.



Key switch



Colour coded keys

Access levels of the three keys:

Key colour	Switch position	Protection level
No key required	0	7
Black	0 & 1	6-7
Green	0, 1 & 2	5-7
Orange	0, 1, 2 & 3	4-7

It is the responsibility of the OEM to ensure that the key-switch signals are transferred to the PLC interface.

DB2600.DBB0 is used for the transfer of the key-switch signals.

DB2600	Key-switch signals to NC (PLC → NC)							
	Bit7	Bit6	Bit5	Bit4	Bit3	Bit2	Bit1	Bit0
DBB0	Key-switch Pos.3	Key-switch Pos.2	Key-switch Pos.1	Key-switch Pos. 0				

Converting a Fanuc G Code Program for the 828 Control - Milling

% ← Remove symbol
O##### ← Remove program number
G291 ← Add this

N110G0G17G40G49G80G90

N120M6T1 ←

N130G0G90G54X-.5Y3.75S1069M3

N140G43H1Z.25

N150Z.1

N160G1Z-1.F15.

N170Y3.25F25.

N180G3X0.Y2.75R.5

N190G1X2.5

N200G2X2.75Y2.5R.25

N210G1Y-2.5

N220G2X2.5Y-2.75R.25

N230G1X-2.5

N240G2X-2.75Y-2.5R.25

N250G1Y2.5

N260G2X-2.5Y2.75R.25

N270G1X0.

N280G3X.5Y3.25R.5

N290G1Y3.75

N300Z-.9

N310G0Z.25

N320M5

N330G91G28Z0.

N340G28X0.Y0.

N350G90

N360M30

% ← Remove symbol

You will need to change your tool description names in the tool page to a number.
Do not use the letter "T" with the number.

NOTE: Also edit file extension to output .MPF format when saving.

AVAILABLE MILL CONTROL OPTIONS

DXF FILE IMPORT (Option)

The DXF-Reader function allows you to open files created in SINUMERIK Operate directly in a CAD system and accept and store contours as well as drilling positions directly in G-code and ShopMill programs.

- More detailed information is available in the Siemens 828 Milling Operating Manual, Section 6.11 – Working with DXF Files and in the SIEMENS DXF READER MANUAL on the USB provided with your machine.

RIGID TAPPING (Option)

You can machine an internal thread with the "tapping" cycle.

The tool moves to the safety clearance with the active speed and rapid traverse. The spindle stops, spindle and feedrate are synchronized. The tool is then inserted in the workpiece with the programmed speed (dependent on spindle RPM).

You can choose between drilling in one cut, chip breaking or retraction from the workpiece for swarf removal.

- More detailed information is available in the Siemens 828 Milling Operating Manual, Section 10.1.8 – Tapping.

RESIDUAL MATERIAL DETECTION (Option)

In Contour Milling when you have removed stock from a pocket (with/without islands) and there is residual material, then this is automatically detected.

You can use a suitable tool to remove this residual material without having to machine the whole pocket again, i.e. avoiding unnecessary nonproductive motion. The finishing allowance needs to be set identically for all machining steps because it does not count as residual material.

The residual material is calculated on the basis of the milling cutter used for stock removal.

- More detailed information is available in the Siemens 828 Milling Operating Manual, Section 10.3.11 – Residual Material Contour.

3D HIGH SPEED MACHINING (Option)

The High-Speed Settings function (CYCLE832) is used to preset data for the machining of 3D surfaces so that optimum machining is possible.

With the High-Speed Settings function, you can select between four technological machining types:

- Finishing
- Rough-finishing
- Roughing
- Deselected (default setting)

Machining of free-form surfaces involves high requirements for both velocity and precision and surface quality.

- More detailed information is available in the Siemens 828 Milling Operating Manual, Section 10.6.4 – High-Speed Settings (CYCLE832).

FOURTH AXIS SURFACE CYCLES (Option)

You require the Cylinder Surface Transformation to machine with a 4th axis equipped machine to do the following operations:

- Longitudinal machining on cylindrical bodies,
- Transverse machining on cylindrical objects,
- Machining with any path on cylindrical bodies.

The path of the machining is programmed with reference to the unwrapped, level surface of the cylinder (basically in 2D).

Programming can use line/circle, drilling or milling cycles or with contour milling (free contour programming).

- More detailed information is available in the Siemens 828 Milling Operating Manual, Section 10.7.6 – Cylinder Surface Transformation.

PRINTED REFERENCE MANUALS INCLUDED WITH YOUR MACHINE

MC, VB, HR, HB, TC - 828 MAINTENANCE MANUAL
828 JOB SHOP & PRODUCTION MILL OPERATOR MANUAL

REFERENCE MANUALS ON A USB INCLUDED WITH YOUR MACHINE

- **SINUTRAIN MILLING MADE EASY WITH SHOPMILL**
 - This training manual guides you through the basics of SHOPMILL which allows quick and practical programming of machining. Includes step by step instructions how to program sample parts.
- **SIEMENS 828 MILLING OPERATING MANUAL**
 - This operating manual covers in detail the available control elements and programming. More advanced than the MILLING MADE EASY WITH SHOPMILL manual.
- **SIEMENS G CODE PROGRAMMING MANUAL - MILLING**
 - This programming manual covers in detail utilizing ISO G-Code programming.
- **SIEMENS DXF READER MANUAL**
 - This manual steps through the setup and use of DXF files in the control. **(Option)**
- **SIEMENS OFFLINE SOFTWARE MANUAL**
 - This manual guides you through the basic of installing and using SINUTRAIN offline programming software which allows quick programming on a computer. **(Option)**
- **SIEMENS 828 ALARMS MANUAL**
 - This diagnostics manual enables the users to evaluate alarm errors and fault indications and how to respond accordingly.

Disclaimer

We have reviewed the contents of this publication to ensure consistency with the hardware and software described.

Since variance cannot be precluded entirely, we cannot guarantee full consistency. However, the information in this publication is reviewed regularly and any necessary corrections are included in subsequent editions.

FRYER MACHINE SYSTEMS

The Toolroom Company

Phone: 845-878-2500

Fax: 845-878-2525

Email: info@fryermachine.com

sales@fryermachine.com

Website: www.fryermachine.com

© 2020 Fryer Machine Systems. Inc.
70 Jon Barrett Road Patterson, New York 12563 USA